



KEYLIGHT

Welcome to Keylight International

The right key to your project.

T
KEY

Keylight International B.V. is an international leading supplier of LED lighting solutions for professional indoor and outdoor lighting applications.

“The right advice and fast delivery is top priority”

For many years, Keylight has developed standard and customized lighting solutions, with the aim to respect the design, ergonomics, economic efficiency and energy reduction. This gives us the extra value. Keylight has an international customer base. Our customers exist of distributors, importers and project designers in the Netherlands, Europe and beyond. We produce LED luminaires for use within all kinds of public area's such as offices, banks, shops, shopping malls, parkings, hospitality and residential area's and outdoor LED luminaires designed to illuminate buildings, car-parks, petrol stations and parks. With the skillful combination of modern design, functionality and excellent lighting parameters we are able to compete with the biggest world leading lighting companies.

Located in Nijkerk, the Netherlands, Keylight employs a skilled team of lighting experts who are able to help our customers projects reach new heights in energy saving solutions and implementing the latest developments in LED technology against competitive prices. The right advice and fast delivery is top priority.

Keylight is committed to a Customer First attitude and provide the right service in fulfilling customer needs. We resolve to provide outstanding service before and after the sale, and take part in maintaining long term relationships with our customers. Together with our sales partners, from product selection and specification through delivery and beyond.

www.key-light.nl/aboutus



Hospitality & Hotel

Our hospitality products can add value in many different ways. See what hospitality lighting can do for your guests.

Keylight provides flexible lighting solutions that empower guests to personalise their spaces, adjust environments according to moods or activities and create a unique experience. Lighting energises us, makes us comfortable and allows us to enjoy interacting with others. Whether they're working, reading or relaxing, we can help your guests feel like they have a home away from home. We can help you make the switch to LED easier than you could possibly imagine, enhancing life in your hotel, bar or restaurant with the power of light.

Retail

The right light makes your products sell itself and appear more attractive in a retail environment.

we can offer a variety of LED light luminaires and a complementary range of electronic drivers for retail lighting, from downlights, spotlights to linear fixtures, each with their own, unique proposition and features designed around specific retail lighting applications. Dependent on the application, different elements come in to play, such as energy efficiency, color rendering ability, the correct color temperature, whiteness, color saturation or dynamic lighting.



Office & Industry

Choosing the right lighting solution for the office or industry segment can be a challenge.

Luckily Keylight offers a wide variety of LED solutions like linear lighting, downlighting, highbay luminaires and many more. Thanks to our assortment of many different LED modules, all with their unique specifications like color temperature, DALI Dimmable options, high energy efficiency, CRI and lumen, our customers can customize their needs with special made designs. Whether you need simple or high output luminaires for industrial usage, our luminaires can be tailored to your demand.

Outdoor

Light up the darkness with our powerful LED outdoor luminaires.

Our outdoor luminaires are applicable in many different ways. Gardenspots with a warm color temperature or high power downlights for gasstations, wall luminaires, park luminaires, floor recessed spots to highlight or illuminate buildings, or natural elements such as trees, hedges or ponds. Every luminaire integrates seamlessly with any outdoor environment.

High-quality light Philips SLM G4

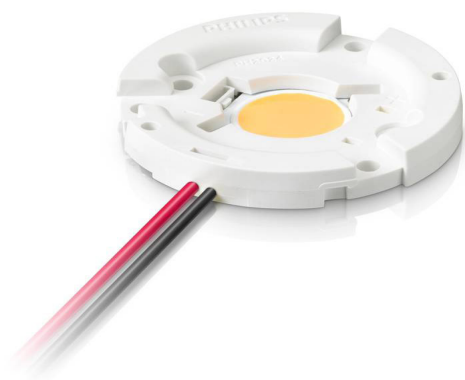

Philips SLM G4

The new standard in lighting.

The Fortimo LED SLM Gen4 offers a high quality of light and the opportunity to operate the system at high lumen per Watt to optimize luminaire design, or at high lumen output for optimum economic performance.



Quality of light, minimum maintenance.

High quality of light for spot and downlights

Lighting makes merchandise, brands and businesses shine. It empowers the retailer to use light to its full potential, creating maximum impact.

The Fortimo LED SLM Gen4 product range offers customers the flexibility they are looking for: a choice between high quality of light, high efficacy (lm/W) and lowest luminaire costs (lm/€). Each module is interchangeable so that within one luminaire range, lighting can be tuned to the retailer's needs. Without doubt, quality of light is of utmost importance for retail lighting; retailers cannot afford to make any compromises.

With the introduction of the fourth generation of Fortimo LED SLM, Philips presents a complete product range with the ideal combination of quality of light and state-of-the-art efficacy. Fortimo LED SLM is now a perfect alternative for traditional MASTERColour CDM light sources. The Fortimo LED SLM Gen4 product range includes dedicated solutions.

Fortimo LED SLM Food Warm White and Fortimo LED SLM Food Premium Red are dedicated solutions for retail food applications that enhance the unique appearance of fresh foods and meat. The flagship product for retail fashion applications is the CrispWhite. It offers unparalleled rendering of rich colors and crisp whites from one light source, resulting in a totally new color experience.

Benefits for end users

- Attractive and desirable merchandise
- Reduced re-lamping cycles
- High-efficiency design to minimize energy usage
- Closer illumination possible because of minimized UV and IR
- Dynamic displays possible with dimming to 10%

Applications

- Retail:
Accent, display, track lighting, and mini floodlighting
- Hospitality:
Lobbies, reception areas, and restaurants
- Recreation:
Museums, galleries, and theatres

* Average rated life is based on engineering data testing and probability analysis. The hours are at the B50, L70 point (50,000 hours life with 70% lumen maintenance).



Meat & fish

Fortimo LED SLM Food Premium Red are dedicated solutions for retail food applications that enhance the unique appearance of fresh foods and meat.

Fortimo LED SLM Premium Red

The Fortimo LED SLM Premium Red is developed with a tuned color spectrum that enhances red and simultaneously displays white in a clear and fresh way. It creates an impactful contrast between the two colors, which visually impacts the appearance of fresh meat and fish.



Bread, fruit & vegetables

Light that highlights the reds in tomatoes or the warm brown yellow colors in fresh bread can have a great impact on shoppers eyes and creating an almost mouthwatering effect.

Fortimo LED SLM Warm White

The Fortimo LED SLM Warm White creates a unique color impression that makes fresh food such as fruit and vegetables as well as bread look incredibly attractive. It brings out the natural brilliance of greens, reds and yellows, in fact all colors. Colors appear warm and saturated, exactly what a retailer looks for when displaying fresh produce. Besides fresh produce it is also a fantastic light source to bring out the warm colors of wood, leather displays.





“It’s the first retail LED light solution to make whites appear pure and bright at the same time as making other colors appear warm, saturated and intense”



Introducing Fortimo SLM CrispWhite for retail.

For retail light applications, it's essential that the colors of materials, clothes and other fabrics appear rich and intense. But until now, LED light sources with a warm color temperature that made a vivid color palette look so desirable, also made whites look off-white, creamy or yellowish in appearance. Now you can have the best of both worlds with Fortimo SLM CrispWhite - a new innovation in retail lighting from Philips.

A unique color experience

Fortimo SLM CrispWhite is a unique solution that offers an unparalleled rendering of white and colors within one light source. It's the first retail LED light solution to make whites appear pure and bright at the same time as making other colors appear warm, saturated and intense.

Think of two color temperature contrasts within a single lamp - 4000 K for whites and 3000 K for colors. The result is an extremely attractive display that presents shoppers with a totally new color experience. One that shows all a store's merchandise in its best light. Fortimo SLM CrispWhite creates the most attractive retail experience with authentic rendering to bring out the true colors in merchandise.

- Benchmark color points in spot lighting
- The highest brightness and the tightest beams
- CRI > 90 for deep, rich colors

A smart system for spotlights

Fortimo SLM CrispWhite is designed to work with Xitanium LED drivers, a smart system approach that offers:

- Optimized system performance, maximum flexibility
- Dimming systems such as Touch & Dim and DALI for scene setting and additional energy savings
- Easy design-in possibilities with extended Tc up to 95 °C for further miniaturization
- REACH and RoHS certified for quick and easy luminaire approbation

CrispWhite light everywhere

Fortimo SLM CrispWhite is suitable for the two main applications in retail lighting. Designed to be used in accent spotlights or general downlighting, it creates color consistency across all light sources in store. It means retailers can enjoy all the advantages of LED such as high energy efficiency, outstanding light quality and a long lifetime. But with the added benefit of enhanced rendering for both whites and colors - something that, until now, has only been possible with conventional light sources.

Ordering a product is as easy as 1,2,3.

Ordering products at Keylight is made easy with 6 simple steps. We like things short and straight forward.

01

Select a luminaire

Select your luminaire and colour of choice by using the article number and colourcode.

02

Select the type of LED

Select which type of LED source you like to add.

03

Options & extra's

Add optional accessoires or functionalities to your luminaire.

04

Select shipping method

We offer a wide range of shipping possibilities, whether it's by air, sea or land, urgent shipping, by courier, Keylight has the solution for you.

05

Ordering your product

You can place an order by using:

Email: sales@key-light.nl
Phone: +31 (0)33 - 2462021

06

That's all!

Once your order has been placed, we will confirm the order by email. We'll take care of a smooth delivery.

Content

Information Index

| | |
|------------------------|----|
| Welcome to keylight | 2 |
| Area's of application | 4 |
| High quality light | 6 |
| Lighting for food | 8 |
| Crisp White for retail | 10 |
| Ordering a product | 12 |
| Content | 13 |

Interior luminaires

| | |
|----------------------|----|
| Recessed Circular | 12 |
| Recessed Square | 88 |
| Surface Circular | 88 |
| Surface Square | 88 |
| Track Lighting | 88 |
| Profile Systems | 88 |
| Pendent Luminaires | 88 |
| Wall Luminaires | 88 |
| Stripes & Ledlines | 88 |
| Emergency Luminaires | 88 |

Exterior luminaires

| | |
|---|----|
| Exterior Recessed & Surface circular & square | 88 |
| Exterior Wall luminaires | 88 |
| Outdoor luminaires | 88 |



Recessed Circular





CABINET
PAGE 18



BINNY
PAGE 19



BINNY D
PAGE 20



BAN 9
PAGE 21



GHIBLI R
PAGE 22



DEEP 10
PAGE 26



CAP R1
PAGE 27



CAP R2
PAGE 28



ALASKA
PAGE 29



CIRC 10
PAGE 30



JIVE 40
PAGE 34



YORK 13
PAGE 35



HELIX 14
PAGE 36



ROLED
PAGE 37



MONACO 15
PAGE 38



NOVA
PAGE 42



UTAH 18
PAGE 43



PLUTO 18 - 20
PAGE 44 - 45



STAR 18 - 28
PAGE 46 - 47



MOON 17
PAGE 48



NOX 20 R
PAGE 52



SOLAR 18
PAGE 53



SOLAR 22
PAGE 54



GALAXY
PAGE 55



JEEP 22
PAGE 56



GHIBLI R TRIM
PAGE 23



STICK
PAGE 24



STICK TRIM
PAGE 25



CIRC 13
PAGE 31

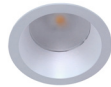

JIVE 13
PAGE 32



JIVE 30
PAGE 33



MONACO 20
PAGE 39



VISION 15
PAGE 40



VISION 20
PAGE 41



MOON 22
PAGE 49



MOON 27
PAGE 50



NOX 18 R
PAGE 51

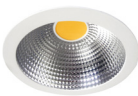

MARS 22
PAGE 57



AUSTIN 32
PAGE 58



AUSTIN 58
PAGE 59

Recessed Circular

| | |
|---------------|--------------|
| ALASKA | PAGE 29 |
| AUSTIN LED 32 | PAGE 58 |
| AUSTIN LED 58 | PAGE 59 |
| BAN | PAGE 21 |
| BINNY | PAGE 19 |
| BINNY D | PAGE 20 |
| CABINET | PAGE 18 |
| CAP R1 | PAGE 27 |
| CAP R2 | PAGE 28 |
| CIRC 10 | PAGE 30 |
| CIRC 13 | PAGE 31 |
| DEEP 10 | PAGE 26 |
| GALAXY | PAGE 55 |
| GHIBLI R | PAGE 22 |
| GHIBLI R TRIM | PAGE 23 |
| HELIX 14 | PAGE 36 |
| JEEP 22 | PAGE 56 |
| JIVE 13 | PAGE 32 |
| JIVE 30 | PAGE 33 |
| JIVE 40 | PAGE 34 |
| MARS 22 | PAGE 57 |
| MONACO 15 | PAGE 38 |
| MONACO 20 | PAGE 39 |
| MOON 17 | PAGE 48 |
| MOON 22 | PAGE 49 |
| MOON 27 | PAGE 50 |
| NOVA | PAGE 42 |
| NOX 18 R | PAGE 51 |
| NOX 20 R | PAGE 52 |
| PLUTO 18 - 20 | PAGE 44 - 45 |
| ROLED | PAGE 37 |
| SOLAR 18 | PAGE 53 |
| SOLAR 22 | PAGE 54 |
| STAR 18 - 28 | PAGE 46 - 47 |
| STICK | PAGE 24 |
| STICK TRIM | PAGE 25 |
| UTAH 18 | PAGE 43 |
| VISION 15 | PAGE 40 |
| VISION 20 | PAGE 41 |
| YORK 13 | PAGE 35 |

TECHNICAL INFORMATION

CABINET



- PRODUCT MATERIAL ▶ Nickel
- LIGHT SOURCE ▶ LED TW
- MODULE LIFETIME ▶ Approx. 25.000 Hours
- LED COOLING ▶ Passive cooling
- DRIVER ▶ Included.
- COLORS ▶ ● 80 = Nickel
- BEAM ANGLE ▶ 60°
- REFLECTOR ▶ n/a
- ADJUSTABLE ▶ No
- SIZE ▶ 65 X 16MM

OPTIONS

- DRIVER WITH PLUG ▶ 12v DC 18W + 6-way distributor € 30,00
art. no.: 2014.170.18.5
- DRIVER ▶ 12V DC 30W + 6-way distributor € 40,00
art. no.: 2014.171.30.5
- DRIVER ▶ 12v DC 70W DIM € 45,00
art. no.: 2014.172.70.5
- DISTRIBUTOR ▶ 6-way distributor block € 7,25
art. no.: 2014.173.06.5

INFORMATION

WARRANTY ▶ 2 Years.

This luminaire is "plug & play".

Incl. driver, cable and plug.

Keylight International B.V. reserves the right to modify or change technical, construction or LED specifications due to continuous improvements of our products and lightsources.



CABINET

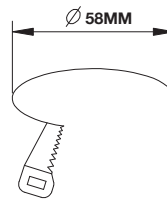

Hole size

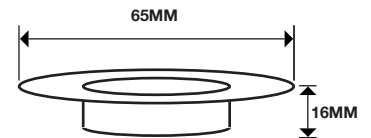

Technical drawing

| ARTICLE NO. | LAMP TYPE | BRAND | LIGHT OUTPUT | MODULE POWER | MODULE EFFICIENCY | CORRELATED COLOUR TEMPERATURE | COLOUR RENDERING INDEX | TC LIFE | SALES PRICE |
|---------------|-----------|-------|--------------|--------------|-------------------|-------------------------------|------------------------|---------|-------------|
| | | | LM | W | LM/W | K | RA | HRS | EURO |
| 2014.160.27.8 | LED TW | TW | - | 3 | 92 | 2700 | >80 | 25.000 | € 23,50 |
| 2014.150.30.8 | LED TW | TW | - | 3 | 92 | 3000 | >80 | 25.000 | € 23,50 |

TECHNICAL INFORMATION

BINNY



- PRODUCT MATERIAL** ▶ Die-cast Aluminium
- LIGHT SOURCE** ▶ CXA 1512
- MODULE LIFETIME** ▶ Approx. 25.000 Hours
- LED COOLING** ▶ Passive cooling
- DRIVER** ▶ Philips driver Included
- COLORS** ▶ ● 3 = RAL 9003 white
- BEAM ANGLE** ▶ 60°
- REFLECTOR** ▶ White
- ADJUSTABLE** ▶ Yes
- SIZE** ▶ 85 X 73MM

INFORMATION

- WARRANTY** ▶ 2 Years.

This luminaire is "plug & play".

Incl. 1.5m cable and plug.

Keylight International B.V. reserves the right to modify or change technical, construction or LED specifications due to continuous improvements of our products and lightsources.



BINNY

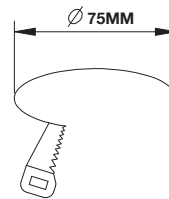

Hole size

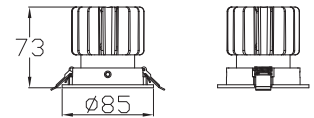

Technical drawing

| ARTICLE NO. | LAMP TYPE | BRAND | LIGHT OUTPUT | MODULE POWER | MODULE EFFICIENCY | CORRELATED COLOUR TEMPERATURE | COLOUR RENDERING INDEX | TC LIFE | MA | SALES PRICE |
|---------------|-----------|-------|--------------|--------------|-------------------|-------------------------------|------------------------|---------|-----|-------------|
| | | | LM | W | LM/W | K | RA | HRS | | EURO |
| 4102.999.60.3 | CXA 1512 | Cree | 1200 | 13 | 92 | 3000 | >80 | 25.000 | 350 | € 70,00 |

TECHNICAL INFORMATION

PRODUCT

BINNY D



- PRODUCT MATERIAL** ▶ Die-cast Aluminium
- LIGHT SOURCE** ▶ CXA 1512
- MODULE LIFETIME** ▶ Approx. 25.000 Hrs.
- LED COOLING** ▶ Passive cooling
- DRIVER** ▶ Philips driver Included.
- COLORS** ▶ ● 3 = RAL 9003 white
- BEAM ANGLE** ▶ 60°
- REFLECTOR** ▶ White
- ADJUSTABLE** ▶ No
- SIZE** ▶ 88 X 97MM

INFORMATION

- WARRANTY** ▶ 2 Years.

This luminaire is "plug & play".

Incl. 1.5m cable and plug.

Keylight International B.V. reserves the right to modify or change technical, construction or LED specifications due to continuous improvements of our products and lightsources.



BINNY D

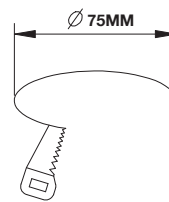

Hole size

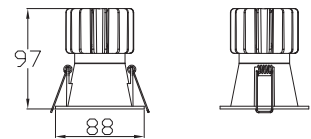

Technical drawing

| ARTICLE NO. | LAMP TYPE | BRAND | LIGHT OUTPUT | MODULE POWER | MODULE EFFICIENCY | CORRELATED COLOUR TEMPERATURE | COLOUR RENDERING INDEX | TC LIFE | MA | SALES PRICE |
|---------------|-----------|-------|--------------|--------------|-------------------|-------------------------------|------------------------|---------|-----|-------------|
| | | | LM | W | LM/W | K | RA | HRS | | EURO |
| 4103.999.60.3 | CXA 1512 | Cree | 1200 | 13 | 92 | 3000 | >80 | 25.000 | 350 | € 65,00 |

TECHNICAL INFORMATION

PRODUCT

BAN 9



- PRODUCT MATERIAL** ▶ Aluminium
- LIGHT SOURCE** ▶ MR16 LED / LMR50
- DRIVER** ▶ LMR 50 includes a driver
- COLORS** ▶
 - 3 = RAL 9003 white
 - 5 = RAL 9005 black
 - 6 = RAL 9006 alu
- BEAM ANGLE** ▶ LMR: 20° / 30°
- ADJUSTABLE** ▶ Yes
- SIZE** ▶ 92 X 70MM **OR INCL. LMR 92X 90MM**

OPTIONS LMR

- GLASS COVER CLEAR** ▶ Glass IP44 € 7,50
art. no.: 0053.999.99.0
- GLASS FILTER** ▶ Filter 2600K glass € 30,00
art. no.: 4006.999.27.0
- DIMMABLE DRIVER IN COMBINATION WITH BAN 9** ▶
 - OSRAM 8.5W 1/10v 350mA € 23,50
art. no.: 0110.999.99.0
 - OSRAM 13W phase-cut 350 mA € 23,50
art. no.: 0111.999.99.0

INFORMATION

LMR including cable, plug, connection cable and driver.



Only luminaire body, lightsource and/or driver excluded.

Keylight International B.V. reserves the right to modify or change technical, construction or LED specifications due to continuous improvements of our products and lightsources.



BAN 9

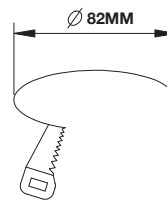

Hole size

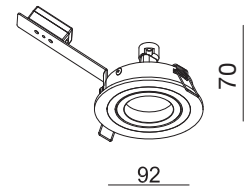

Technical drawing



LMR50

| ARTICLE NO. | LAMP TYPE | BRAND | LIGHT OUTPUT | MODULE POWER | MODULE EFFICIENCY | CORRELATED COLOUR TEMPERATURE | COLOUR RENDERING INDEX | TC LIFE | REFL. | mA | SALES PRICE |
|----------------|-----------|-----------|--------------|--------------|-------------------|-------------------------------|------------------------|---------|--------|-----|-------------|
| Δ see colors | | | LM | W | LM/W | K | RA | HRS | DEGREE | mA | EURO |
| ! 4545.999.98Δ | Gu5.3 | | | Max. 50W | | | | | | | € 23,50 |
| ! 4545.999.98Δ | Gu10 | | | Max. 50W | | | | | | | € 23,50 |
| 4545.171.20Δ | LMR50 | Bridgelux | 560 | 6.6 | 79 | 2700 | >80 | 25.000 | 20° | 350 | € 70,00 |
| 4545.172.30Δ | LMR50 | Bridgelux | 560 | 6.6 | 79 | 2700 | >80 | 25.000 | 30° | 350 | € 70,00 |
| 4545.173.20Δ | LMR50 | Bridgelux | 600 | 6.6 | 86 | 3000 | >80 | 25.000 | 20° | 350 | € 70,00 |
| 4545.174.30Δ | LMR50 | Bridgelux | 600 | 6.6 | 86 | 3000 | >80 | 25.000 | 30° | 350 | € 70,00 |

TECHNICAL INFORMATION

PRODUCT

GHIBLI R



- PRODUCT MATERIAL** ▶ Die-cast aluminium
- LIGHT SOURCE** ▶ Bridgelux V8
- DRIVER** ▶ Including driver
- COLORS** ▶
 - 35 = RAL 9003 white + black
 - 5 = RAL 9005 black
 - 7 = RAL 7037 grey
- BEAM ANGLE** ▶ 26°
- ADJUSTABLE** ▶ Yes
- SIZE** ▶ 90 X 120MM

OPTIONS

- OPTIONAL BEAM ANGLE** ▶ 38°Reflector € 5,00
art. no.: 4912.999.38.9
- REFLECTOR RING** ▶ White reflector ring € 9,50
art. no.: 4912.922.99.3
Black reflector ring € 9,50
art. no.: 4912.922.99.5
Gold reflector ring € 9,50
art. no.: 4912.922.99.9
- GLASS** ▶ Transparent € 7,50
art. no.: 4912.933.99.0
Honey Comb € 7,50
art. no.: 4912.933.94.0
Frosted € 7,50
art. no.: 4912.933.90.0
Striped € 7,50
art. no.: 4912.933.96.0
- DIMMABLE DRIVER IN COMBINATION WITH GHIBLI R** ▶
 - OSRAM 8,5W 1/10v 350mA € 23,50
art. no.: 0110.999.99.0
 - OSRAM 13W Leading & trailing edge € 23,50
art. no.: 0111.999.99.0
 - Lumotech 20W 1/10v 500mA € 27,50
art. no.: 0137.999.99.0
 - Lumotech 12W Mains trailing edge 500mA € 27,50
art. no.: 0135.500.99.0

INFORMATION

Including cable and plug

Keylight International B.V. reserves the right to modify or change technical, construction or LED specifications due to continuous improvements of our products and lightsources.



GHIBLI R

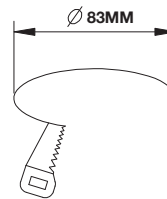

Hole size

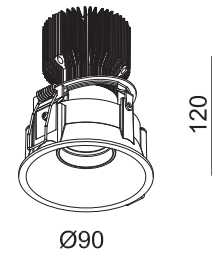

Technical drawing

| ARTICLE NO. | LAMP TYPE | BRAND | LIGHT OUTPUT | MODULE POWER | MODULE EFFICIENCY | CORRELATED COLOUR TEMPERATURE | COLOUR RENDERING INDEX | TC LIFE | mA | SALES PRICE |
|---------------|-----------|-----------|--------------|--------------|-------------------|-------------------------------|------------------------|---------|-----|-------------|
| Δ see colors | | | LM | W | LM/W | K | RA | HRS | mA | EURO |
| 4915.179.26.Δ | V8 LED | Bridgelux | 565 | 6 | 91 | 2700 | >90 | 50.000 | 350 | € 95,00 |
| 4915.180.26.Δ | V8 LED | Bridgelux | 675 | 9 | 84 | 2700 | >90 | 50.000 | 500 | € 95,00 |

TECHNICAL INFORMATION

PRODUCT

GHIBLI R TRIM



- PRODUCT MATERIAL** ▶ Die-cast aluminium
- LIGHT SOURCE** ▶ Bridgelux V8
- DRIVER** ▶ Including driver
- COLORS** ▶
 - 35 = RAL 9003 white + black
 - 5 = RAL 9005 black
 - 7 = RAL 7037 grey
- BEAM ANGLE** ▶ 26°
- ADJUSTABLE** ▶ Yes
- SIZE** ▶ 85 X 120MM

OPTIONS

- OPTIONAL BEAM ANGLE** ▶ 38° Reflector € 5,00
art. no.: 4912.999.38.9
- REFLECTOR RING** ▶ White reflector ring € 9,50
art. no.: 4912.922.99.3
Black reflector ring € 9,50
art. no.: 4912.922.99.5
Gold reflector ring € 9,50
art. no.: 4912.922.99.9
- GLASS** ▶ Transparent € 7,50
art. no.: 4912.933.99.0
Honey Comb € 7,50
art. no.: 4912.933.94.0
Frosted € 7,50
art. no.: 4912.933.90.0
Striped € 7,50
art. no.: 4912.933.96.0
- DIMMABLE DRIVER IN COMBINATION WITH GHIBLI R TRIM** ▶ OSRAM 8.5W 1/10v 350mA € 23,50
art. no.: 0110.999.99.0
OSRAM 13W Leading & trailing edge € 23,50
art. no.: 0111.999.99.0
Lumotech 20W 1/10v 500mA € 27,50
art. no.: 0137.999.99.0
Lumotech 12W Mains trailing edge 500mA € 27,50
art. no.: 0135.500.99.0

INFORMATION

Including cable and plug

INCLUDING MOUNTING KIT. SIZE 114 X 150MM

Keylight International B.V. reserves the right to modify or change technical, construction or LED specifications due to continuous improvements of our products and lightsources.



GHIBLI R TRIM

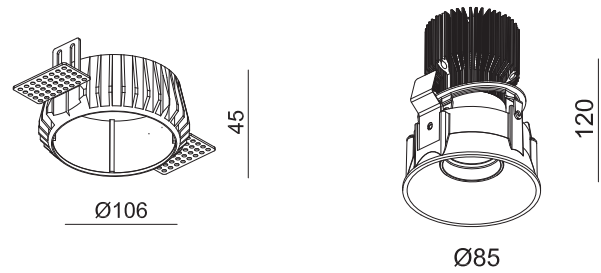

Hole size = 114mm

Technical drawing

| ARTICLE NO. | LAMP TYPE | BRAND | LIGHT OUTPUT | MODULE POWER | MODULE EFFICIENCY | CORRELATED COLOUR TEMPERATURE | COLOUR RENDERING INDEX | TC LIFE | mA | SALES PRICE |
|---------------|-----------|-----------|--------------|--------------|-------------------|-------------------------------|------------------------|---------|-----|-------------|
| Δ see colors | | | LM | W | LM/W | K | RA | HRS | mA | EURO |
| 4916.179.26.Δ | V8 LED | Bridgelux | 565 | 6 | 91 | 2700 | >90 | 50.000 | 350 | € 110,00 |
| 4916.180.26.Δ | V8 LED | Bridgelux | 675 | 9 | 84 | 2700 | >90 | 50.000 | 500 | € 110,00 |

TECHNICAL INFORMATION

PRODUCT

STICK



- PRODUCT MATERIAL** ▶ Die-cast aluminium
- LIGHT SOURCE** ▶ Bridgelux V6
- DRIVER** ▶ Including Philips driver
- COLORS** ▶
 - 35 = RAL 9003 white + black
 - 5 = RAL 9005 black
 - 7 = RAL 7037 grey
- BEAM ANGLE** ▶ 26°
- ADJUSTABLE** ▶ Yes
- SIZE** ▶ 90 X 85MM

OPTIONS

- OPTIONAL BEAM ANGLE** ▶ 38° Reflector € 5,00
art. no.: 4912.999.38.9
- REFLECTOR RING** ▶ White reflector ring € 9,50
art. no.: 4912.922.99.3
Black reflector ring € 9,50
art. no.: 4912.922.99.5
Gold reflector ring € 9,50
art. no.: 4912.922.99.9
- DIMMABLE DRIVER IN COMBINATION WITH STICK** ▶ Lumotech 20W 1/10v 700mA € 23,50
art. no.: 0110.999.99.0
Lumotech 12W Trailing edge 700Ma € 27,50
art. no.: 0111.999.99.0

INFORMATION

Including cable and plug

Keylight International B.V. reserves the right to modify or change technical, construction or LED specifications due to continuous improvements of our products and lightsources.



STICK

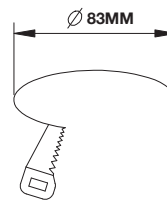

Hole size

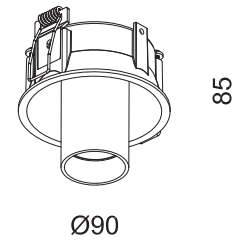

Technical drawing

| ARTICLE NO. | LAMP TYPE | BRAND | LIGHT OUTPUT | MODULE POWER | MODULE EFFICIENCY | CORRELATED COLOUR TEMPERATURE | COLOUR RENDERING INDEX | TC LIFE | mA | SALES PRICE |
|---------------|-----------|-----------|--------------|--------------|-------------------|-------------------------------|------------------------|---------|-----|-------------|
| Δ see colors | | | LM | W | LM/W | K | RA | HRS | mA | EURO |
| 4917.179.26.Δ | V6 LED | Bridgelux | 250 | 3.1 | 91 | 2700 | >90 | 50.000 | 350 | € 90,00 |
| 4917.180.26.Δ | V6 LED | Bridgelux | 465 | 6.8 | 78 | 2700 | >90 | 50.000 | 700 | € 90,00 |

TECHNICAL INFORMATION

PRODUCT

STICK TRIM



- PRODUCT MATERIAL** ▶ Die-cast aluminium
- LIGHT SOURCE** ▶ Bridgelux V6
- DRIVER** ▶ Including Philips driver
- COLORS** ▶
 - 35 = RAL 9003 white + black
 - 5 = RAL 9005 black
 - 7 = RAL 7037 grey
- BEAM ANGLE** ▶ 26°
- ADJUSTABLE** ▶ Yes
- SIZE** ▶ 85 X 100MM

OPTIONS

- OPTIONAL BEAM ANGLE** ▶ 38° Reflector € 5,00
art. no.: 4912.999.38.9
- REFLECTOR RING** ▶ White reflector ring € 9,50
art. no.: 4912.922.99.3
Black reflector ring € 9,50
art. no.: 4912.922.99.5
Gold reflector ring € 9,50
art. no.: 4912.922.99.9
- DIMMABLE DRIVER** ▶ Lumotech 20W 1/10v 700mA € 23,50
art. no.: 0110.999.99.0
Lumotech 12W Trailing edge 700Ma € 27,50
art. no.: 0111.999.99.0

INFORMATION

Including cable and plug

INCLUDING MOUNTING KIT. SIZE 106 X 45MM

Keylight International B.V. reserves the right to modify or change technical, construction or LED specifications due to continuous improvements of our products and lightsources.



STICK TRIM

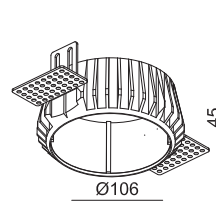

Hole size 114mm

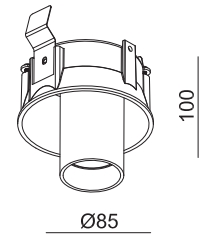

Technical drawing

| ARTICLE NO. | LAMP TYPE | BRAND | LIGHT OUTPUT | MODULE POWER | MODULE EFFICIENCY | CORRELATED COLOUR TEMPERATURE | COLOUR RENDERING INDEX | TC LIFE | mA | SALES PRICE |
|---------------|-----------|-----------|--------------|--------------|-------------------|-------------------------------|------------------------|---------|-----|-------------|
| Δ see colors | | | LM | W | LM/W | K | RA | HRS | mA | EURO |
| 4918.179.26.Δ | V6 LED | Bridgelux | 250 | 3.1 | 91 | 2700 | >90 | 50.000 | 350 | € 105,00 |
| 4918.180.26.Δ | V6 LED | Bridgelux | 465 | 6.8 | 78 | 2700 | >90 | 50.000 | 700 | € 105,00 |

TECHNICAL INFORMATION

PRODUCT

DEEP 10



- PRODUCT MATERIAL ▶ Aluminium
- LIGHT SOURCE ▶ MR16 LED / LMR50
- DRIVER ▶ LMR 50 includes a driver
- COLORS ▶
 - 3 = RAL 9003 white
 - 5 = RAL 9005 black
 - 6 = RAL 9006 alu
- BEAM ANGLE ▶ LMR: 20° / 30°
- ADJUSTABLE ▶ Yes
- SIZE ▶ 98 X 65MM OR INCL. LMR 98 X 90MM

OPTIONS LMR

- DIMMABLE DRIVER IN COMBINATION WITH DEEP 10 ▶
 - OSRAM 8.5W 1/10v 350mA € 23,50
art. no.: 0110.999.99.0
 - OSRAM 13W phase-cut 350 mA € 23,50
art. no.: 0111.999.99.0
- OPTIONAL FRONT RING ▶ LMR50 Aluminium colour. € 3,95
art. no.: 0052.999.99.6
- MOUNTING BRACKET ▶ LMR50 incl. mounting set € 5,00
art. no.: 0051.999.99.5
- GLASS COVER CLEAR ▶ LMR50 glass IP44 € 7,50
art. no.: 0053.999.99.0

INFORMATION

LMR including cable, plug, connection cable and driver.



Only luminaire body, lightsource and/or driver excluded.

Keylight International B.V. reserves the right to modify or change technical, construction or LED specifications due to continuous improvements of our products and lightsources.



DEEP 10

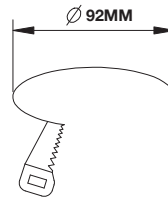

Hole size

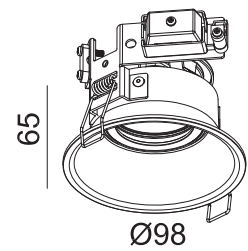

Technical drawing



LMR50

| ARTICLE NO. | LAMP TYPE | BRAND | LIGHT OUTPUT | MODULE POWER | MODULE EFFICIENCY | CORRELATED COLOUR TEMPERATURE | COLOUR RENDERING INDEX | TC LIFE | REFL. | mA | SALES PRICE |
|----------------|-----------|-----------|--------------|--------------|-------------------|-------------------------------|------------------------|---------|--------|-----|-------------|
| Δ see colors | | | LM | W | LM/W | K | RA | HRS | DEGREE | mA | EURO |
| ! 4010.999.98Δ | Gu5.3 | | | Max. 50W | | | | | | | € 25,00 |
| ! 4010.999.98Δ | Gu10 | | | Max. 50W | | | | | | | € 25,00 |
| 4010.171.20Δ | LMR50 | Bridgelux | 560 | 6.6 | 79 | 2700 | >80 | 25.000 | 20° | 350 | € 70,00 |
| 4010.172.30Δ | LMR50 | Bridgelux | 560 | 6.6 | 79 | 2700 | >80 | 25.000 | 30° | 350 | € 70,00 |
| 4010.173.20Δ | LMR50 | Bridgelux | 600 | 6.6 | 86 | 3000 | >80 | 25.000 | 20° | 350 | € 70,00 |
| 4010.174.30Δ | LMR50 | Bridgelux | 600 | 6.6 | 86 | 3000 | >80 | 25.000 | 30° | 350 | € 70,00 |

TECHNICAL INFORMATION

PRODUCT

CAP R1



- PRODUCT MATERIAL** ▶ Die-cast aluminium
- LIGHT SOURCE** ▶ Bridgelux
- MODULE LIFETIME** ▶ Approx. 50.000 hours
- LED COOLING** ▶ Passive cooling
- DRIVER** ▶ Incl. driver + cable and plug standard
- COLORS (Δ)** ▶
 - 3 = RAL 9003 white
 - 5 = RAL 9005 black
 - 6 = RAL 9006 alu
- BEAM ANGLE** ▶ 28°
- ADJUSTABLE** ▶ Yes
- SIZE** ▶ 105 X 77MM

OPTIONS

- GLASS COVER CLEAR** ▶ Glass IP44 € 7,50
art. no.: 0053.999.99.0
- GLASS FILTER** ▶ Filter 2600K glass € 30,00
art. no.: 4006.999.27.0
- DIMMABLE DRIVER IN COMBINATION WITH CAP R1** ▶
 - OSRAM 8.5W 1/10v 350mA € 23,50
art. no.: 0110.999.99.0
 - OSRAM 13W phase-cut 350 mA € 23,50
art. no.: 0111.999.99.0

INFORMATION

- WARRANTY** ▶ 5 Years

Δ = product color code. See colors
This luminaire is "plug & play".
Incl. 1.5m cable and plug.

Keylight International B.V. reserves the right to modify or change technical, construction or LED specifications due to continuous improvements of our products and lightsources.



CAP R1

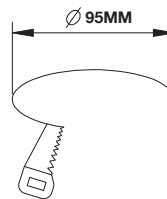

Hole size

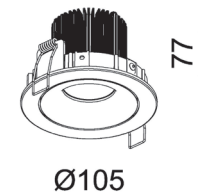

Technical drawing

| ARTICLE NO. | LAMP TYPE | BRAND | LIGHT OUTPUT | MODULE POWER | MODULE EFFICIENCY | CORRELATED COLOUR TEMPERATURE | COLOUR RENDERING INDEX | TC LIFE | mA | SALES PRICE |
|--------------|-----------|-----------|--------------|--------------|-------------------|-------------------------------|------------------------|---------|-----|-------------|
| Δ see colors | | | LM | W | LM/W | K | CRI | HRS | mA | EURO |
| 4005.990.28Δ | BXRA | Bridgelux | 600 | 6.6 | 86 | 3000 | >80 | 50.000 | 350 | € 75,00 |

TECHNICAL INFORMATION

PRODUCT

CAP R2



- PRODUCT MATERIAL** ▶ Die-cast aluminium
- LIGHT SOURCE** ▶ Bridgelux
- MODULE LIFETIME** ▶ Approx. 50.000 hours
- LED COOLING** ▶ Passive cooling
- DRIVER** ▶ Incl. driver + cable and plug standard
- COLORS (Δ)** ▶
 - 3 = RAL 9003 white
 - 5 = RAL 9005 black
 - 6 = RAL 9006 alu
- BEAM ANGLE** ▶ 2X 28°
- ADJUSTABLE** ▶ Yes
- SIZE** ▶ 208 X 105 X 70MM

OPTIONS

- GLASS COVER CLEAR** ▶ 2x Glass IP44 € 15,00
art. no.: 0053.999.99.0
- GLASS FILTER** ▶ 2x Filter 2600K glass € 60,00
art. no.: 4006.999.27.0
- DIMMABLE DRIVER** ▶ Lumotech 20W 1/10v 350mA € 23,50
art. no.: 0136.999.99.0
- IN COMBINATION WITH CAP R2**
 - OSRAM 18W Leading & trailing edge 350 mA € 23,50
art. no.: 0113.999.99.0

INFORMATION

WARRANTY ▶ 5 Years

Δ = product color code. See colors
This luminaire is "plug & play".
Incl. 2x 1.5m cable and plug.

Keylight International B.V. reserves the right to modify or change technical, construction or LED specifications due to continuous improvements of our products and lightsources.



CAP R2

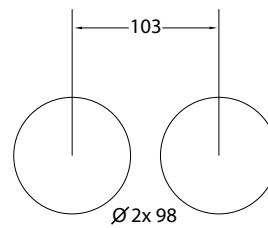

Hole size

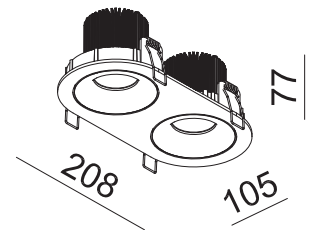

Technical drawing

| ARTICLE NO. | LAMP TYPE | BRAND | LIGHT OUTPUT | MODULE POWER | MODULE EFFICIENCY | CORRELATED COLOUR TEMPERATURE | COLOUR RENDERING INDEX | TC LIFE | mA | SALES PRICE |
|--------------|-----------|-----------|--------------|--------------|-------------------|-------------------------------|------------------------|---------|-----------|-------------|
| Δ see colors | | | LM | W | LM/W | K | CRI | HRS | mA | EURO |
| 4055.990.28Δ | BXRA | Bridgelux | 2X 600 | 2X 6.6 | 86 | 3000 | >80 | 50.000 | 2X 350 MA | € 145,00 |

TECHNICAL INFORMATION

PRODUCT

ALASKA



- ▶ **PRODUCT MATERIAL** Die-cast aluminium + alu
- ▶ **LIGHT SOURCE** LED DISK
- ▶ **MODULE LIFETIME** Approx. 50.000 hours
- ▶ **LED COOLING** Passive cooling
- ▶ **DRIVER** Incl. integrated driver
- ▶ **COLORS (Δ)** ● 3 = RAL 9003 white
- ▶ **BEAM ANGLE** 60°
- ▶ **ADJUSTABLE** No
- ▶ **SIZE** 106 X 120MM

OPTIONS

- ▶ **COLORS** White
- ▶ **DIMMABLE** Standard dimmable. Leading Edge

INFORMATION

- ▶ **WARRANTY** 5 Years

This luminaire is "plug & play".

Incl. 1.5m cable and plug.

Keylight International B.V. reserves the right to modify or change technical, construction or LED specifications due to continuous improvements of our products and lightsources.



ALASKA

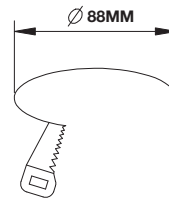

Hole size

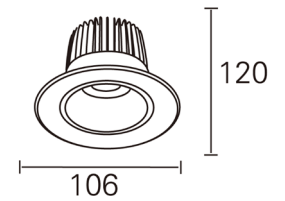

Technical drawing

| ARTICLE NO. | LAMP TYPE | BRAND | LIGHT OUTPUT | MODULE POWER | MODULE EFFICIENCY | CORRELATED COLOUR TEMPERATURE | COLOUR RENDERING INDEX | TC LIFE | POWER FACTOR | SALES PRICE |
|---------------|-----------|---------|--------------|--------------|-------------------|-------------------------------|------------------------|---------|--------------|-------------|
| Δ see colors | | | LM | W | LM/W | K | RA | HRS | PF | EURO |
| 4106.141.85.3 | Disk G3 | Philips | 800 | 12 | 68 | 2700 | >80 | 50.000 | >,09 | € 90,00 |
| 4106.142.85.3 | Disk G3 | Philips | 800 | 12 | 68 | 3000 | >80 | 50.000 | >,09 | € 90,00 |
| 4106.143.85.3 | Disk G3 | Philips | 850 | 11 | 72 | 4000 | >80 | 50.000 | >,09 | € 90,00 |

TECHNICAL INFORMATION

PRODUCT

URANUS 11



- PRODUCT MATERIAL** ▶ Aluminium
- LIGHT SOURCE** ▶ CXA LED
- DRIVER** ▶ Included
- COLORS** ▶
 - **WW** = RAL 9003 white reflector
 - **ALU** = RAL 9006 polished reflector
- BEAM ANGLE** ▶ 40°
- ADJUSTABLE** ▶ No
- SIZE** ▶ 108 X 120MM

OPTIONS

- REFLECTOR** ▶
 - A = Aluminium / glossy
 - W = White

INFORMATION

Including cable, plug, connection cable and driver.

Keylight International B.V. reserves the right to modify or change technical, construction or LED specifications due to continuous improvements of our products and lightsources.



URANUS

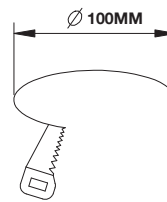

Hole size

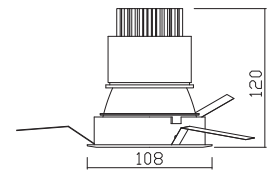

Technical drawing

| ARTICLE NO. | LAMP TYPE | BRAND | LIGHT OUTPUT | MODULE POWER | MODULE EFFICIENCY | CORRELATED COLOUR TEMPERATURE | COLOUR RENDERING INDEX | TC LIFE | REFL. | SALES PRICE |
|---------------|-----------|-------|--------------|--------------|-------------------|-------------------------------|------------------------|---------|--------|-------------|
| Δ see colors | | | LM | W | LM/W | K | RA | HRS | DEGREE | EURO |
| 4108.990.40.A | CXA LED | Cree | 680 | 7.4 | 74 | 2700 | 80 | 30.000 | 40° | € 90,00 |
| 4108.990.40.W | CXA LED | Cree | Cree | 7.4 | 74 | 2700 | 80 | 30.000 | 40° | € 90,00 |

TECHNICAL INFORMATION

PRODUCT

CIRC 10



- PRODUCT MATERIAL** ▶ Die-cast aluminium
- LIGHT SOURCE** ▶ MR16 LED / LMR50
- DRIVER** ▶ LMR 50 includes a driver
- COLORS** ▶
 - 3 = RAL 9003 white
 - 5 = RAL 9005 black
 - 6 = RAL 9006 alu
- BEAM ANGLE** ▶ LMR: 20° / 30°
- ADJUSTABLE** ▶ Yes
- SIZE** ▶ 106 X 110MM **OR INCL. LMR 106 X 80MM**

OPTIONS LMR

- DIMMABLE DRIVER IN COMBINATION WITH CIRC 10** ▶
 - OSRAM 8,5W 1/10v 350mA € 23,50
art. no.: 0110.999.99.0
 - OSRAM 13W phase-cut 350 mA € 23,50
art. no.: 0111.999.99.0
- OPTIONAL FRONT RING** ▶ LMR50 Aluminium colour. € 3,95
art. no.: 0052.999.99.6
- MOUNTING BRACKET** ▶ LMR50 incl. mounting set € 5,00
art. no.: 0051.999.99.5
- GLASS COVER CLEAR** ▶ LMR50 glass IP44 € 7,50
art. no.: 0053.999.99.0

INFORMATION

LMR including cable, plug, connection cable and driver.



Only luminaire body, lightsource and/or driver excluded.

Keylight International B.V. reserves the right to modify or change technical, construction or LED specifications due to continuous improvements of our products and lightsources.



CIRC 10

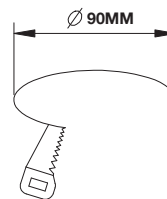

Hole size

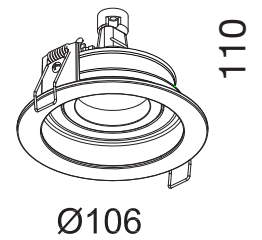

Technical drawing



LMR50

| ARTICLE NO. | LAMP TYPE | BRAND | LIGHT OUTPUT | MODULE POWER | MODULE EFFICIENCY | CORRELATED COLOUR TEMPERATURE | COLOUR RENDERING INDEX | TC LIFE | REFL. | mA | SALES PRICE |
|----------------|-----------|-----------|--------------|--------------|-------------------|-------------------------------|------------------------|---------|--------|-----|-------------|
| Δ see colors | | | LM | W | LM/W | K | RA | HRS | DEGREE | mA | EURO |
| ! 4098.989.98Δ | Gu5.3 | | | Max. 50W | | | | | | | € 23,50 |
| ! 4098.989.98Δ | Gu10 | | | Max. 50W | | | | | | | € 23,50 |
| 4098.171.20Δ | LMR50 | Bridgelux | 560 | 6.6 | 79 | 2700 | >80 | 25.000 | 20° | 350 | € 65,00 |
| 4098.172.30Δ | LMR50 | Bridgelux | 560 | 6.6 | 79 | 2700 | >80 | 25.000 | 30° | 350 | € 65,00 |
| 4098.173.20Δ | LMR50 | Bridgelux | 600 | 6.6 | 86 | 3000 | >80 | 25.000 | 20° | 350 | € 65,00 |
| 4098.174.30Δ | LMR50 | Bridgelux | 600 | 6.6 | 86 | 3000 | >80 | 25.000 | 30° | 350 | € 65,00 |

TECHNICAL INFORMATION

PRODUCT

CIRC 13



- PRODUCT MATERIAL** ▶ Die-cast aluminium
- LIGHT SOURCE** ▶ Ba15D / LMR70
- DRIVER** ▶ LMR 70 includes a driver
- COLORS** ▶
 - 3 = RAL 9003 white
 - 5 = RAL 9005 black
 - 6 = RAL 9006 alu
- BEAM ANGLE** ▶ LMR: 20° / 30°
- ADJUSTABLE** ▶ Yes
- SIZE** ▶ 130 X 60MM OR INCL. LMR 130 X 110MM

OPTIONS LMR

- DIMMABLE DRIVER** ▶
 - LMR70 8.5w Dim. 1/10v € 37,00
 - LMR70 10w Dim. phase-cut € 35,00
- OPTIONAL FRONT RING** ▶ LMR70 Aluminium colour. € 3,95
- MOUNTING BRACKET** ▶ LMR70 incl. mounting set € 5,00

INFORMATION

LMR including cable, plug, connection cable and driver.

! Only luminaire body, lightsource and/or driver excluded.

Keylight International B.V. reserves the right to modify or change technical, construction or LED specifications due to continuous improvements of our products and lightsources.



CIRC 13

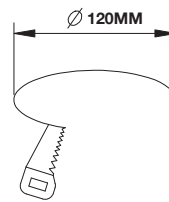

Hole size

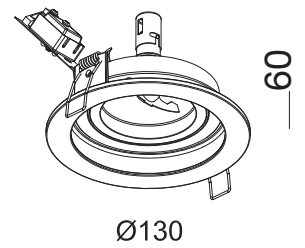

Technical drawing



LMR70

| ARTICLE NO. | LAMP TYPE | BRAND | LIGHT OUTPUT | MODULE POWER | MODULE EFFICIENCY | CORRELATED COLOUR TEMPERATURE | COLOUR RENDERING INDEX | TC LIFE | REFL. | mA | SALES PRICE |
|-----------------------|-----------|-----------|--------------|--------------|-------------------|-------------------------------|------------------------|---------|--------|-----|-------------|
| Δ see colors | | | LM | W | LM/W | K | RA | HRS | DEGREE | mA | EURO |
| ! 4099.999.98Δ | Ba15D | | | Max. 50W | | | | | | | € 35,00 |
| 4099.175.20Δ | LMR70 | Bridgelux | 1330 | 15 | 89 | 2700 | >80 | 25.000 | 20° | 700 | € 85,00 |
| 4099.176.30Δ | LMR70 | Bridgelux | 1330 | 15 | 89 | 2700 | >80 | 25.000 | 30° | 700 | € 85,00 |
| 4099.177.20Δ | LMR70 | Bridgelux | 1410 | 15 | 94 | 3000 | >80 | 25.000 | 20° | 700 | € 85,00 |
| 4099.178.30Δ | LMR70 | Bridgelux | 1410 | 15 | 94 | 3000 | >80 | 25.000 | 30° | 700 | € 85,00 |

TECHNICAL INFORMATION

PRODUCT

JIVE 13



- PRODUCT MATERIAL** ▶ Die-cast Aluminium
- LIGHT SOURCE** ▶ CXA 1512
- MODULE LIFETIME** ▶ Approx. 25.000 Hours
- LED COOLING** ▶ Passive cooling
- DRIVER** ▶ Philips
- COLORS** ▶ ● 3 = RAL 9003 white
- BEAM ANGLE** ▶ 120°
- REFLECTOR** ▶ Acrylic diffuser
- ADJUSTABLE** ▶ No
- SIZE** ▶ 115 X 66MM

INFORMATION

- WARRANTY** ▶ 2 Years.

This luminaire is "plug & play".

Incl. 1.5m cable and plug.

Keylight International B.V. reserves the right to modify or change technical, construction or LED specifications due to continuous improvements of our products and lightsources.

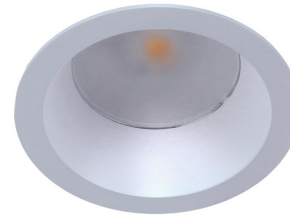

JIVE 13

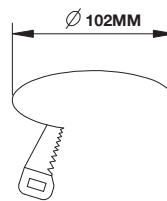

Hole size

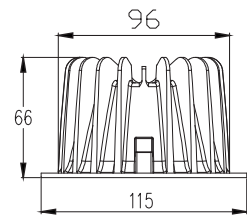

Technical drawing

| ARTICLE NO. | LAMP TYPE | BRAND | LIGHT OUTPUT | MODULE POWER | MODULE EFFICIENCY | CORRELATED COLOUR TEMPERATURE | COLOUR RENDERING INDEX | TC LIFE | mA | SALES PRICE |
|---------------|-----------|-------|--------------|--------------|-------------------|-------------------------------|------------------------|---------|-----|-------------|
| | | | LM | W | LM/W | K | RA | HRS | mA | EURO |
| 4111.999.20.3 | CXA 1512 | Cree | 1200 | 13 | 92 | 3000 | >80 | 25.000 | 350 | € 70,00 |

TECHNICAL INFORMATION

PRODUCT

JIVE 30



- PRODUCT MATERIAL** ▶ Die-cast Aluminium
- LIGHT SOURCE** ▶ Core AC 230v
- MODULE LIFETIME** ▶ Approx. 50.000 Hours
- LED COOLING** ▶ Passive cooling
- DRIVER** ▶ Integrated AC driver Included.
- COLORS** ▶ ● 3 = RAL 9003 white
- BEAM ANGLE** ▶ 120°
- REFLECTOR** ▶ Acrylic diffuser
- ADJUSTABLE** ▶ No
- SIZE** ▶ 176 X 108MM

INFORMATION

- WARRANTY** ▶ 2 Years.

This luminaire is "plug & play".

Incl. 2m cable and plug.

Not dimmable!

Flicker free

Keylight International B.V. reserves the right to modify or change technical, construction or LED specifications due to continuous improvements of our products and lightsources.



JIVE 30

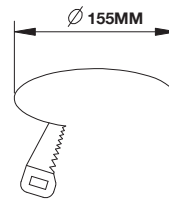

Hole size

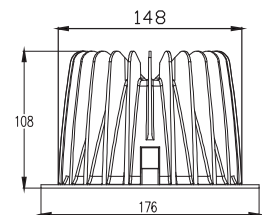

Technical drawing

| ARTICLE NO. | LAMP TYPE | BRAND | LIGHT OUTPUT | MODULE POWER | MODULE EFFICIENCY | CORRELATED COLOUR TEMPERATURE | COLOUR RENDERING INDEX | TC LIFE | SALES PRICE |
|---------------|-------------|-------|--------------|--------------|-------------------|-------------------------------|------------------------|---------|-------------|
| | | | LM | W | LM/W | K | RA | HRS | EURO |
| 4112.750.20.3 | Core AC Pro | Osram | 2000 | 20 | 100 | 3000 | >80 | 50.000 | € 110,00 |
| 4112.751.20.3 | Core AC Pro | Osram | 2000 | 20 | 103 | 4000 | >80 | 50.000 | € 110,00 |
| 4112.752.20.3 | Core AC Pro | Osram | 3000 | 33 | 90 | 3000 | >80 | 50.000 | € 115,00 |
| 4112.753.20.3 | Core AC Pro | Osram | 3000 | 33 | 93 | 4000 | >80 | 50.000 | € 115,00 |

TECHNICAL INFORMATION

PRODUCT

JIVE 44



- PRODUCT MATERIAL** ▶ Die-cast Aluminium
- LIGHT SOURCE** ▶ Core AC 230v
- MODULE LIFETIME** ▶ Approx. 50.000 Hours
- LED COOLING** ▶ Passive cooling
- DRIVER** ▶ Integrated AC driver Included.
- COLORS** ▶ ● 3 = RAL 9003 white
- BEAM ANGLE** ▶ 120°
- REFLECTOR** ▶ Acrylic diffuser
- ADJUSTABLE** ▶ No
- SIZE** ▶ 205 X 120MM

INFORMATION

- WARRANTY** ▶ 2 Years.

This luminaire is "plug & play".

Incl. 2m cable and plug.

Not dimmable!

Flicker free

Keylight International B.V. reserves the right to modify or change technical, construction or LED specifications due to continuous improvements of our products and lightsources.



JIVE 44

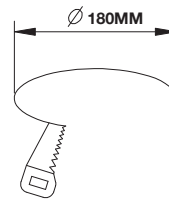

Hole size

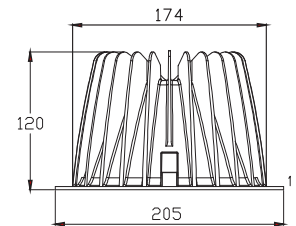

Technical drawing

| ARTICLE NO. | LAMP TYPE | BRAND | LIGHT OUTPUT | MODULE POWER | MODULE EFFICIENCY | CORRELATED COLOUR TEMPERATURE | COLOUR RENDERING INDEX | TC LIFE | SALES PRICE |
|---------------|-------------|-------|--------------|--------------|-------------------|-------------------------------|------------------------|---------|-------------|
| | | | LM | W | LM/W | K | RA | HRS | EURO |
| 4113.750.20.3 | Core AC Pro | Osram | 2000 | 20 | 100 | 3000 | >80 | 50.000 | € 110,00 |
| 4113.751.20.3 | Core AC Pro | Osram | 2000 | 20 | 103 | 4000 | >80 | 50.000 | € 110,00 |
| 4113.752.20.3 | Core AC Pro | Osram | 3000 | 33 | 90 | 3000 | >80 | 50.000 | € 115,00 |
| 4113.753.20.3 | Core AC Pro | Osram | 3000 | 33 | 93 | 4000 | >80 | 50.000 | € 115,00 |

TECHNICAL INFORMATION

PRODUCT

YORK 13



- PRODUCT MATERIAL** ▶ Steel + alu
- LIGHT SOURCE** ▶ SLM G4
- MODULE LIFETIME** ▶ Approx. 50.000 hours
- LED COOLING** ▶ Passive cooling
- DRIVER** ▶ Incl. Xitanium driver.
- COLORS (Δ)** ▶
 - 3 = RAL 9003 white
 - 5 = RAL 9005 black
 - 6 = RAL 9006 alu
- BEAM ANGLE** ▶ 30°
- ADJUSTABLE** ▶ No
- SIZE** ▶ 130 X 200MM

OPTIONS

- COLORS** ▶ Available in all RAL colours on request.
Additional price + 10%
- EMERGENCY BALLAST** ▶ 1 - 3 hours € 225,00
- DIMMABLE** ▶ Dimmable or daii. € 45,00
- GLASS & IP RING** ▶ Optional IP44 ring with clear
or mat glass. Price on request.

INFORMATION

- WARRANTY** ▶ 5 Years

Δ = product color code. See colors

Keylight International B.V. reserves the right to modify or change technical, construction or LED specifications due to continuous improvements of our products and lightsources.



YORK 13

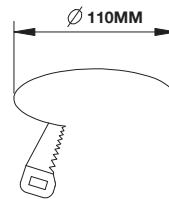

Hole size

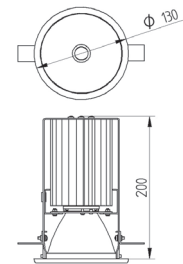

Technical drawing

| ARTICLE NO. | LAMP TYPE | BRAND | LIGHT OUTPUT | MODULE POWER | SETTING | MODULE EFFICIENCY | CORRELATED COLOUR TEMPERATURE | COLOUR RENDERING INDEX | B50/L70 AT TC LIFE | SALES PRICE |
|--------------|---------------------|---------|--------------|--------------|-----------------|-------------------|-------------------------------|------------------------|--------------------|-------------|
| Δ see colors | GEN 4 | | LM | W | | LM/W | K | RA | HRS | EURO |
| 4130.111.30Δ | SLM 1100-827 L13 # | Philips | 1160 | 10 | High Efficiency | 114 | 2700 | >82 | 50.000 | € 225,00 |
| 4130.112.30Δ | SLM 1100-830 L13 | Philips | 1240 | 10 | High Efficiency | 122 | 3000 | >82 | 50.000 | € 225,00 |
| 4130.113.30Δ | SLM 1100-840 L13 | Philips | 1330 | 10 | High Efficiency | 130 | 4000 | >82 | 50.000 | € 225,00 |
| 4130.114.30Δ | SLM 2000-830 L13 | Philips | 2020 | 17 | High Efficiency | 117 | 3000 | >82 | 50.000 | € 235,00 |
| 4130.116.30Δ | SLM 2000-840 L13 | Philips | 2150 | 17 | High Efficiency | 124 | 4000 | >82 | 50.000 | € 235,00 |
| 4130.125.30Δ | SLM 2000-927 L13 # | Philips | 1570 | 17 | High Efficiency | 91 | 2700 | >97 | 50.000 | € 235,00 |
| 4130.120.30Δ | SLM 2000-930 L13 | Philips | 1650 | 17 | High Efficiency | 95 | 3000 | >97 | 50.000 | € 245,00 |
| 4130.117.30Δ | SLM 3000-830 L15 | Philips | 2970 | 26 | High Efficiency | 114 | 3000 | >82 | 50.000 | € 245,00 |
| 4130.119.30Δ | SLM 3000-840 L15 | Philips | 3170 | 26 | High Efficiency | 122 | 4000 | >82 | 50.000 | € 245,00 |
| 4130.128.30Δ | SLM 3000-927 L15 # | Philips | 2320 | 26 | High Efficiency | 89 | 2700 | >97 | 50.000 | € 245,00 |
| 4130.121.30Δ | SLM 3000-930 L15 | Philips | 2400 | 26 | High Efficiency | 92 | 3000 | >97 | 50.000 | € 245,00 |
| 4130.109.30Δ | SLM CW 3000-930 L15 | Philips | 2790 | 34 | Crisp White | 82 | 3000 | >92 | 50.000 | € 245,00 |

* SLM G4: High efficacy is Keylight standard, High value: option for more Lumen flux output (more power, more watt) option on request.
 # SLM 827 + 927, On special request
 - SLM Premium White (colour point bBBL) 2000 Lm / 4500 Lm 3000k, On special request

TECHNICAL INFORMATION

PRODUCT

HELIX 14



- PRODUCT MATERIAL** ▶ Steel + aluminium
- LIGHT SOURCE** ▶ SLM G4
- MODULE LIFETIME** ▶ Approx. 50.000 hours
- LED COOLING** ▶ Fan cooling
- DRIVER** ▶ Incl. Xitanium driver.
- COLORS (Δ)** ▶
 - 3 = RAL 9003 white
 - 5 = RAL 9005 black
 - 6 = RAL 9006 alu
- BEAM ANGLE** ▶ 35°
- ADJUSTABLE** ▶ Yes
- SIZE** ▶ 142 X 117MM

OPTIONS

- COLORS** ▶ Available in all RAL colours on request.
Additional price + 10%
- EMERGENCY BALLAST** ▶ 1 - 3 hours. € 225,00
- DIMMABLE** ▶ Dimmable or dali on request € 45,00

INFORMATION

- WARRANTY** ▶ 5 Years

Δ = product color code. See colors

Keylight International B.V. reserves the right to modify or change technical, construction or LED specifications due to continuous improvements of our products and lightsources.



HELIX 14

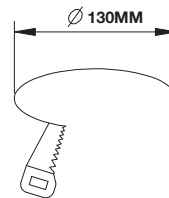

Hole size

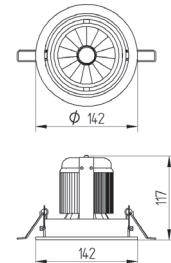

Technical drawing

| ARTICLE NO. | LAMP TYPE | BRAND | LIGHT OUTPUT | MODULE POWER | SETTING | MODULE EFFICIENCY | CORRELATED COLOUR TEMPERATURE | COLOUR RENDERING INDEX | B50/L70 AT TC LIFE | SALES PRICE |
|---------------|---------------------|---------|--------------|--------------|------------------|-------------------|-------------------------------|------------------------|--------------------|-------------|
| Δ see colors | GEN 4 | | LM | W | | LM/W | K | RA | HRS | EURO |
| 4142.111.30Δ | SLM 1100-827 L13 # | Philips | 1160 | 10 | High Efficiency | 114 | 2700 | >82 | 50.000 | € 225,00 |
| 4142.112.30Δ | SLM 1100-830 L13 | Philips | 1240 | 10 | High Efficiency | 122 | 3000 | >82 | 50.000 | € 225,00 |
| 4142.113.30Δ | SLM 1100-840 L13 | Philips | 1330 | 10 | High Efficiency | 130 | 4000 | >82 | 50.000 | € 225,00 |
| 4142.114.30Δ | SLM 2000-830 L13 | Philips | 2020 | 17 | High Efficiency | 117 | 3000 | >82 | 50.000 | € 235,00 |
| 4142.116.30Δ | SLM 2000-840 L13 | Philips | 2150 | 17 | High Efficiency | 124 | 4000 | >82 | 50.000 | € 235,00 |
| 4142.125.30Δ | SLM 2000-927 L13 # | Philips | 1570 | 17 | High Efficiency | 91 | 2700 | >97 | 50.000 | € 235,00 |
| 4142.120.30Δ | SLM 2000-930 L13 | Philips | 1650 | 17 | High Efficiency | 95 | 3000 | >97 | 50.000 | € 235,00 |
| 4142.117.30Δ | SLM 3000-830 L15 | Philips | 2970 | 26 | High Efficiency | 114 | 3000 | >82 | 50.000 | € 245,00 |
| 4142.119.30Δ | SLM 3000-840 L15 | Philips | 3170 | 26 | High Efficiency | 122 | 4000 | >82 | 50.000 | € 245,00 |
| 4142.128.30Δ | SLM 3000-927 L15 # | Philips | 2320 | 26 | High Efficiency | 89 | 2700 | >97 | 50.000 | € 245,00 |
| 4142.121.30Δ | SLM 3000-930 L15 | Philips | 2400 | 26 | High Efficiency | 92 | 3000 | >97 | 50.000 | € 245,00 |
| 4142.135.24.Δ | SLM 4500-830 L19 | Philips | 4860 | 42 | High Efficiency | 114 | 3000 | >82 | 50.000 | € 270,00 |
| 4142.136.24.Δ | SLM 4500-840 L19 | Philips | 5160 | 42 | High Efficiency | 122 | 4000 | >82 | 50.000 | € 270,00 |
| 4142.157.24.Δ | SLM 4500-927 L19 | Philips | 3760 | 42 | High Efficiency | 89 | 2700 | >97 | 50.000 | € 275,00 |
| 4142.137.24.Δ | SLM 4500-930 L19 | Philips | 3930 | 42 | High Efficiency | 92 | 3000 | >97 | 50.000 | € 275,00 |
| 4142.109.24.Δ | SLM CW 3000-930 L15 | Philips | 2790 | 34 | Crisp White | 82 | 3000 | >92 | 50.000 | € 265,00 |
| 4142.110.24.Δ | SLM CW 3800-930 L19 | Philips | 2790 | 34 | Crisp White | 82 | 3000 | >92 | 50.000 | € 295,00 |
| 4142.159.24.Δ | SLM FW 2800-925 L19 | Philips | 2880 | 42 | Food Warm White | 69 | 2900 | >90 | 50.000 | € 310,00 |
| 4142.160.24.Δ | SLM FR 3000-930 L19 | Philips | 2980 | 42 | Food Premium red | 72 | 3150 | >87 | 50.000 | € 310,00 |

* SLM G4: High efficacy is Keylight standard, High value: option for more Lumen flux output (more power, more watt) option on request.
 # SLM 827 + 927, On special request
 - SLM Premium White (colour point bBBL) 2000 Lm / 4500 Lm 3000k, On special request

TECHNICAL INFORMATION

PRODUCT

MONACO 15



- PRODUCT MATERIAL** ▶ Aluminium
- LIGHT SOURCE** ▶ Philips DLM-S
- MODULE LIFETIME** ▶ Approx. 30.000 hours
- LED COOLING** ▶ Passive cooling
- DRIVER** ▶ Incl. Intergrated Driver
- COLORS** ▶ ● 3 = RAL 9003 white
- BEAM ANGLE** ▶ 80°
- REFLECTOR** ▶ White
- ADJUSTABLE** ▶ No
- SIZE** ▶ 142 X 89MM

OPTIONS

- REFLECTOR** ▶
 - 4071= White reflector (Standard)
 - 4072= Glossy reflector € 85,00
 - 4073= IP44 Ring + glass € 99,00

INFORMATION

- WARRANTY** ▶ 2 Years

This luminaire is "plug & play".

Incl. 2m cable and plug.

Keylight International B.V. reserves the right to modify or change technical, construction or LED specifications due to continuous improvements of our products and lightsources.



MONACO 15. ALSO AVAILABLE WITH IP44 COVER (SEE PICTURE ABOVE)

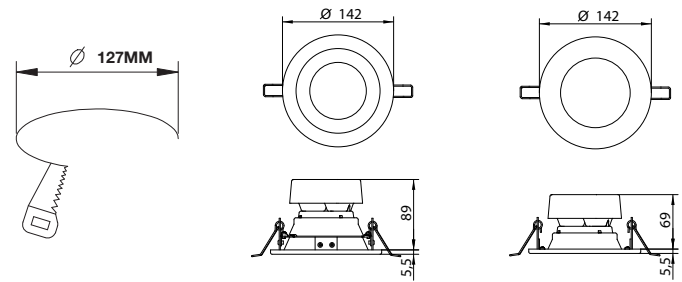

Hole size

Technical drawing RW

Technical drawing IP

| ARTICLE NO. | LAMP TYPE | BRAND | LIGHT OUTPUT | MODULE POWER | MODULE EFFICIENCY | CORRELATED COLOUR TEMPERATURE | COLOUR RENDERING INDEX | TC LIFE | POWER FACTOR | SALES PRICE |
|---------------|-----------|---------|--------------|--------------|-------------------|-------------------------------|------------------------|---------|--------------|-------------|
| | | | LM | W | LM/W | K | RA | HRS | PF | EURO |
| 4071.138.80.3 | DLM-S | Philips | 1000 | 13 | 70 | 3000 | >80 | 30.000 | >09, | € 85,00 |
| 4071.139.80.3 | DLM-S | Philips | 1000 | 13 | 70 | 4000 | >80 | 30.000 | >09, | € 85,00 |

TECHNICAL INFORMATION

PRODUCT

MONACO 20



- PRODUCT MATERIAL** ▶ Aluminium
- LIGHT SOURCE** ▶ Philips DLM-S
- MODULE LIFETIME** ▶ Approx. 30.000 hours
- LED COOLING** ▶ Passive cooling
- DRIVER** ▶ Incl. Intergrated Driver
- COLORS** ▶ ● 3 = RAL 9003 white
- BEAM ANGLE** ▶ 80°
- REFLECTOR** ▶ White
- ADJUSTABLE** ▶ No
- SIZE** ▶ 215 X 102MM

OPTIONS

- !** **REFLECTOR** ▶
 - 4076= White reflector
 - 4077= Glossy reflector € 110,00
 - 4078= IP44 Ring + glass € 120,00

INFORMATION

- WARRANTY** ▶ 2 Years

This luminaire is "plug & play".

Incl. 2m cable and plug.

Keylight International B.V. reserves the right to modify or change technical, construction or LED specifications due to continuous improvements of our products and lightsources.



MONACO 20. ALSO AVAILABLE WITH IP44 COVER (SEE PICTURE ABOVE)

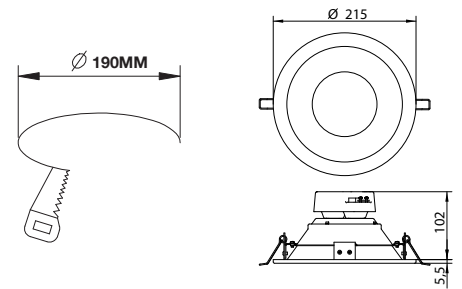

Hole size

Technical drawing RW

| ARTICLE NO. | LAMP TYPE | BRAND | LIGHT OUTPUT | MODULE POWER | MODULE EFFICIENCY | CORRELATED COLOUR TEMPERATURE | COLOUR RENDERING INDEX | TC LIFE | POWER FACTOR | SALES PRICE |
|---------------|-----------|---------|--------------|--------------|-------------------|-------------------------------|------------------------|---------|--------------|-------------|
| | | | LM | W | LM/W | K | RA | HRS | PF | EURO |
| 4076.130.80.3 | DLM-S | Philips | 2000 | 26 | 70 | 3000 | >80 | 30.000 | >09, | € 110,00 |
| 4076.140.80.3 | DLM-S | Philips | 2000 | 26 | 70 | 4000 | >80 | 30.000 | >09, | € 110,00 |

TECHNICAL INFORMATION

PRODUCT

VISION 15



- PRODUCT MATERIAL** ▶ Die-cast aluminium
- LIGHT SOURCE** ▶ SLM G4
- MODULE LIFETIME** ▶ Approx. 50.000 hours
- LED COOLING** ▶ Passive cooling
- DRIVER** ▶ Incl. Xitanium driver.
- COLORS (Δ)** ▶
 - 3 = RAL 9003 white
 - 5 = RAL 9005 black
 - 6 = RAL 9006 alu
- BEAM ANGLE** ▶ 24°
- ADJUSTABLE** ▶ Yes
- SIZE** ▶ 146 X 141MM

OPTIONS

- EMERGENCY BALLAST** ▶ 0187.999.99 1 - 3 hours. € 275,00
- DIFFUSER** ▶ 0186.999.99 (frosted diffuser) € 9,50
- DIFFUSER W/ HOLE** ▶ 0188.999.99 (frosted diffuser) € 9,50
- DIMMABLE** ▶ Dimmable DALI € 45,00

INFORMATION

- WARRANTY** ▶ 5 Years

Δ = product color code. See colors

Keylight International B.V. reserves the right to modify or change technical, construction or LED specifications due to continuous improvements of our products and lightsources.



VISION 15

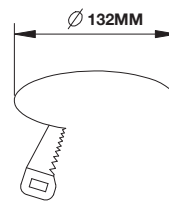

Hole size

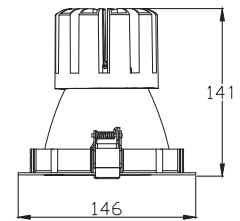

Technical drawing

| ARTICLE NO. | LAMP TYPE | BRAND | LIGHT OUTPUT | MODULE POWER | SETTING | MODULE EFFICIENCY | CORRELATED COLOUR TEMPERATURE | COLOUR RENDERING INDEX | B50/L70 AT TC LIFE | SALES PRICE |
|--------------|---------------------|---------|--------------|--------------|-----------------|-------------------|-------------------------------|------------------------|--------------------|-------------|
| Δ see colors | GEN 4 | | LM | W | | LM/W | K | RA | HRS | EURO |
| 4021.111.30Δ | SLM 1100-827 L13 # | Philips | 1160 | 10 | High Efficiency | 114 | 2700 | >82 | 50.000 | € 150,00 |
| 4021.112.30Δ | SLM 1100-830 L13 | Philips | 1240 | 10 | High Efficiency | 122 | 3000 | >82 | 50.000 | € 150,00 |
| 4021.113.30Δ | SLM 1100-840 L13 | Philips | 1330 | 10 | High Efficiency | 130 | 4000 | >82 | 50.000 | € 150,00 |
| 4021.114.30Δ | SLM 2000-830 L13 | Philips | 2020 | 17 | High Efficiency | 117 | 3000 | >82 | 50.000 | € 160,00 |
| 4021.116.30Δ | SLM 2000-840 L13 | Philips | 2150 | 17 | High Efficiency | 124 | 4000 | >82 | 50.000 | € 160,00 |
| 4021.125.30Δ | SLM 2000-927 L13 # | Philips | 1570 | 17 | High Efficiency | 91 | 2700 | >97 | 50.000 | € 165,00 |
| 4021.120.30Δ | SLM 2000-930 L13 | Philips | 1650 | 17 | High Efficiency | 95 | 3000 | >97 | 50.000 | € 165,00 |
| 4021.117.30Δ | SLM 3000-830 L15 | Philips | 2970 | 26 | High Efficiency | 114 | 3000 | >82 | 50.000 | € 170,00 |
| 4021.119.30Δ | SLM 3000-840 L15 | Philips | 3170 | 26 | High Efficiency | 122 | 4000 | >82 | 50.000 | € 170,00 |
| 4021.128.30Δ | SLM 3000-927 L15 # | Philips | 2320 | 26 | High Efficiency | 89 | 2700 | >97 | 50.000 | € 175,00 |
| 4021.121.30Δ | SLM 3000-930 L15 | Philips | 2400 | 26 | High Efficiency | 92 | 3000 | >97 | 50.000 | € 175,00 |
| 4021.109.30Δ | SLM CW 3000-930 L15 | Philips | 2790 | 34 | Crisp White | 82 | 3000 | >92 | 50.000 | € 195,00 |

* SLM G4: High efficacy is Keylight standard, High value: option for more Lumen flux output (more power, more watt) option on request.
 # SLM 827 + 927, On special request
 - SLM Premium White (colour point bBBL) 2000 Lm / 4500 Lm 3000k, On special request

TECHNICAL INFORMATION

PRODUCT

VISION 20



- PRODUCT MATERIAL ▶ Die-cast aluminium
- LIGHT SOURCE ▶ SLM G4
- MODULE LIFETIME ▶ Approx. 50.000 hours
- LED COOLING ▶ Passive cooling
- DRIVER ▶ Incl. Xitanium driver.
- COLORS (Δ) ▶
 - 3 = RAL 9003 white
 - 5 = RAL 9005 black
 - 6 = RAL 9006 alu
- BEAM ANGLE ▶ 24°
- ADJUSTABLE ▶ Yes
- SIZE ▶ 197 X 166 XMM

OPTIONS

- EMERGENCY BALLAST ▶ 0187.999.99 1 - 3 hours. € 275,00
- DIFFUSER ▶ 0183.999.99 (frosted diffuser) € 9,50
- DIFFUSER W/ HOLE ▶ 0189.999.99 (frosted diffuser) € 9,50
- DIMMABLE ▶ Dimmable DALI € 45,00

INFORMATION

- WARRANTY ▶ 5 Years

Δ = product color code. See colors



VISION 20

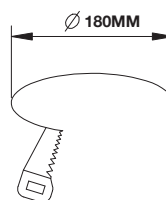

Hole size

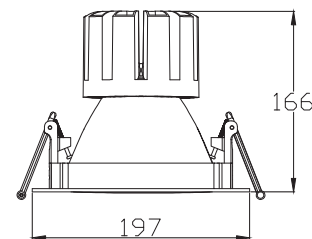

Technical drawing

| ARTICLE NO. | LAMP TYPE | BRAND | LIGHT OUTPUT | MODULE POWER | SETTING | MODULE EFFICIENCY | CORRELATED COLOUR TEMPERATURE | COLOUR RENDERING INDEX | B50/L70 AT TC LIFE | SALES PRICE |
|---------------|---------------------|---------|--------------|--------------|------------------|-------------------|-------------------------------|------------------------|--------------------|-------------|
| Δ see colors | GEN 4 | | LM | W | | LM/W | K | RA | HRS | EURO |
| 4023.111.30Δ | SLM 1100-827 L13 # | Philips | 1160 | 10 | High Efficiency | 114 | 2700 | >82 | 50.000 | € 165,00 |
| 4023.112.30Δ | SLM 1100-830 L13 | Philips | 1240 | 10 | High Efficiency | 122 | 3000 | >82 | 50.000 | € 165,00 |
| 4023.113.30Δ | SLM 1100-840 L13 | Philips | 1330 | 10 | High Efficiency | 130 | 4000 | >82 | 50.000 | € 165,00 |
| 4023.114.30Δ | SLM 2000-830 L13 | Philips | 2020 | 17 | High Efficiency | 117 | 3000 | >82 | 50.000 | € 175,00 |
| 4023.116.30Δ | SLM 2000-840 L13 | Philips | 2150 | 17 | High Efficiency | 124 | 4000 | >82 | 50.000 | € 175,00 |
| 4023.125.30Δ | SLM 2000-927 L13 # | Philips | 1570 | 17 | High Efficiency | 91 | 2700 | >97 | 50.000 | € 180,00 |
| 4023.120.30Δ | SLM 2000-930 L13 | Philips | 1650 | 17 | High Efficiency | 95 | 3000 | >97 | 50.000 | € 180,00 |
| 4023.117.30Δ | SLM 3000-830 L15 | Philips | 2970 | 26 | High Efficiency | 114 | 3000 | >82 | 50.000 | € 185,00 |
| 4023.119.30Δ | SLM 3000-840 L15 | Philips | 3170 | 26 | High Efficiency | 122 | 4000 | >82 | 50.000 | € 185,00 |
| 4023.128.30Δ | SLM 3000-927 L15 # | Philips | 2320 | 26 | High Efficiency | 89 | 2700 | >97 | 50.000 | € 190,00 |
| 4023.121.30Δ | SLM 3000-930 L15 | Philips | 2400 | 26 | High Efficiency | 92 | 3000 | >97 | 50.000 | € 190,00 |
| 4024.135.24.Δ | SLM 4500-830 L19 | Philips | 4860 | 42 | High Efficiency | 114 | 3000 | >82 | 50.000 | € 225,00 |
| 4024.136.24.Δ | SLM 4500-840 L19 | Philips | 5160 | 42 | High Efficiency | 122 | 4000 | >82 | 50.000 | € 225,00 |
| 4024.157.24.Δ | SLM 4500-927 L19 | Philips | 3760 | 42 | High Efficiency | 89 | 2700 | >97 | 50.000 | € 230,00 |
| 4024.137.24.Δ | SLM 4500-930 L19 | Philips | 3930 | 42 | High Efficiency | 92 | 3000 | >97 | 50.000 | € 230,00 |
| 4024.109.24.Δ | SLM CW 3000-930 L15 | Philips | 2790 | 34 | Crisp White | 82 | 3000 | >92 | 50.000 | € 210,00 |
| 4024.110.24.Δ | SLM CW 3800-930 L19 | Philips | 2790 | 34 | Crisp White | 82 | 3000 | >92 | 50.000 | € 250,00 |
| 4024.159.24.Δ | SLM FW 2800-925 L19 | Philips | 2880 | 42 | Food Warm White | 69 | 2900 | >90 | 50.000 | € 265,00 |
| 4024.160.24.Δ | SLM FR 3000-930 L19 | Philips | 2980 | 42 | Food Premium red | 72 | 3150 | >87 | 50.000 | € 265,00 |

* SLM G4: High efficacy is Keylight standard, High value: option for more Lumen flux output (more power, more watt) option on request.
 # SLM 827 + 927, On special request
 - SLM Premium White (colour point bBBL) 2000 Lm / 4500 Lm 3000k, On special request

TECHNICAL INFORMATION

PRODUCT

NOVA



- PRODUCT MATERIAL** ▶ Die-cast aluminium + aluminium
- LIGHT SOURCE** ▶ SLM G4
- MODULE LIFETIME** ▶ Approx. 50.000 hours
- LED COOLING** ▶ Passive cooling
- DRIVER** ▶ Incl. Xitanium driver.
- COLORS (Δ)** ▶
 - 3 = RAL 9003 white
 - 5 = RAL 9005 black
 - 6 = RAL 9006 alu
- BEAM ANGLE** ▶ 24°
- ADJUSTABLE** ▶ Yes
- SIZE** ▶ 156 X 224MM

OPTIONS

- EMERGENCY BALLAST** ▶ 0187.999.99 1 - 3 hours. € 275,00
- OPTIONAL BEAM ANGLE** ▶ 16° / 36° € 5,00
- DIFFUSER** ▶ 0180.999.99 (frosted diffuser) € 9,50
- DIFFUSER W/ HOLE** ▶ 0185.999.99 (frosted diffuser) € 9,50
- DIMMABLE** ▶ Dimmable DALI € 40,00

INFORMATION

- WARRANTY** ▶ 5 Years

Δ = product color code. See colors



NOVA

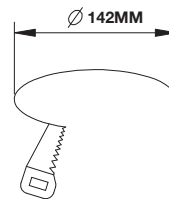

Hole size

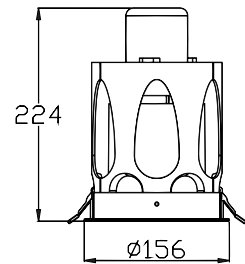

Technical drawing

Keylight International B.V. reserves the right to modify or change technical, construction or LED specifications due to continuous improvements of our products and lightsources.

| ARTICLE NO. | LAMP TYPE | BRAND | LIGHT OUTPUT | MODULE POWER | SETTING | MODULE EFFICIENCY | CORRELATED COLOUR TEMPERATURE | COLOUR RENDERING INDEX | B50/L70 AT TC LIFE | SALES PRICE |
|--------------|---------------------|---------|--------------|--------------|-----------------|-------------------|-------------------------------|------------------------|--------------------|-------------|
| Δ see colors | GEN 4 | | LM | W | | LM/W | K | RA | HRS | EURO |
| 4026.111.30Δ | SLM 1100-827 L13 # | Philips | 1160 | 10 | High Efficiency | 114 | 2700 | >82 | 50.000 | € 165,00 |
| 4026.112.30Δ | SLM 1100-830 L13 | Philips | 1240 | 10 | High Efficiency | 122 | 3000 | >82 | 50.000 | € 165,00 |
| 4026.113.30Δ | SLM 1100-840 L13 | Philips | 1330 | 10 | High Efficiency | 130 | 4000 | >82 | 50.000 | € 165,00 |
| 4026.114.30Δ | SLM 2000-830 L13 | Philips | 2020 | 17 | High Efficiency | 117 | 3000 | >82 | 50.000 | € 175,00 |
| 4026.116.30Δ | SLM 2000-840 L13 | Philips | 2150 | 17 | High Efficiency | 124 | 4000 | >82 | 50.000 | € 175,00 |
| 4026.125.30Δ | SLM 2000-927 L13 # | Philips | 1570 | 17 | High Efficiency | 91 | 2700 | >97 | 50.000 | € 180,00 |
| 4026.120.30Δ | SLM 2000-930 L13 | Philips | 1650 | 17 | High Efficiency | 95 | 3000 | >97 | 50.000 | € 180,00 |
| 4026.117.30Δ | SLM 3000-830 L15 | Philips | 2970 | 26 | High Efficiency | 114 | 3000 | >82 | 50.000 | € 185,00 |
| 4026.119.30Δ | SLM 3000-840 L15 | Philips | 3170 | 26 | High Efficiency | 122 | 4000 | >82 | 50.000 | € 185,00 |
| 4026.128.30Δ | SLM 3000-927 L15 # | Philips | 2320 | 26 | High Efficiency | 89 | 2700 | >97 | 50.000 | € 190,00 |
| 4026.121.30Δ | SLM 3000-930 L15 | Philips | 2400 | 26 | High Efficiency | 92 | 3000 | >97 | 50.000 | € 190,00 |
| 4026.109.30Δ | SLM CW 3000-930 L15 | Philips | 2790 | 34 | Crisp White | 82 | 3000 | >92 | 50.000 | € 210,00 |

* SLM G4: High efficacy is Keylight standard, High value: option for more Lumen flux output (more power, more watt) option on request.
 # SLM 827 + 927, On special request
 - SLM Premium White (colour point bBBL) 2000 Lm / 4500 Lm 3000k, On special request

TECHNICAL INFORMATION

PRODUCT

ROLED 17



- PRODUCT MATERIAL** ▶ Die-cast aluminium
- LIGHT SOURCE** ▶ SLM G4
- MODULE LIFETIME** ▶ Approx. 50.000 hours
- LED COOLING** ▶ Passive cooling
- DRIVER** ▶ Incl. Xitanium driver.
- COLORS (Δ)** ▶
 - 3 = RAL 9003 white
 - 5 = RAL 9005 black
 - 6 = RAL 9006 alu
- BEAM ANGLE** ▶ 24°
- ADJUSTABLE** ▶ Yes
- SIZE** ▶ 169 X 118MM

OPTIONS

- EMERGENCY BALLAST** ▶ 0187.999.99 1 - 3 hours. € 275,00
- OPTIONAL BEAM ANGLE** ▶ 16° or 36° € -
- DIFFUSER** ▶ 0180.999.99 (frosted diffuser) € 9,50
- DIFFUSER W/ HOLE** ▶ 0185.999.99 (frosted diffuser) € 9,50
- DIMMABLE** ▶ Dimmable DALI € 45,00

INFORMATION

- WARRANTY** ▶ 5 Years

Δ = product color code. See colors

Keylight International B.V. reserves the right to modify or change technical, construction or LED specifications due to continuous improvements of our products and lightsources.



ROLED 17

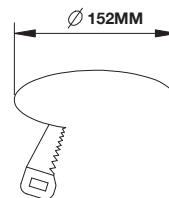

Hole size

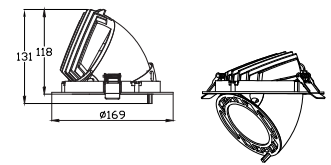

Technical drawing

| ARTICLE NO. | LAMP TYPE | BRAND | LIGHT OUTPUT | MODULE POWER | SETTING | MODULE EFFICIENCY | CORRELATED COLOUR TEMPERATURE | COLOUR RENDERING INDEX | B50/L70 AT TC LIFE | SALES PRICE |
|---------------|---------------------|---------|--------------|--------------|------------------|-------------------|-------------------------------|------------------------|--------------------|-------------|
| Δ see colors | GEN 4 | | LM | W | | LM/W | K | RA | HRS | EURO |
| 4024.111.30Δ | SLM 1100-827 L13 # | Philips | 1160 | 10 | High Efficiency | 114 | 2700 | >82 | 50.000 | € 150,00 |
| 4024.112.30Δ | SLM 1100-830 L13 | Philips | 1240 | 10 | High Efficiency | 122 | 3000 | >82 | 50.000 | € 150,00 |
| 4024.113.30Δ | SLM 1100-840 L13 | Philips | 1330 | 10 | High Efficiency | 130 | 4000 | >82 | 50.000 | € 150,00 |
| 4024.114.30Δ | SLM 2000-830 L13 | Philips | 2020 | 17 | High Efficiency | 117 | 3000 | >82 | 50.000 | € 160,00 |
| 4024.116.30Δ | SLM 2000-840 L13 | Philips | 2150 | 17 | High Efficiency | 124 | 4000 | >82 | 50.000 | € 160,00 |
| 4024.125.30Δ | SLM 2000-927 L13 # | Philips | 1570 | 17 | High Efficiency | 91 | 2700 | >97 | 50.000 | € 165,00 |
| 4024.120.30Δ | SLM 2000-930 L13 | Philips | 1650 | 17 | High Efficiency | 95 | 3000 | >97 | 50.000 | € 165,00 |
| 4024.117.30Δ | SLM 3000-830 L15 | Philips | 2970 | 26 | High Efficiency | 114 | 3000 | >82 | 50.000 | € 170,00 |
| 4024.119.30Δ | SLM 3000-840 L15 | Philips | 3170 | 26 | High Efficiency | 122 | 4000 | >82 | 50.000 | € 170,00 |
| 4024.128.30Δ | SLM 3000-927 L15 # | Philips | 2320 | 26 | High Efficiency | 89 | 2700 | >97 | 50.000 | € 175,00 |
| 4024.121.30Δ | SLM 3000-930 L15 | Philips | 2400 | 26 | High Efficiency | 92 | 3000 | >97 | 50.000 | € 175,00 |
| 4024.135.24.Δ | SLM 4500-830 L19 | Philips | 4860 | 42 | High Efficiency | 114 | 3000 | >82 | 50.000 | € 210,00 |
| 4024.136.24.Δ | SLM 4500-840 L19 | Philips | 5160 | 42 | High Efficiency | 122 | 4000 | >82 | 50.000 | € 210,00 |
| 4024.157.24.Δ | SLM 4500-927 L19 | Philips | 3760 | 42 | High Efficiency | 89 | 2700 | >97 | 50.000 | € 215,00 |
| 4024.137.24.Δ | SLM 4500-930 L19 | Philips | 3930 | 42 | High Efficiency | 92 | 3000 | >97 | 50.000 | € 215,00 |
| 4024.109.24.Δ | SLM CW 3000-930 L15 | Philips | 2790 | 34 | Crisp White | 82 | 3000 | >92 | 50.000 | € 195,00 |
| 4024.110.24.Δ | SLM CW 3800-930 L19 | Philips | 2790 | 34 | Crisp White | 82 | 3000 | >92 | 50.000 | € 235,00 |
| 4024.159.24.Δ | SLM FW 2800-925 L19 | Philips | 2880 | 42 | Food Warm White | 69 | 2900 | >90 | 50.000 | € 245,00 |
| 4024.160.24.Δ | SLM FR 3000-930 L19 | Philips | 2980 | 42 | Food Premium red | 72 | 3150 | >87 | 50.000 | € 245,00 |

* SLM G4: High efficacy is Keylight standard. High value: option for more Lumen flux output (more power, more watt) option on request.
 # SLM 827 + 927. On special request
 - SLM Premium White (colour point bBBL) 2000 Lm / 4500 Lm 3000k , On special request

TECHNICAL INFORMATION

PRODUCT

PLUTO 18



- PRODUCT MATERIAL** ▶ Die-cast aluminium
- LIGHT SOURCE** ▶ DLM G5 / DLM-I
- MODULE LIFETIME** ▶ DLM-I Approx. 25.000 hours
DLM Approx. 50.000 hours
- LED COOLING** ▶ Passive cooling
- DRIVER DLM-I** ▶ Incl. 230V intergrated driver.
- DRIVER DLM** ▶ Incl. standard xitanium driver.
- COLORS (Δ)** ▶ ● 3 = RAL 9003 white
● 5 = RAL 9005 black
- BEAM ANGLE** ▶ 60°
- ADJUSTABLE** ▶ No
- SIZE** ▶ 170 X 161MM

OPTIONS

- EMERGENCY BALLAST** ▶ DLM: 0187.999.99 1 - 3 hours € 275,00
- DIMMABLE** ▶ DLM: Dimmable DALI € 45,00

INFORMATION

- WARRANTY** ▶ 5 Years.

Δ = product color code. See colors

Incl. 1.5m cable and plug.

Keylight International B.V. reserves the right to modify or change technical, construction or LED specifications due to continuous improvements of our products and lightsources.



PLUTO 18

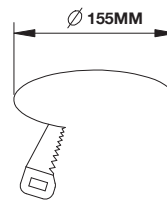

Hole size

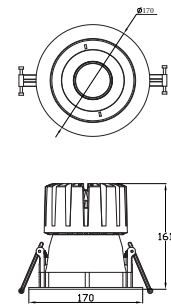

Technical drawing

| ARTICLE NO. | LAMP TYPE | BRAND | LIGHT OUTPUT | MODULE POWER | MODULE EFFICIENCY | CORRELATED COLOUR TEMPERATURE | COLOUR RENDERING INDEX | TC LIFE | POWER FACTOR | SALES PRICE |
|--------------|---------------|---------|--------------|--------------|-------------------|-------------------------------|------------------------|---------|--------------|-------------|
| Δ see colors | | | LM | W | LM/W | K | RA | HRS | PF | EURO |
| 4163.122.60Δ | DLM-Int | Philips | 1100 | 15 | 73 | 3000 | >80 | 25.000 | >,09 | € 150,00 |
| 4163.123.60Δ | DLM-Int | Philips | 1100 | 14 | 79 | 4000 | >80 | 25.000 | >,09 | € 150,00 |
| 4163.124.70Δ | DLM-Int | Philips | 2000 | 28 | 71 | 3000 | >80 | 25.000 | >,09 | € 160,00 |
| 4163.125.70Δ | DLM-Int | Philips | 2000 | 27 | 74 | 4000 | >80 | 25.000 | >,09 | € 160,00 |
| 4163.101.60Δ | DLM FLEX 1100 | Philips | 1279 | 10.1 | 128 | 3000 | >80 | 60.000 | >,09 | € 170,00 |
| 4163.102.60Δ | DLM FLEX 1100 | Philips | 1279 | 9.1 | 141 | 4000 | >80 | 60.000 | >,09 | € 170,00 |
| 4063.103.60Δ | DLM FLEX 2000 | Philips | 2326 | 18.1 | 129 | 3000 | >80 | 60.000 | >,09 | € 180,00 |
| 4163.104.60Δ | DLM FLEX 2000 | Philips | 2326 | 16.5 | 141 | 4000 | >80 | 60.000 | >,09 | € 180,00 |

TECHNICAL INFORMATION

PRODUCT

PLUTO 20



- PRODUCT MATERIAL** ▶ Die-cast aluminium
- LIGHT SOURCE** ▶ DLM-I / DLM G5
- MODULE LIFETIME** ▶ DLM-I Approx. 25.000 hours
DLM Approx. 50.000 hours
- LED COOLING** ▶ Passive cooling
- DRIVER DLM-I** ▶ Incl. 230V intergrated driver.
- DRIVER DLM** ▶ Incl. standard xitanium driver.
- COLORS (Δ)** ▶ ● 3 = RAL 9003 white
● 5 = RAL 9005 black
- BEAM ANGLE** ▶ 60°
- ADJUSTABLE** ▶ No
- SIZE** ▶ 197 X 165MM

OPTIONS

- EMERGENCY BALLAST** ▶ DLM: 0187.999.99 1 - 3 hours € 275,00
- DIMMABLE** ▶ DLM: Dimmable DALI € 45,00

INFORMATION

- WARRANTY** ▶ 5 Years.

Δ = product color code. See colors

Incl. 1.5m cable and plug.

Keylight International B.V. reserves the right to modify or change technical, construction or LED specifications due to continuous improvements of our products and lightsources.



PLUTO 20

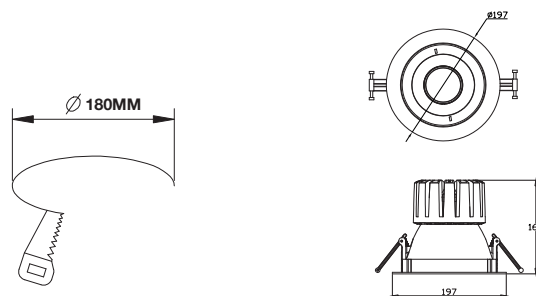

Hole size

Technical drawing

| ARTICLE NO. | LAMP TYPE | BRAND | LIGHT OUTPUT | MODULE POWER | MODULE EFFICIENCY | CORRELATED COLOUR TEMPERATURE | COLOUR RENDERING INDEX | TC LIFE | POWER FACTOR | SALES PRICE |
|--------------|---------------|---------|--------------|--------------|-------------------|-------------------------------|------------------------|---------|--------------|-------------|
| Δ see colors | | | LM | W | LM/W | K | RA | HRS | PF | EURO |
| 4175.122.60Δ | DLM-Int | Philips | 1100 | 15 | 73 | 3000 | >80 | 25.000 | >,09 | € 160,00 |
| 4175.123.60Δ | DLM-Int | Philips | 1100 | 14 | 79 | 4000 | >80 | 25.000 | >,09 | € 160,00 |
| 4175.124.60Δ | DLM-Int | Philips | 2000 | 28 | 71 | 3000 | >80 | 25.000 | >,09 | € 170,00 |
| 4175.125.60Δ | DLM-Int | Philips | 2000 | 27 | 74 | 4000 | >80 | 25.000 | >,09 | € 170,00 |
| 4175.101.60Δ | DLM FLEX 1100 | Philips | 1279 | 10.1 | 128 | 3000 | >80 | 60.000 | >,09 | € 180,00 |
| 4175.102.60Δ | DLM FLEX 1100 | Philips | 1279 | 9.1 | 141 | 4000 | >80 | 60.000 | >,09 | € 180,00 |
| 4175.103.60Δ | DLM FLEX 2000 | Philips | 2326 | 18.1 | 129 | 3000 | >80 | 60.000 | >,09 | € 190,00 |
| 4175.104.60Δ | DLM FLEX 2000 | Philips | 2326 | 16.5 | 141 | 4000 | >80 | 60.000 | >,09 | € 190,00 |
| 4175.105.60Δ | DLM FLEX 3000 | Philips | 3488 | 27 | 129 | 3000 | >80 | 60.000 | >,09 | € 210,00 |
| 4175.106.60Δ | DLM FLEX 3000 | Philips | 3488 | 24.7 | 141 | 4000 | >80 | 60.000 | >,09 | € 210,00 |

TECHNICAL INFORMATION

PRODUCT

STAR 18



- PRODUCT MATERIAL** ▶ Die-cast aluminium
- LIGHT SOURCE** ▶ LED
- MODULE LIFETIME** ▶ Approx. 35.000 hours
- LED COOLING** ▶ Passive cooling
- DRIVER** ▶ Incl. driver.
- COLORS (Δ)** ▶
 - 3 = RAL 9003 white
 - 5 = RAL 9005 black
 - 6 = RAL 9006 alu
- BEAM ANGLE** ▶ 120°
- ADJUSTABLE** ▶ No
- SIZE** ▶ 178 X 17MM

OPTIONS

- COLORS** ▶ White

INFORMATION

Δ = product color code. See colors

Keylight International B.V. reserves the right to modify or change technical, construction or LED specifications due to continuous improvements of our products and lightsources.



STAR 18

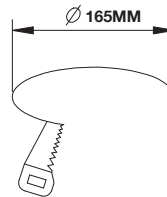

Hole size

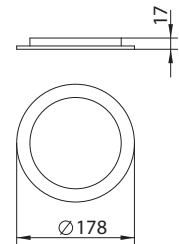

Technical drawing

| ARTICLE NO. | LAMP TYPE | BRAND | LIGHT OUTPUT | MODULE POWER | MODULE EFFICIENCY | CORRELATED COLOUR TEMPERATURE | COLOUR RENDERING INDEX | TC LIFE | POWER FACTOR | SALES PRICE |
|----------------|-----------|-------|--------------|--------------|-------------------|-------------------------------|------------------------|---------|--------------|-------------|
| Δ see colors | | | LM | W | LM/W | K | RA | HRS | PF | EURO |
| 4178.910.91.3Δ | LED | TW | 800 | 13 | 60 | 3000 | >80 | 35.000 | >09, | € 140,00 |

TECHNICAL INFORMATION

PRODUCT

STAR 28



- ▶ **PRODUCT MATERIAL** Die-cast aluminium
- ▶ **LIGHT SOURCE** LED
- ▶ **MODULE LIFETIME** Approx. 30.000 hours
- ▶ **LED COOLING** Passive cooling
- ▶ **DRIVER** Incl. driver.
- ▶ **COLORS (Δ)**
 - 3 = RAL 9003 white
 - 5 = RAL 9005 black
 - 6 = RAL 9006 alu
- ▶ **BEAM ANGLE** 120°
- ▶ **ADJUSTABLE** No
- ▶ **SIZE** 237 X 17MM

OPTIONS

- ▶ **COLORS** White

INFORMATION

Δ = product color code. See colors

Keylight International B.V. reserves the right to modify or change technical, construction or LED specifications due to continuous improvements of our products and lightsources.



STAR 28

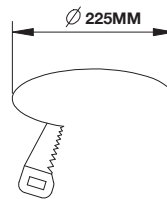

Hole size

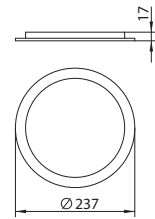

Technical drawing

| ARTICLE NO. | LAMP TYPE | BRAND | LIGHT OUTPUT | MODULE POWER | MODULE EFFICIENCY | CORRELATED COLOUR TEMPERATURE | COLOUR RENDERING INDEX | TC LIFE | POWER FACTOR | SALES PRICE |
|----------------|-----------|-------|--------------|--------------|-------------------|-------------------------------|------------------------|---------|--------------|-------------|
| Δ see colors | | | LM | W | LM/W | K | RA | HRS | PF | EURO |
| 4237.910.91.3Δ | LED | TW | 1500 | 20 | 75 | 3000 | >80 | 30.000 | >09, | € 175,00 |

TECHNICAL INFORMATION

PRODUCT

JUPITER 17



- ▶ **PRODUCT MATERIAL** Aluminium
- ▶ **LIGHT SOURCE** XB-D LED
- ▶ **MODULE LIFETIME** Approx. 30.000 hours
- ▶ **LED COOLING** Passive cooling
- ▶ **DRIVER** Including driver.
- ▶ **COLORS** ● 3 = RAL 9003 white
- ▶ **BEAM ANGLE** Opal plate
- ▶ **ADJUSTABLE** No
- ▶ **SIZE** 172 X 105MM

INFORMATION

Incl. 1.5m cable and plug.

Keylight International B.V. reserves the right to modify or change technical, construction or LED specifications due to continuous improvements of our products and lightsources.



JUPITER

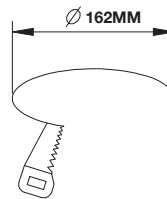

Hole size

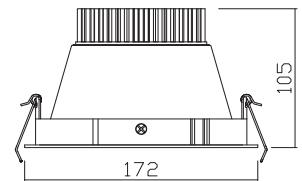

Technical drawing

| ARTICLE NO. | LAMP TYPE | BRAND | LIGHT OUTPUT | MODULE POWER | MODULE EFFICIENCY | CORRELATED COLOUR TEMPERATURE | COLOUR RENDERING INDEX | TC LIFE | SALES PRICE |
|---------------|-----------|-------|--------------|--------------|-------------------|-------------------------------|------------------------|---------|-------------|
| | | | LM | W | LM/W | K | RA | HRS | EURO |
| 4017.990.80.3 | XB-D LED | Cree | 1450 | 24 | 61 | 2700 | >80 | 30.000 | € 160,00 |

TECHNICAL INFORMATION

PRODUCT

MOON 17



- ▶ **PRODUCT MATERIAL** Aluminium & ABS plastics
- ▶ **LIGHT SOURCE** Disk G3
- ▶ **MODULE LIFETIME** Approx. 50.000 hours
- ▶ **LED COOLING** Passive cooling
- ▶ **DRIVER** Incl. integrated driver.
- ▶ **COLORS** ● 3 = RAL 9003 white
- ▶ **BEAM ANGLE** 55°
- ▶ **ADJUSTABLE** No
- ▶ **SIZE** 171 X 119MM

OPTIONS

- ▶ **DIMMABLE** Standard dimmable leading edge.

INFORMATION

- ▶ **WARRANTY DISK** 5 Years.

Incl. 1.5m cable and plug.

Keylight International B.V. reserves the right to modify or change technical, construction or LED specifications due to continuous improvements of our products and lightsources.



MOON 17

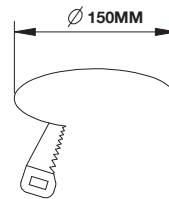

Hole size

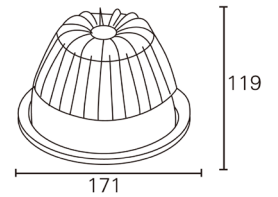

Technical drawing

| ARTICLE NO. | LAMP TYPE | BRAND | LIGHT OUTPUT | MODULE POWER | MODULE EFFICIENCY | CORRELATED COLOUR TEMPERATURE | COLOUR RENDERING INDEX | TC LIFE | POWER FACTOR | SALES PRICE |
|---------------|-----------|---------|--------------|--------------|-------------------|-------------------------------|------------------------|---------|--------------|-------------|
| | | | LM | W | LM/W | K | RA | HRS | PF | EURO |
| 4017.141.85.3 | Disk G3 | Philips | 800 | 12 | 68 | 2700 | >80 | 50.000 | >,09 | € 99,00 |
| 4017.142.85.3 | Disk G3 | Philips | 800 | 12 | 68 | 3000 | >80 | 50.000 | >,09 | € 99,00 |
| 4017.143.85.3 | Disk G3 | Philips | 850 | 11 | 72 | 4000 | >80 | 50.000 | >,09 | € 99,00 |

TECHNICAL INFORMATION

PRODUCT

MOON 22



- PRODUCT MATERIAL** ▶ Aluminium & ABS plastics
- LIGHT SOURCE** ▶ DLM-I / DLM G5
- MODULE LIFETIME** ▶ DLM-I Approx. 25.000 hours
DLM Approx. 50.000 hours
- LED COOLING** ▶ Passive cooling
- DRIVER DLM-I** ▶ Incl. 230V integrated driver.
- DRIVER DLM** ▶ Incl. standard xitanium driver.
- COLORS** ▶ ● 3 = RAL 9003 white
- BEAM ANGLE** ▶ 55°
- ADJUSTABLE** ▶ No
- SIZE** ▶ 219 X 135MM

OPTIONS

- DIMMABLE** ▶ DLM: Dimmable DALI € 45,00
- EMERGENCY BALLAST** ▶ DLM: 0187.999.99 1 - 3 hours € 275,00

INFORMATION

- WARRANTY** ▶ 5 Years

Incl. 1.5m cable and plug.

Keylight International B.V. reserves the right to modify or change technical, construction or LED specifications due to continuous improvements of our products and lightsources.



MOON 22

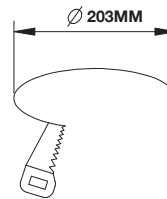

Hole size

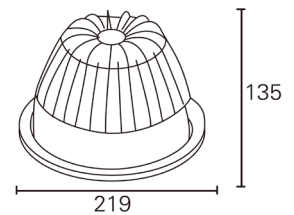

Technical drawing

| ARTICLE NO. | LAMP TYPE | BRAND | LIGHT OUTPUT | | MODULE EFFICIENCY | | CORRELATED COLOUR TEMPERATURE | COLOUR RENDERING INDEX | TC LIFE | POWER FACTOR | SALES PRICE |
|---------------|---------------|---------|--------------|------|-------------------|------|-------------------------------|------------------------|---------|--------------|-------------|
| | | | LM | W | LM/W | K | | | | | |
| 4020.122.55.3 | DLM-Int | Philips | 1100 | 15 | 73 | 3000 | >80 | 25.000 | >,09 | € 120,00 | |
| 4020.123.55.3 | DLM-Int | Philips | 1100 | 14 | 79 | 4000 | >80 | 25.000 | >,09 | € 120,00 | |
| 4020.124.55.3 | DLM-Int | Philips | 2000 | 28 | 71 | 3000 | >80 | 25.000 | >,09 | € 125,00 | |
| 4020.125.55.3 | DLM-Int | Philips | 2000 | 27 | 74 | 4000 | >80 | 25.000 | >,09 | € 125,00 | |
| 4020.101.55.3 | DLM FLEX 1100 | Philips | 1279 | 10.1 | 128 | 3000 | >80 | 60.000 | >,09 | € 130,00 | |
| 4020.102.55.3 | DLM FLEX 1100 | Philips | 1279 | 9.1 | 141 | 4000 | >80 | 60.000 | >,09 | € 130,00 | |
| 4020.103.55.3 | DLM FLEX 2000 | Philips | 2326 | 18.1 | 129 | 3000 | >80 | 60.000 | >,09 | € 140,00 | |
| 4020.104.55.3 | DLM FLEX 2000 | Philips | 2326 | 16.5 | 141 | 4000 | >80 | 60.000 | >,09 | € 140,00 | |
| 4020.105.55.3 | DLM FLEX 3000 | Philips | 3488 | 27 | 129 | 3000 | >80 | 60.000 | >,09 | € 165,00 | |
| 4020.106.55.3 | DLM FLEX 3000 | Philips | 3488 | 24.7 | 141 | 4000 | >80 | 60.000 | >,09 | € 165,00 | |

TECHNICAL INFORMATION

PRODUCT

MOON 27



- PRODUCT MATERIAL** ▶ Aluminium & ABS plastics
- LIGHT SOURCE** ▶ DLM-I / DLM G5
- MODULE LIFETIME** ▶ DLM-I Approx. 25.000 hours
DLM Approx. 50.000 hours
- LED COOLING** ▶ Passive cooling
- DRIVER DLM-I** ▶ Incl. 230V intergrated driver.
- DRIVER DLM** ▶ Incl. standard xitanium driver.
- COLORS** ▶ ● 3 = RAL 9003 white
- BEAM ANGLE** ▶ 70°
- ADJUSTABLE** ▶ No
- SIZE** ▶ 270 X 178MM

OPTIONS

- DIMMABLE** ▶ Dimmable DALI € 45,00
- EMERGENCY BALLAST** ▶ DLM: 0187.999.99 1 - 3 hours € 275,00

INFORMATION

- WARRANTY** ▶ 5 Years

Incl. 1.5m cable and plug.

Keylight International B.V. reserves the right to modify or change technical, construction or LED specifications due to continuous improvements of our products and lightsources.



MOON 27

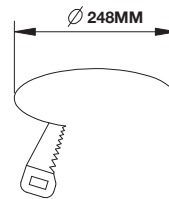

Hole size

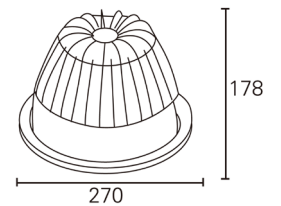

Technical drawing

| ARTICLE NO. | LAMP TYPE | BRAND | LIGHT OUTPUT | MODULE POWER | MODULE EFFICIENCY | CORRELATED COLOUR TEMPERATURE | COLOUR RENDERING INDEX | TC LIFE | POWER FACTOR | SALES PRICE |
|---------------|---------------|---------|--------------|--------------|-------------------|-------------------------------|------------------------|---------|--------------|-------------|
| | | | | | | | | | | |
| 4027.122.55.3 | DLM-Int | Philips | 1100 | 15 | 73 | 3000 | >80 | 25.000 | >,09 | € 130,00 |
| 4027.123.55.3 | DLM-Int | Philips | 1100 | 14 | 79 | 4000 | >80 | 25.000 | >,09 | € 130,00 |
| 4027.124.55.3 | DLM-Int | Philips | 2000 | 28 | 71 | 3000 | >80 | 25.000 | >,09 | € 135,00 |
| 4027.125.55.3 | DLM-Int | Philips | 2000 | 27 | 74 | 4000 | >80 | 25.000 | >,09 | € 135,00 |
| 4027.101.55.3 | DLM FLEX 1100 | Philips | 1279 | 10.1 | 128 | 3000 | >80 | 60.000 | >,09 | € 140,00 |
| 4027.102.55.3 | DLM FLEX 1100 | Philips | 1279 | 9.1 | 141 | 4000 | >80 | 60.000 | >,09 | € 140,00 |
| 4027.103.55.3 | DLM FLEX 2000 | Philips | 2326 | 18.1 | 129 | 3000 | >80 | 60.000 | >,09 | € 150,00 |
| 4027.104.55.3 | DLM FLEX 2000 | Philips | 2326 | 16.5 | 141 | 4000 | >80 | 60.000 | >,09 | € 150,00 |
| 4027.105.55.3 | DLM FLEX 3000 | Philips | 3488 | 27 | 129 | 3000 | >80 | 60.000 | >,09 | € 175,00 |
| 4027.106.55.3 | DLM FLEX 3000 | Philips | 3488 | 24.7 | 141 | 4000 | >80 | 60.000 | >,09 | € 175,00 |

TECHNICAL INFORMATION

PRODUCT

NOX 18 R



- PRODUCT MATERIAL** ▶ Steel and Alu
- LIGHT SOURCE** ▶ DLM-I / DLM G5 / DLM-Lixel
- MODULE LIFETIME** ▶ DLM-I Approx. 25.000 hours
DLM Approx. 50.000 hours
- LED COOLING** ▶ Passive cooling
- DRIVER DLM-I** ▶ Incl. 230V intergrated driver.
- DRIVER DLM** ▶ Incl. standard xitanium driver.
- COLORS** ▶ 3 = RAL 9003 white
 5 = RAL 9005 black
 6 = RAL 9006 alu
- BEAM ANGLE** ▶ 80°
- ADJUSTABLE** ▶ No
- SIZE** ▶ 189 X 175MM

OPTIONS

- COLORS** ▶ Available in all RAL colours on request
Additional price + 10%
- EMERGENCY BALLAST** ▶ DLM: 0187.999.99 1 - 3 hours € 275,00
- DIMMABLE** ▶ DLM: Dimmable or dali € 45,00
- GLASS & IP RING** ▶ Optional IP44 ring with clear or mat glass
Price on request.

INFORMATION

- WARRANTY** ▶ 5 Years

Δ see colors
Lightsource Philips Lixel LED module, standard DMX controlled touch-dali ballast. Create various lighting atmospheres with selection of white and colored shapes

Keylight International B.V. reserves the right to modify or change technical, construction or LED specifications due to continuous improvements of our products and lightsources.



NOX 18 R

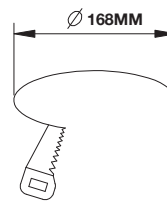

Hole size

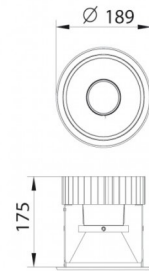

Technical drawing

| ARTICLE NO. | LAMP TYPE | BRAND | LIGHT OUTPUT | MODULE POWER | MODULE EFFICIENCY | CORRELATED COLOUR TEMPERATURE | COLOUR RENDERING INDEX | TC LIFE | POWER FACTOR | SALES PRICE |
|--------------|-----------|---------|--------------|--------------|-------------------|-------------------------------|------------------------|---------|--------------|-------------|
| Δ see colors | | | LM | W | LM/W | K | RA | HRS | PF | EURO |
| 4185.122.60Δ | DLM-Int | Philips | 1100 | 15 | 73 | 3000 | >80 | 25.000 | >,09 | € 165,00 |
| 4185.123.60Δ | DLM-Int | Philips | 1100 | 14 | 79 | 4000 | >80 | 25.000 | >,09 | € 165,00 |
| 4185.124.60Δ | DLM-Int | Philips | 2000 | 28 | 71 | 3000 | >80 | 25.000 | >,09 | € 175,00 |
| 4185.125.60Δ | DLM-Int | Philips | 2000 | 27 | 74 | 4000 | >80 | 25.000 | >,09 | € 175,00 |
| 4185.101.80Δ | DLM G5 | Philips | 1100 | 11 | 100 | 3000 | >80 | 50.000 | >,09 | € 220,00 |
| 4185.102.80Δ | DLM G5 | Philips | 1100 | 10 | 110 | 4000 | >80 | 50.000 | >,09 | € 220,00 |
| 4185.103.80Δ | DLM G5 | Philips | 2000 | 21 | 95 | 3000 | >80 | 50.000 | >,09 | € 235,00 |
| 4185.104.80Δ | DLM G5 | Philips | 2000 | 19 | 105 | 3000 | >80 | 50.000 | >,09 | € 235,00 |
| 4185.105.80Δ | DLM G5 | Philips | 3000 | 32 | 94 | 3000 | >80 | 50.000 | >,09 | € 245,00 |
| 4185.106.80Δ | DLM G5 | Philips | 3000 | 29 | 103 | 4000 | >80 | 50.000 | >,09 | € 245,00 |
| 4185.126.80Δ | DLM Lixel | Philips | 1000 | 24 | 42 | 2700-6500 | >80 | 50.000 | >,09 | € 580,00 |
| 4185.127.80Δ | DLM Lixel | Philips | 2000 | 40 | 48 | 2700-6500 | >80 | 50.000 | >,09 | € 580,00 |

TECHNICAL INFORMATION

PRODUCT

UTAH 18



- PRODUCT MATERIAL** ▶ Steel + alu
- LIGHT SOURCE** ▶ Twistable G3
- MODULE LIFETIME** ▶ Approx. 50.000 hours
- LED COOLING** ▶ Passive cooling
- DRIVER** ▶ Incl. Integrated driver.
- COLORS (Δ)** ▶
 - 3 = RAL 9003 white
 - 5 = RAL 9005 black
 - 6 = RAL 9006 alu
- BEAM ANGLE** ▶ 80°
- ADJUSTABLE** ▶ No
- SIZE** ▶ 189 X 169MM

OPTIONS

- COLORS** ▶ Available in all RAL colours on request.
Additional price + 10%
- DIMMABLE** ▶ Dimmable leading edge
- GLASS & IP RING** ▶ Optional IP44 ring with clear or mat glass
Price on request.

INFORMATION

- WARRANTY** ▶ 5 Years

Δ = product color code. See colors

Keylight International B.V. reserves the right to modify or change technical, construction or LED specifications due to continuous improvements of our products and lightsources.



UTAH 18

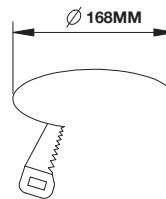

Hole size

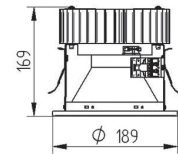

Technical drawing

| ARTICLE NO. | LAMP TYPE | BRAND | LIGHT OUTPUT | MODULE POWER | MODULE EFFICIENCY | CORRELATED COLOUR TEMPERATURE | COLOUR RENDERING INDEX | TC LIFE | POWER FACTOR | SALES PRICE |
|--------------|--------------|---------|--------------|--------------|-------------------|-------------------------------|------------------------|---------|--------------|-------------|
| Δ see colors | | | LM | W | LM/W | K | RA | HRS | PF | EURO |
| 4189.148.80Δ | Twistable G3 | Philips | 2000 | 30 | 70 | 3000 | >80 | 50.000 | >,09 | € 180,00 |
| 4189.149.80Δ | Twistable G3 | Philips | 2000 | 28 | 77 | 4000 | >80 | 50.000 | >,09 | € 180,00 |

TECHNICAL INFORMATION

PRODUCT

NOX 20 R



- PRODUCT MATERIAL** ▶ Steel and Alu
- LIGHT SOURCE** ▶ DLM-I / DLM G5 / DLM-Lexel
- MODULE LIFETIME** ▶ DLM-I Approx. 25.000 hours
DLM Approx. 50.000 hours
- LED COOLING** ▶ Passive cooling
- DRIVER DLM-I** ▶ Incl. 230V intergrated driver.
- DRIVER DLM** ▶ Incl. standard xitanium driver.
- COLORS** ▶ 3 = RAL 9003 white
 5 = RAL 9005 black
 6 = RAL 9006 alu
- BEAM ANGLE** ▶ 80°
- ADJUSTABLE** ▶ No
- SIZE** ▶ 220 X 185MM

OPTIONS

- COLORS** ▶ Available in all RAL colours on request
Additional price + 10%
- EMERGENCY BALLAST** ▶ DLM: IMP 1 - 3 hours € 225,00
- DIMMABLE** ▶ DLM: Dimmable or dali € 45,00
- GLASS & IP RING** ▶ Optional IP44 ring with clear or mat glass
Price on request.

INFORMATION

- WARRANTY** ▶ 5 Years

Δ see colors

Keylight International B.V. reserves the right to modify or change technical, construction or LED specifications due to continuous improvements of our products and lightsources.



NOX 20 R

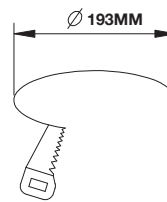

Hole size

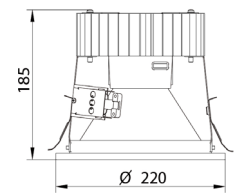

Technical drawing

| ARTICLE NO. | LAMP TYPE | BRAND | LIGHT OUTPUT | MODULE POWER | MODULE EFFICIENCY | CORRELATED COLOUR TEMPERATURE | COLOUR RENDERING INDEX | TC LIFE | POWER FACTOR | SALES PRICE |
|--------------|-----------|---------|--------------|--------------|-------------------|-------------------------------|------------------------|---------|--------------|-------------|
| Δ see colors | | | LM | W | LM/W | K | RA | HRS | PF | EURO |
| 4220.122.60Δ | DLM-Int | Philips | 1100 | 15 | 73 | 3000 | >80 | 25.000 | >,09 | € 170,00 |
| 4220.123.60Δ | DLM-Int | Philips | 1100 | 14 | 79 | 4000 | >80 | 25.000 | >,09 | € 170,00 |
| 4220.124.60Δ | DLM-Int | Philips | 2000 | 28 | 71 | 3000 | >80 | 25.000 | >,09 | € 180,00 |
| 4220.125.60Δ | DLM-Int | Philips | 2000 | 27 | 74 | 4000 | >80 | 25.000 | >,09 | € 180,00 |
| 4220.101.80Δ | DLM G5 | Philips | 1100 | 11 | 100 | 3000 | >80 | 50.000 | >,09 | € 225,00 |
| 4220.102.80Δ | DLM G5 | Philips | 1100 | 10 | 110 | 4000 | >80 | 50.000 | >,09 | € 225,00 |
| 4220.103.80Δ | DLM G5 | Philips | 2000 | 21 | 95 | 3000 | >80 | 50.000 | >,09 | € 240,00 |
| 4220.104.80Δ | DLM G5 | Philips | 2000 | 19 | 105 | 3000 | >80 | 50.000 | >,09 | € 240,00 |
| 4220.105.80Δ | DLM G5 | Philips | 3000 | 32 | 94 | 3000 | >80 | 50.000 | >,09 | € 250,00 |
| 4220.106.80Δ | DLM G5 | Philips | 3000 | 29 | 103 | 4000 | >80 | 50.000 | >,09 | € 250,00 |
| 4185.126.80Δ | DLM Lexel | Philips | 1000 | 24 | 42 | 2700-6500 | >80 | 50.000 | >,09 | € 545,00 |
| 4185.127.80Δ | DLM Lexel | Philips | 2000 | 40 | 48 | 2700-6500 | >80 | 50.000 | >,09 | € 585,00 |

TECHNICAL INFORMATION

PRODUCT

SOLAR 18



- PRODUCT MATERIAL** ▶ Steel & aluminium
- LIGHT SOURCE** ▶ Prevaled Cube
- MODULE LIFETIME** ▶ approx. 50.000 hours
- LED COOLING** ▶ Passive cooling
- DRIVER** ▶ Incl. 230v Osram AC driver
- COLORS (Δ)** ▶
 - 3 = RAL 9003 white
 - 5 = RAL 9005 black
 - 6 = RAL 9006 alu
- BEAM ANGLE** ▶ 80°
- ADJUSTABLE** ▶ No
- SIZE** ▶ 189 X 128MM

OPTIONS

- DIMMABLE** ▶ Dali € 45,00
- COLORS** ▶ Available in all RAL colours on request.
Additional price + 10%

INFORMATION

WARRANTY ▶ 5 Years

Δ = product color code. See colors

Optional IP44 ring with clear or mat glass on request.

Incl. 1.5m cable and plug.

Keylight International B.V. reserves the right to modify or change technical, construction or LED specifications due to continuous improvements of our products and lightsources.



SOLAR 18

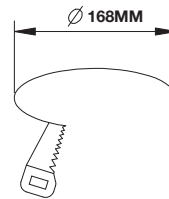

Hole size

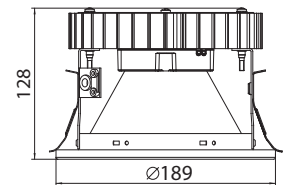

Technical drawing

| ARTICLE NO. | LAMP TYPE | BRAND | LIGHT OUTPUT | MODULE POWER | MODULE EFFICIENCY | CORRELATED COLOUR TEMPERATURE | COLOUR RENDERING INDEX | TC LIFE | SALES PRICE |
|----------------|-------------|-------|--------------|--------------|-------------------|-------------------------------|------------------------|---------|----------------------|
| Δ see colors | | | LM | W | LM/W | K | RA | HRS | EURO |
| 4418.122.55.3Δ | PREVALED AC | Osram | 1100 | 14 | 73 | 3000 | >80 | 50.000 | INT. DRIVER € 160,00 |
| 4418.123.55.3Δ | PREVALED AC | Osram | 1100 | 13 | 79 | 4000 | >80 | 50.000 | INT. DRIVER € 160,00 |
| 4418.124.55.3Δ | PREVALED AC | Osram | 2000 | 28 | 71 | 3000 | >80 | 50.000 | INT. DRIVER € 170,00 |
| 4418.125.55.3Δ | PREVALED AC | Osram | 2000 | 26 | 74 | 4000 | >80 | 50.000 | INT. DRIVER € 170,00 |
| 4418.101.55.3Δ | PREVALED AC | Osram | 3000 | 43 | 100 | 3000 | >80 | 50.000 | INT. DRIVER € 185,00 |
| 4418.102.55.3Δ | PREVALED AC | Osram | 3000 | 39 | 110 | 4000 | >80 | 50.000 | INT. DRIVER € 185,00 |
| 4418.101.55.3Δ | PREVALED | Osram | 1100 | 12 | 91 | 3000 | >80 | 50.000 | DRIVER € 170,00 |
| 4418.102.55.3Δ | PREVALED | Osram | 1100 | 12 | 91 | 4000 | >80 | 50.000 | DRIVER € 170,00 |
| 4418.103.55.3Δ | PREVALED | Osram | 2000 | 20 | 100 | 3000 | >80 | 50.000 | DRIVER € 185,00 |
| 4418.104.55.3Δ | PREVALED | Osram | 2000 | 20 | 100 | 4000 | >80 | 50.000 | DRIVER € 185,00 |
| 4418.105.55.3Δ | PREVALED | Osram | 3000 | 30 | 100 | 3000 | >80 | 50.000 | DRIVER € 200,00 |
| 4418.106.55.3Δ | PREVALED | Osram | 3000 | 30 | 100 | 4000 | >80 | 50.000 | DRIVER € 200,00 |

TECHNICAL INFORMATION

PRODUCT

SOLAR 22



- PRODUCT MATERIAL** ▶ Steel & aluminium
- LIGHT SOURCE** ▶ Prevaled Cube
- MODULE LIFETIME** ▶ approx. 50.000 hours
- LED COOLING** ▶ Passive cooling
- DRIVER** ▶ Incl. integrated AC Osram driver.
- COLORS (Δ)** ▶
 - 3 = RAL 9003 white
 - 5 = RAL 9005 black
 - 6 = RAL 9006 alu
- BEAM ANGLE** ▶ 80°
- ADJUSTABLE** ▶ No
- SIZE** ▶ 220 X 151MM

OPTIONS

- DIMMABLE** ▶ Dali € 45,00
- COLORS** ▶ Available in all RAL colours on request.
Additional price + 10%

INFORMATION

- WARRANTY** ▶ 5 Years

Δ = product color code. See colors.

Optional IP44 ring with clear or mat glass on request.

Incl. 1.5m cable and plug.

Keylight International B.V. reserves the right to modify or change technical, construction or LED specifications due to continuous improvements of our products and lightsources.



SOLAR 22

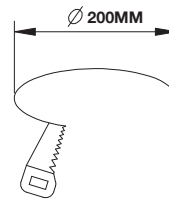

Hole size

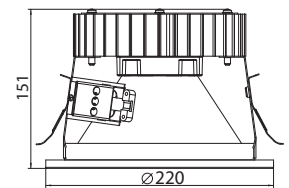

Technical drawing

| ARTICLE NO. | LAMP TYPE | BRAND | LIGHT OUTPUT | MODULE POWER | MODULE EFFICIENCY | CORRELATED COLOUR TEMPERATURE | COLOUR RENDERING INDEX | TC LIFE | SALES PRICE |
|----------------|-------------|-------|--------------|--------------|-------------------|-------------------------------|------------------------|---------|----------------------|
| Δ see colors | | | LM | W | LM/W | K | RA | HRS | EURO |
| 4419.122.55.3Δ | PREVALED AC | Osram | 1100 | 14 | 73 | 3000 | >80 | 50.000 | INT. DRIVER € 165,00 |
| 4419.123.55.3Δ | PREVALED AC | Osram | 1100 | 13 | 79 | 4000 | >80 | 50.000 | INT. DRIVER € 165,00 |
| 4419.124.55.3Δ | PREVALED AC | Osram | 2000 | 28 | 71 | 3000 | >80 | 50.000 | INT. DRIVER € 180,00 |
| 4419.125.55.3Δ | PREVALED AC | Osram | 2000 | 26 | 74 | 4000 | >80 | 50.000 | INT. DRIVER € 180,00 |
| 4419.101.55.3Δ | PREVALED AC | Osram | 3000 | 43 | 100 | 3000 | >80 | 50.000 | INT. DRIVER € 195,00 |
| 4419.102.55.3Δ | PREVALED AC | Osram | 3000 | 39 | 110 | 4000 | >80 | 50.000 | INT. DRIVER € 195,00 |
| 4419.101.55.3Δ | PREVALED | Osram | 1100 | 12 | 91 | 3000 | >80 | 50.000 | DRIVER € 180,00 |
| 4419.102.55.3Δ | PREVALED | Osram | 1100 | 12 | 91 | 4000 | >80 | 50.000 | DRIVER € 180,00 |
| 4419.103.55.3Δ | PREVALED | Osram | 2000 | 20 | 100 | 3000 | >80 | 50.000 | DRIVER € 190,00 |
| 4419.104.55.3Δ | PREVALED | Osram | 2000 | 20 | 100 | 4000 | >80 | 50.000 | DRIVER € 190,00 |
| 4419.105.55.3Δ | PREVALED | Osram | 3000 | 30 | 100 | 3000 | >80 | 50.000 | DRIVER € 205,00 |
| 4419.106.55.3Δ | PREVALED | Osram | 3000 | 30 | 100 | 4000 | >80 | 50.000 | DRIVER € 205,00 |

TECHNICAL INFORMATION

PRODUCT

GALAXY



- PRODUCT MATERIAL** ▶ Steel & aluminium
- LIGHT SOURCE** ▶ SLM G4
- MODULE LIFETIME** ▶ Approx. 50.000 hours
- LED COOLING** ▶ Passive cooling
- DRIVER** ▶ Incl. Xitanium driver.
- COLORS (Δ)** ▶
 - 3 = RAL 9003 white
 - 5 = RAL 9005 black
 - 6 = RAL 9006 alu
- BEAM ANGLE** ▶ 80°
- ADJUSTABLE** ▶ No
- SIZE** ▶ 215 X 113MM

OPTIONS

- DIMMABLE** ▶ Dimmable or dali € 45,00
- COLORS** ▶ Available in all RAL colours on request.
Additional price + 10%

INFORMATION

- WARRANTY** ▶ 5 Years

Δ = product color code. See colors

Keylight International B.V. reserves the right to modify or change technical, construction or LED specifications due to continuous improvements of our products and lightsources.



GALAXY

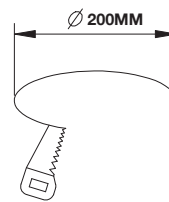

Hole size

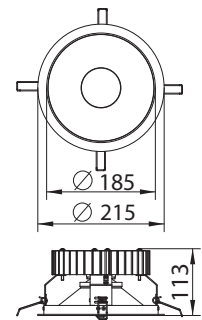

Technical drawing

| ARTICLE NO. | TYPE | LED TYPE | BRAND | LIGHT OUTPUT | MODULE POWER | MODULE EFFICIENCY | CORRELATED COLOUR TEMPERATURE | COLOUR RENDERING INDEX | TC LIFE | SALES PRICE |
|--------------|------------------------|----------|---------|--------------|--------------|-------------------|-------------------------------|------------------------|---------|-------------|
| Δ see colors | | | | LM | W | LM/W | K | RA | HRS | EURO |
| 4420.112.24Δ | SLM 1100-830 | G4 | Philips | 1100 | 10 | 124 | 3000 | 82 | 50.000 | € 230,00 |
| 4420.113.24Δ | SLM 1100-840 | G4 | Philips | 1100 | 10 | 139 | 4000 | 82 | 50.000 | € 230,00 |
| 4420.111.24Δ | SLM 1100-927 | G4 | Philips | 1100 | 10 | 97 | 2700 | 97 | 50.000 | € 230,00 |
| 4420.131.24Δ | SLM 1100-930 | G4 | Philips | 1100 | 10 | 100 | 3000 | 97 | 50.000 | € 230,00 |
| 4420.132.24Δ | SLM 1100-940 | G4 | Philips | 1100 | 10 | 124 | 3000 | 82 | 50.000 | € 230,00 |
| 4420.114.24Δ | SLM 2000-830 | G4 | Philips | 2000 | 17 | 119 | 3000 | 82 | 50.000 | € 235,00 |
| 4420.116.24Δ | SLM 2000-840 | G4 | Philips | 2000 | 17 | 126 | 4000 | 82 | 50.000 | € 235,00 |
| 4420.125.24Δ | SLM 2000-927 | G4 | Philips | 2000 | 17 | 92 | 2700 | 97 | 50.000 | € 235,00 |
| 4420.120.24Δ | SLM 2000-930 | G4 | Philips | 2000 | 17 | 97 | 3000 | 97 | 50.000 | € 235,00 |
| 4420.144.24Δ | SLM 2000-940 | G4 | Philips | 2000 | 17 | 104 | 3000 | 82 | 50.000 | € 235,00 |
| 4420.117.24Δ | SLM 3000-830 | G4 | Philips | 3000 | 26 | 118 | 3000 | 82 | 50.000 | € 245,00 |
| 4420.119.24Δ | SLM 3000-840 | G4 | Philips | 3000 | 26 | 126 | 4000 | 82 | 50.000 | € 245,00 |
| 4420.128.24Δ | SLM 3000-927 | G4 | Philips | 3000 | 26 | 92 | 2700 | 97 | 50.000 | € 245,00 |
| 4420.121.24Δ | SLM 3000-930 | G4 | Philips | 3000 | 26 | 95 | 3000 | 97 | 50.000 | € 245,00 |
| 4420.145.24Δ | SLM 3000-940 | G4 | Philips | 3000 | 26 | 103 | 3000 | 82 | 50.000 | € 245,00 |
| 4420.109.24Δ | SLM 3000-930 CW | G4 | Philips | 3000 | 34 | 88 | CRISP WHITE | 92 | 50.000 | € 265,00 |

TECHNICAL INFORMATION

PRODUCT

JEEP 22



- PRODUCT MATERIAL** ▶ Steel and Alu
- LIGHT SOURCE** ▶ DLM G5
- MODULE LIFETIME** ▶ Approx. 50.000 hours
- LED COOLING** ▶ Passive cooling
- DRIVER** ▶ Incl. Xitanium driver.
- COLORS (Δ)** ▶
 - 3 = RAL 9003 white
 - 5 = RAL 9005 black
 - 6 = RAL 9006 alu
- BEAM ANGLE** ▶ 60°
- ADJUSTABLE** ▶ Yes
- SIZE** ▶ 220 X 166MM

OPTIONS

- COLORS** ▶ Available in all RAL colours on request.
Additional price + 10%
- EMERGENCY BALLAST** ▶ IMP € 225,00
- DIMMABLE** ▶ Dimmable or dali € 45,00

INFORMATION

- WARRANTY** ▶ 5 Years

Δ = product color code. See colors

Keylight International B.V. reserves the right to modify or change technical, construction or LED specifications due to continuous improvements of our products and lightsources.



JEEP 22

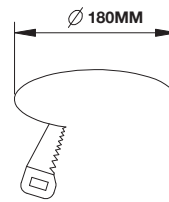

Hole size

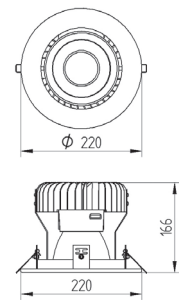

Technical drawing

| ARTICLE NO. | LAMP TYPE | BRAND | LIGHT OUTPUT | MODULE POWER | MODULE EFFICIENCY | CORRELATED COLOUR TEMPERATURE | COLOUR RENDERING INDEX | TC LIFE | POWER FACTOR | SALES PRICE |
|--------------|-----------|---------|--------------|--------------|-------------------|-------------------------------|------------------------|---------|--------------|-------------|
| Δ see colors | | | LM | W | LM/W | K | RA | HRS | PF | EURO |
| 4221.101.60Δ | DLM G5 | Philips | 1100 | 11 | 100 | 3000 | >80 | 50.000 | >,09 | € 275,00 |
| 4221.102.60Δ | DLM G5 | Philips | 1100 | 10 | 110 | 4000 | >80 | 50.000 | >,09 | € 275,00 |
| 4221.103.60Δ | DLM G5 | Philips | 2000 | 22 | 91 | 3000 | >80 | 50.000 | >,09 | € 290,00 |
| 4221.104.60Δ | DLM G5 | Philips | 2000 | 20 | 100 | 4000 | >80 | 50.000 | >,09 | € 290,00 |
| 4221.105.60Δ | DLM G5 | Philips | 3000 | 34 | 88 | 3000 | >80 | 50.000 | >,09 | € 300,00 |
| 4221.106.60Δ | DLM G5 | Philips | 3000 | 32 | 94 | 4000 | >80 | 50.000 | >,09 | € 300,00 |
| 4215.113.99Δ | DLM | FOOD | 2700 | 43 | 65 | 3000 | >75 | 50.000 | >,09 | € 610,00 |
| 4215.134.99Δ | DLM | FOOD | 2700 | 41 | 75 | 4000 | >75 | 50.000 | >,09 | € 610,00 |

TECHNICAL INFORMATION

PRODUCT

MARS 22



- ▶ **PRODUCT MATERIAL** ▶ Die-cast aluminium
- ▶ **LIGHT SOURCE** ▶ DLM-I / DLM G5
- ▶ **MODULE LIFETIME** ▶ DLM-I Approx. 25.000 hours
DLM Approx. 50.000 hours
- ▶ **LED COOLING** ▶ Passive cooling
- ▶ **DRIVER DLM-I** ▶ Incl. 230V intergrated driver.
- ▶ **DRIVER DLM** ▶ Incl. standard xitanium driver.
- ▶ **COLORS** ▶ ● 3 = RAL 9003 white
- ▶ **BEAM ANGLE** ▶ 60°
- ▶ **ADJUSTABLE** ▶ No
- ▶ **SIZE** ▶ 220 X 149MM

OPTIONS

- ▶ **EMERGENCY BALLAST** ▶ DLM: 0187.999.99 1 - 3 hours € 275,00
- ▶ **DIMMABLE** ▶ Dimmable DALI € 45,00

INFORMATION

- ▶ **WARRANTY** ▶ 5 Years.

Δ see colors

Incl. 1.5m cable and plug.

Keylight International B.V. reserves the right to modify or change technical, construction or LED specifications due to continuous improvements of our products and lightsources.



MARS 22

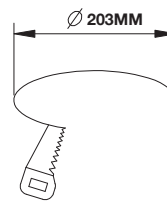

Hole size

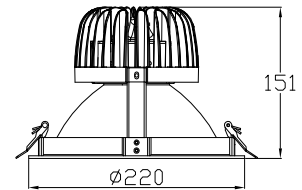

Technical drawing

| ARTICLE NO. | LAMP TYPE | BRAND | LIGHT OUTPUT | | MODULE EFFICIENCY | CORRELATED COLOUR TEMPERATURE | COLOUR RENDERING INDEX | TC LIFE | POWER FACTOR | SALES PRICE |
|---------------|---------------|---------|--------------|------|-------------------|-------------------------------|------------------------|---------|--------------|-------------|
| | | | LM | W | | | | | | |
| 4022.122.60.3 | DLM-Int | Philips | 1100 | 15 | 73 | 3000 | >80 | 25.000 | >,09 | € 135,00 |
| 4022.123.60.3 | DLM-Int | Philips | 1100 | 14 | 79 | 4000 | >80 | 25.000 | >,09 | € 135,00 |
| 4022.124.60.3 | DLM-Int | Philips | 2000 | 28 | 71 | 3000 | >80 | 25.000 | >,09 | € 140,00 |
| 4022.125.60.3 | DLM-Int | Philips | 2000 | 27 | 74 | 4000 | >80 | 25.000 | >,09 | € 140,00 |
| 4022.101.60.3 | DLM FLEX 1100 | Philips | 1279 | 10.1 | 128 | 3000 | >80 | 60.000 | >,09 | € 140,00 |
| 4022.102.60.3 | DLM FLEX 1100 | Philips | 1279 | 9.1 | 141 | 4000 | >80 | 60.000 | >,09 | € 140,00 |
| 4022.103.60.3 | DLM FLEX 2000 | Philips | 2326 | 18.1 | 129 | 3000 | >80 | 60.000 | >,09 | € 150,00 |
| 4022.104.60.3 | DLM FLEX 2000 | Philips | 2326 | 16.5 | 141 | 4000 | >80 | 60.000 | >,09 | € 150,00 |
| 4022.105.60.3 | DLM FLEX 3000 | Philips | 3488 | 27 | 129 | 3000 | >80 | 60.000 | >,09 | € 170,00 |
| 4022.106.60.3 | DLM FLEX 3000 | Philips | 3488 | 24.7 | 141 | 4000 | >80 | 60.000 | >,09 | € 170,00 |

TECHNICAL INFORMATION

PRODUCT

AUSTIN 32



- PRODUCT MATERIAL** ▶ Steel and Alu
- LIGHT SOURCE** ▶ Ledplate
- MODULE LIFETIME** ▶ Approx. 50.000 hours
- LED COOLING** ▶ Passive cooling
- COLORS** ▶
 - 3 = RAL 9003 white
 - 5 = RAL 9005 black
 - 6 = RAL 9006 alu
- DIFFUSER** ▶ Opal
- ADJUSTABLE** ▶ Yes
- SIZE** ▶ 320 X 97MM

OPTIONS

- COLORS** ▶ Available in all RAL colours on request
Additional price + 10%
- DIMMABLE** ▶ Dimmable or dali € 45,00

INFORMATION

Opal diffuser can be mounted on 2 different levels with a flat white ring or recessed into the luminaire.

Δ see colors

Keylight International B.V. reserves the right to modify or change technical, construction or LED specifications due to continuous improvements of our products and lightsources.



AUSTIN 32

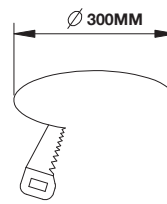

Hole size

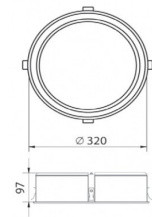

Technical drawing

| ARTICLE NO. | LAMP TYPE | BRAND | LIGHT OUTPUT | MODULE POWER | MODULE EFFICIENCY | CORRELATED COLOUR TEMPERATURE | COLOUR RENDERING INDEX | TC LIFE | POWER FACTOR | SALES PRICE |
|--------------|-----------|-------|--------------|--------------|-------------------|-------------------------------|------------------------|---------|--------------|-------------|
| Δ see colors | | | LM | W | LM/W | K | RA | HRS | PF | EURO |
| 4032.181.91Δ | LED Plate | Osram | 1350 | 16 | 84 | 3000 | >80 | 50.000 | >09, | € 320,00 |
| 4032.182.91Δ | LED Plate | Osram | 1900 | 23 | 83 | 3000 | >80 | 50.000 | >09, | € 320,00 |
| 4032.183.91Δ | LED Plate | Osram | 2500 | 33 | 76 | 3000 | >80 | 50.000 | >09, | € 320,00 |
| 4032.184.91Δ | LED Plate | Osram | 1400 | 16 | 87 | 4000 | >80 | 50.000 | >09, | € 320,00 |
| 4032.185.91Δ | LED Plate | Osram | 2000 | 23 | 87 | 4000 | >80 | 50.000 | >09, | € 320,00 |
| 4032.186.91Δ | LED Plate | Osram | 2600 | 33 | 79 | 4000 | >80 | 50.000 | >09, | € 320,00 |

TECHNICAL INFORMATION

PRODUCT

AUSTIN 58



- PRODUCT MATERIAL** ▶ Steel and Alu
- LIGHT SOURCE** ▶ Ledplate
- MODULE LIFETIME** ▶ Approx. 50.000 hours
- LED COOLING** ▶ Passive cooling
- COLORS** ▶
 - 3 = RAL 9003 white
 - 5 = RAL 9005 black
 - 6 = RAL 9006 alu
- DIFFUSER** ▶ Opal
- ADJUSTABLE** ▶ Yes
- SIZE** ▶ 583 X 162MM

OPTIONS

- COLORS** ▶ Available in all RAL colours on request
Additional price + 10%
- DIMMABLE** ▶ Dimmable or dali € 45,00

INFORMATION

Opal diffuser can be mounted on 2 different levels with a flat white ring or recessed into the luminaire.

Δ see colors

Keylight International B.V. reserves the right to modify or change technical, construction or LED specifications due to continuous improvements of our products and lightsources.



AUSTIN 58

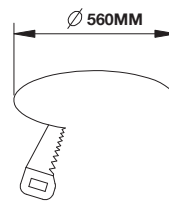

Hole size

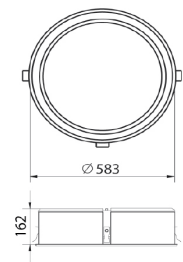

Technical drawing

| ARTICLE NO. | LAMP TYPE | BRAND | LIGHT OUTPUT | MODULE POWER | MODULE EFFICIENCY | CORRELATED COLOUR TEMPERATURE | COLOUR RENDERING INDEX | TC LIFE | POWER FACTOR | SALES PRICE |
|--------------|-----------|-------|--------------|--------------|-------------------|-------------------------------|------------------------|---------|--------------|-------------|
| Δ see colors | | | LM | W | LM/W | K | RA | HRS | PF | EURO |
| 4033.181.91Δ | LED Plate | Osram | 3900 | 28 | 140 | 3000 | >80 | 50.000 | >09, | € 550,00 |
| 4033.182.91Δ | LED Plate | Osram | 3900 | 28 | 140 | 4000 | >80 | 50.000 | >09, | € 550,00 |
| 4033.184.91Δ | LED Plate | Osram | 5200 | 37 | 140 | 3000 | >80 | 50.000 | >09, | € 630,00 |
| 4033.185.91Δ | LED Plate | Osram | 5200 | 37 | 140 | 4000 | >80 | 50.000 | >09, | € 630,00 |



Recessed Square

ALEXANDER

MC
ER MOUEN





GHIBLI S
PAGE 64



GHIBLI S2
PAGE 65

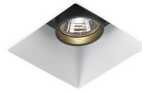

GHIBLI S TRIM
PAGE 66

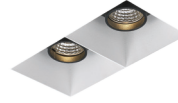

GHIBLI S2 TRIM
PAGE 67

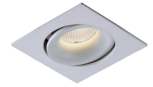

CAP S1
PAGE 68

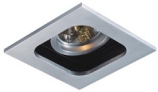

QUASAR 12-1
PAGE 72

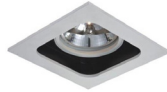

QUASAR 19-1
PAGE 73



QUASAR 19-2
PAGE 74



POXY 1
PAGE 75



POXY 2
PAGE 76



TRIMLESS 18
PAGE 80



TRIMLESS 10
PAGE 81



TRIMLESS 20
PAGE 82



BASIC 13 & 17
PAGE 83 & 84



NITRO 10 & 13
PAGE 85 & 86

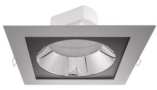

MONACO 16 & 18
PAGE 90 & 91



UTAH 18
PAGE 92



THUNDER 1
PAGE 93



THUNDER 2
PAGE 94



THUNDER 3
PAGE 95



NOX S 18
PAGE 99



QUAD 16 & 20
PAGE 100 & 101



BODY 30
PAGE 102



NORFOLK
PAGE 103

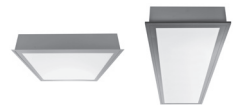

ROOM 60 & 120
PAGE 104 & 105



CAP S2
PAGE 69

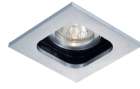

QUASAR 10-1
PAGE 70

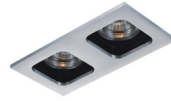

QUASAR 10-2
PAGE 71



POXY 3
PAGE 77



POXY 4
PAGE 78



TRIMLESS 9
PAGE 79



ORION 11
PAGE 87



SQUARE 1
PAGE 88



SQUARE 2
PAGE 89



LUXX 1
PAGE 96



LUXX 2
PAGE 97



LUXX 3
PAGE 98



INSERT 60 LED
PAGE 106



ARC 60
PAGE 107

Recessed Square

| | |
|----------------|--------|
| GHIBLI S | PAGE 1 |
| GHIBLI S2 | PAGE 1 |
| GHIBLI S TRIM | PAGE 1 |
| GHIBLI S2 TRIM | PAGE 1 |
| CAP S1 | PAGE 1 |
| CAP S2 | PAGE 1 |
| QUASAR 10-1 | PAGE 1 |
| QUASAR 10-2 | PAGE 1 |
| QUASAR | PAGE 1 |
| CAP R2 | PAGE 1 |
| LINKON 13 | PAGE 1 |
| LINKON 14L | PAGE 1 |
| UTAH 22 | PAGE 1 |
| UTAH 18 | PAGE 1 |
| YORK | PAGE 1 |
| DL 180 | PAGE 1 |
| KANSAS 16 | PAGE 1 |
| DEEP 22 | PAGE 1 |
| VISION 15 | PAGE 1 |
| VISION 20 | PAGE 1 |
| ROLED | PAGE 1 |
| CAP R1 | PAGE 1 |
| CAP R2 | PAGE 1 |
| LINKON 13 | PAGE 1 |
| LINKON 14L | PAGE 1 |
| UTAH 22 | PAGE 1 |
| UTAH 18 | PAGE 1 |
| YORK | PAGE 1 |
| DL 180 | PAGE 1 |
| KANSAS 16 | PAGE 1 |
| DEEP 22 | PAGE 1 |
| VISION 15 | PAGE 1 |
| VISION 20 | PAGE 1 |
| ROLED | PAGE 1 |
| CAP R1 | PAGE 1 |
| CAP R2 | PAGE 1 |
| LINKON 13 | PAGE 1 |
| LINKON 14L | PAGE 1 |
| UTAH 22 | PAGE 1 |
| UTAH 22 | PAGE 1 |

TECHNICAL INFORMATION

PRODUCT

GHIBLI S



| | | |
|-------------------------|---|--|
| PRODUCT MATERIAL | ▶ | Die-cast aluminium |
| LIGHT SOURCE | ▶ | Bridgelux V8 |
| DRIVER | ▶ | Including driver |
| COLORSΔ | ▶ | <ul style="list-style-type: none"> ● 35 = RAL 9003 white + black ● 5 = RAL 9005 black ● 7 = RAL 7037 grey |
| BEAM ANGLE | ▶ | 26° |
| ADJUSTABLE | ▶ | Yes |
| SIZE | ▶ | 92 X 92 X 113MM |

OPTIONS

| | | | | |
|---|---|--|---|-------|
| OPTIONAL BEAM ANGLE | ▶ | 38° Reflector | € | 5,00 |
| | | art. no.: 4912.999.38.9 | | |
| REFLECTOR RING | ▶ | White reflector ring | € | 9,50 |
| | | art. no.: 4912.922.99.3 | | |
| | | Black reflector ring | € | 9,50 |
| | | art. no.: 4912.922.99.5 | | |
| | | Gold reflector ring | € | 9,50 |
| | | art. no.: 4912.922.99.9 | | |
| GLASS | ▶ | Transparent | € | 7,50 |
| | | art. no.: 4912.933.99.0 | | |
| | | Honey Comb | € | 7,50 |
| | | art. no.: 4912.933.94.0 | | |
| | | Frosted | € | 7,50 |
| | | art. no.: 4912.933.90.0 | | |
| | | Striped | € | 7,50 |
| | | art. no.: 4912.933.96.0 | | |
| DIMMABLE DRIVER IN COMBINATION WITH GHIBLI S | ▶ | OSRAM 8.5W 1/10v 350mA | € | 23,50 |
| | | art. no.: 0110.999.99.0 | | |
| | | OSRAM 13W Leading & trailing edge | € | 23,50 |
| | | art. no.: 0111.999.99.0 | | |
| | | Lumotech 20W 1/10v 500mA | € | 27,50 |
| | | art. no.: 0137.999.99.0 | | |
| | | Lumotech 12W Mains trailing edge 500mA | € | 27,50 |
| | | art. no.: 0135.500.99.0 | | |

INFORMATION

Including cable and plug

Keylight International B.V. reserves the right to modify or change technical, construction or LED specifications due to continuous improvements of our products and light sources.



GHIBLI S

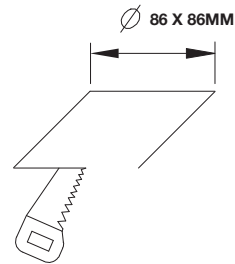

Hole size

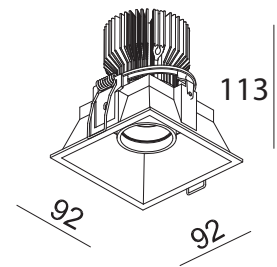

Technical drawing

| ARTICLE NO. | LAMP TYPE | BRAND | LIGHT OUTPUT | MODULE POWER | MODULE EFFICIENCY | CORRELATED COLOUR TEMPERATURE | COLOUR RENDERING INDEX | TC LIFE | mA | SALES PRICE |
|---------------|-----------|-----------|--------------|--------------|-------------------|-------------------------------|------------------------|---------|-----|-------------|
| Δ see colors | | | LM | W | LM/W | K | RA | HRS | mA | EURO |
| 4912.179.26.Δ | V8 LED | Bridgelux | 565 | 6.2 | 91 | 2700 | >90 | 50.000 | 350 | € 90,00 |
| 4912.180.26.Δ | V8 LED | Bridgelux | 675 | 9.3 | 84 | 2700 | >90 | 50.000 | 500 | € 90,00 |

TECHNICAL INFORMATION

PRODUCT

GHIBLI S2



- PRODUCT MATERIAL** ▶ Die-cast aluminium
- LIGHT SOURCE** ▶ Bridgelux V8
- DRIVER** ▶ Including Philips driver
- COLORS Δ** ▶
 - 35 = RAL 9003 white + black
 - 5 = RAL 9005 black
 - 7 = RAL 7037 grey
- BEAM ANGLE** ▶ 26°
- ADJUSTABLE** ▶ Yes
- SIZE** ▶ 174 X 92 X 113MM

OPTIONS

- OPTIONAL BEAM ANGLE** ▶ 38° Reflector € 10,00
art. no.: 4912.999.38.9
- REFLECTOR RING (2X)** ▶ White reflector ring € 19,00
art. no.: 4912.922.99.3
Black reflector ring € 19,00
art. no.: 4912.922.99.5
Gold reflector ring € 19,00
art. no.: 4912.922.99.9
- GLASS (2X)** ▶ Transparent € 15,00
art. no.: 4912.933.99.0
Honey Comb € 15,00
art. no.: 4912.933.94.0
Frosted € 15,00
art. no.: 4912.933.90.0
Striped € 15,00
art. no.: 4912.933.96.0
- DIMMABLE DRIVER (2X) IN COMBINATION WITH GHIBLI S2** ▶ Lumotech 20W 1/10v 350mA € 23,50
art. no.: 0136.999.99.0
OSRAM 18W Leading & trailing edge 350 mA € 23,50
art. no.: 0113.999.99.0

INFORMATION

Including cable and plug
Keylight International B.V. reserves the right to modify or change technical, construction or LED specifications due to continuous improvements of our products and light sources.



GHIBLI S2

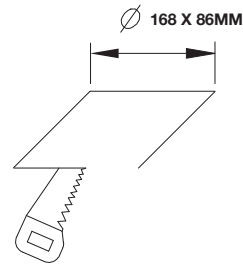

Hole size

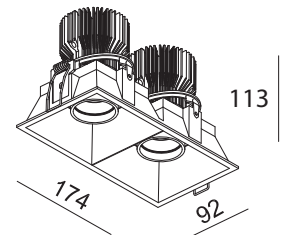

Technical drawing

| ARTICLE NO. | LAMP TYPE | BRAND | LIGHT OUTPUT | MODULE POWER | MODULE EFFICIENCY | CORRELATED COLOUR TEMPERATURE | COLOUR RENDERING INDEX | TC LIFE | mA | SALES PRICE |
|-----------------------|-----------|-----------|--------------|--------------|-------------------|-------------------------------|------------------------|-----------|--------|-------------|
| Δ see colors | | | LM | W | LM/W | K | RA | HRS | mA | EURO |
| 4919.179.26. Δ | V8 LED | Bridgelux | 2X 565 | 2x 6.2 | 2X 91 | 2X 2700 | >90 | 2X 50.000 | 2X 350 | € 195,00 |
| 4919.180.26. Δ | V8 LED | Bridgelux | 2X 675 | 2x 9.3 | 2X 84 | 2X 2700 | >90 | 2X 50.000 | 2X 500 | € 195,00 |

TECHNICAL INFORMATION

PRODUCT

GHIBLI S TRIM



| | |
|-------------------------|---|
| PRODUCT MATERIAL | ▶ Die-cast aluminium |
| LIGHT SOURCE | ▶ Bridgelux V8 |
| DRIVER | ▶ Including driver |
| COLORS | ▶ ● 35 = RAL 9003 white + black ● 5 = RAL 9005 black ● 7 = RAL 7037 grey |
| BEAM ANGLE | ▶ 26° |
| ADJUSTABLE | ▶ Yes |
| SIZE | ▶ 84 X 84 X 113MM |

OPTIONS

| | | |
|--|---|---------|
| OPTIONAL BEAM ANGLE | ▶ 38° Reflector art. no.: 4912.999.38.9 | € 5,00 |
| REFLECTOR RING | ▶ White reflector ring art. no.: 4912.922.99.3 | € 9,50 |
| | ▶ Black reflector ring art. no.: 4912.922.99.5 | € 9,50 |
| | ▶ Gold reflector ring art. no.: 4912.922.99.9 | € 9,50 |
| GLASS | ▶ Transparent art. no.: 4912.933.99.0 | € 7,50 |
| | ▶ Honey Comb art. no.: 4912.933.94.0 | € 7,50 |
| | ▶ Frosted art. no.: 4912.933.90.0 | € 7,50 |
| | ▶ Striped art. no.: 4912.933.96.0 | € 7,50 |
| DIMMABLE DRIVER IN COMBINATION WITH GHIBLI S TRIM | ▶ OSRAM 8,5W 1/10v 350mA art. no.: 0110.999.99.0 | € 23,50 |
| | ▶ OSRAM 13W Leading & trailing edge art. no.: 0111.999.99.0 | € 23,50 |
| | ▶ Lumotech 20W 1/10v 500mA art. no.: 0137.999.99.0 | € 27,50 |
| | ▶ Lumotech 12W Mains trailing edge 500mA art. no.: 0135.500.99.0 | € 27,50 |

INFORMATION

Including cable and plug

Luminaire includes an easy mounting plasterkit

Keylight International B.V. reserves the right to modify or change technical, construction or LED specifications due to continuous improvements of our products and lightsources.

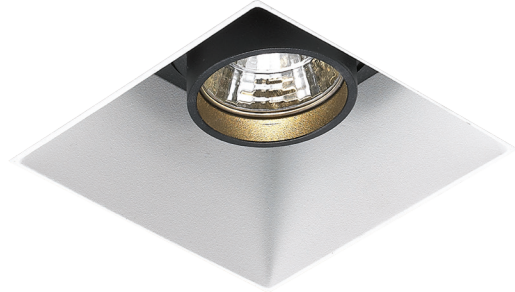

GHIBLI S TRIM

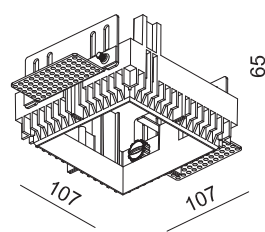

Hole size = 110 x 110 x 140mm

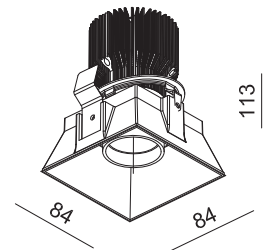

Technical drawing

| ARTICLE NO. | LAMP TYPE | BRAND | LIGHT OUTPUT | MODULE POWER | MODULE EFFICIENCY | CORRELATED COLOUR TEMPERATURE | COLOUR RENDERING INDEX | TC LIFE | mA | SALES PRICE |
|---------------|-----------|-----------|--------------|--------------|-------------------|-------------------------------|------------------------|---------|-----|-------------|
| Δ see colors | | | LM | W | LM/W | K | RA | HRS | mA | EURO |
| 4913.179.26.Δ | V8 LED | Bridgelux | 565 | 6.2 | 91 | 2700 | >90 | 50.000 | 350 | € 115,00 |
| 4913.180.26.Δ | V8 LED | Bridgelux | 675 | 9.3 | 84 | 2700 | >90 | 50.000 | 500 | € 115,00 |

TECHNICAL INFORMATION

PRODUCT

GHIBLI S2 TRIM



- PRODUCT MATERIAL** ▶ Die-cast aluminium
- LIGHT SOURCE** ▶ Bridgelux V8
- DRIVER** ▶ Including Philips driver
- COLORS** ▶
 - 35 = RAL 9003 white + black
 - 5 = RAL 9005 black
 - 7 = RAL 7037 grey
- BEAM ANGLE** ▶ 26°
- ADJUSTABLE** ▶ Yes
- SIZE** ▶ 166 X 84 X 113MM

OPTIONS

- OPTIONAL BEAM ANGLE** ▶ 38° Reflector € 10,00
art. no.: 4912.999.38.9
- REFLECTOR RING (2X)** ▶ White reflector ring € 19,00
art. no.: 4912.922.99.3
Black reflector ring € 19,00
art. no.: 4912.922.99.5
Gold reflector ring € 19,00
art. no.: 4912.922.99.9
- GLASS (2X)** ▶ Transparent € 15,00
art. no.: 4912.933.99.0
Honey Comb € 15,00
art. no.: 4912.933.94.0
Frosted € 15,00
art. no.: 4912.933.90.0
Striped € 15,00
art. no.: 4912.933.96.0
- DIMMABLE DRIVER (2X) IN COMBINATION WITH GHIBLI S2** ▶ Lumotech 20W 1/10v 350mA € 23,50
art. no.: 0136.999.99.0
OSRAM 18W Leading & trailing edge 350 mA € 23,50
art. no.: 0113.999.99.0

INFORMATION

Including cable and plug

Luminaire includes an easy mounting plasterkit

Keylight International B.V. reserves the right to modify or change technical, construction or LED specifications due to continuous improvements of our products and lightsources.



GHIBLI S2 TRIM

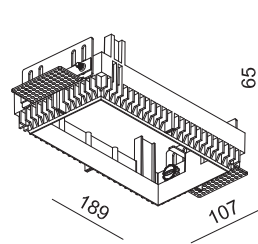

Hole size = 191 x 110 x 140mm

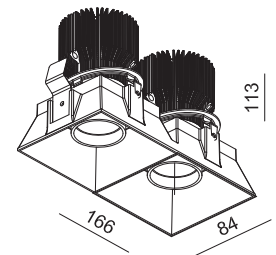

Technical drawing

| ARTICLE NO. | LAMP TYPE | BRAND | LIGHT OUTPUT | MODULE POWER | MODULE EFFICIENCY | CORRELATED COLOUR TEMPERATURE | COLOUR RENDERING INDEX | TC LIFE | mA | SALES PRICE |
|---------------|-----------|-----------|--------------|--------------|-------------------|-------------------------------|------------------------|-----------|--------|-------------|
| Δ see colors | | | LM | W | LM/W | K | RA | HRS | mA | EURO |
| 4914.179.26.Δ | V8 LED | Bridgelux | 2X 565 | 2x 6.2 | 2X 91 | 2X 2700 | >90 | 2X 50.000 | 2X 350 | € 225,00 |
| 4914.180.26.Δ | V8 LED | Bridgelux | 2X 675 | 2x 9.3 | 2X 84 | 2X 2700 | >90 | 2X 50.000 | 2X 500 | € 225,00 |

TECHNICAL INFORMATION

PRODUCT

CAP S1



- PRODUCT MATERIAL** ▶ Die-cast aluminium
- LIGHT SOURCE** ▶ Bridgelux
- MODULE LIFETIME** ▶ Approx. 50.000 hours
- LED COOLING** ▶ Passive cooling
- DRIVER** ▶ Incl. driver + cable and plug standard
- COLORS (Δ)** ▶
 - 3 = RAL 9003 white
 - 5 = RAL 9005 black
 - 6 = RAL 9006 alu
- BEAM ANGLE** ▶ 28°
- ADJUSTABLE** ▶ Yes
- SIZE** ▶ 105 X 105 X 77MM

OPTIONS

- GLASS COVER CLEAR** ▶ Glass IP44 € 7,50
art. no.: 0053.999.99.0
- GLASS FILTER** ▶ Filter 2600K glass € 30,00
art. no.: 4006.999.27.0
- DIMMABLE DRIVER** ▶ OSRAM 8.5W 1/10v 350mA € 23,50
art. no.: 0110.999.99.0
- IN COMBINATION WITH CAP S1**
 - OSRAM 13W phase-cut 350 mA € 23,50
art. no.: 0111.999.99.0

INFORMATION

- WARRANTY** ▶ 5 Years

Δ = product color code. See colors

This luminaire is "plug & play".

Incl. 1.5m cable and plug.

Keylight International B.V. reserves the right to modify or change technical, construction or LED specifications due to continuous improvements of our products and lightsources.



CAP R1

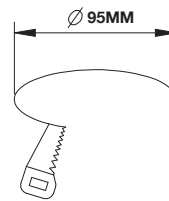

Hole size

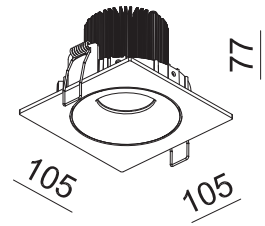

Technical drawing

| ARTICLE NO. | LAMP TYPE | BRAND | LIGHT OUTPUT | MODULE POWER | MODULE EFFICIENCY | CORRELATED COLOUR TEMPERATURE | COLOUR RENDERING INDEX | TC LIFE | MA | SALES PRICE |
|--------------|-----------|-----------|--------------|--------------|-------------------|-------------------------------|------------------------|---------|-----|-------------|
| Δ see colors | | | LM | W | LM/W | K | CRI | HRS | mA | EURO |
| 4501.990.28Δ | BXRA | Bridgelux | 600 | 6.6 | 86 | 3000 | >80 | 50.000 | 350 | € 75,00 |

TECHNICAL INFORMATION

PRODUCT

CAP S2



- PRODUCT MATERIAL** ▶ Die-cast aluminium
- LIGHT SOURCE** ▶ Bridgelux
- MODULE LIFETIME** ▶ Approx. 50.000 hours
- LED COOLING** ▶ Passive cooling
- DRIVER** ▶ Incl. driver + cable and plug standard
- COLORS (Δ)** ▶
 - 3 = RAL 9003 white
 - 5 = RAL 9005 black
 - 6 = RAL 9006 alu
- BEAM ANGLE** ▶ 2X 28°
- ADJUSTABLE** ▶ Yes
- SIZE** ▶ 208 X 105 X 70MM

OPTIONS

- GLASS COVER CLEAR** ▶ 2x Glass IP44 € 15,00
art. no.: 0053.999.99.0
- GLASS FILTER** ▶ 2x Filter 2600K glass € 60,00
art. no.: 4006.999.27.0
- DIMMABLE DRIVER (2X)** ▶ Lumotech 20W 1/10v 350mA € 23,50
art. no.: 0136.999.99.0
- IN COMBINATION WITH CAP S2**
 - OSRAM 18W Leading & trailing edge 350 mA € 23,50
art. no.: 0113.999.99.0

INFORMATION

- WARRANTY** ▶ 5 Years

Δ = product color code. See colors

This luminaire is "plug & play".

Incl. 2x 1.5m cable and plug.

Keylight International B.V. reserves the right to modify or change technical, construction or LED specifications due to continuous improvements of our products and lightsources.



CAP S2

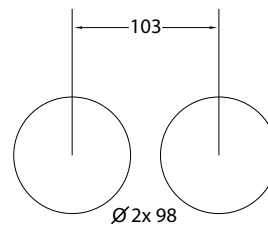

Hole size

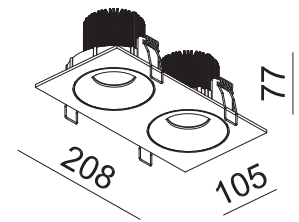

Technical drawing

| ARTICLE NO. | LAMP TYPE | BRAND | LIGHT OUTPUT | MODULE POWER | MODULE EFFICIENCY | CORRELATED COLOUR TEMPERATURE | COLOUR RENDERING INDEX | TC LIFE | MA | SALES PRICE |
|--------------|-----------|-----------|--------------|--------------|-------------------|-------------------------------|------------------------|---------|-----|-------------|
| Δ see colors | | | LM | W | LM/W | K | CRI | HRS | mA | EURO |
| 4208.990.28Δ | BXRA | Bridgelux | 2X 600 | 2X 6.6 | 86 | 3000 | >80 | 50.000 | 350 | € 145,00 |

TECHNICAL INFORMATION

PRODUCT

QUASAR 10-1



- PRODUCT MATERIAL** ▶ Aluminium + Die-cast aluminium
- LIGHT SOURCE** ▶ MR16 LED / LMR50
- DRIVER** ▶ LMR 50 includes a driver
- COLORS (Δ)** ▶
 - + ● 35 = RAL 9003 + black
 - + ● 55 = RAL 9005 + black
 - + ● 65 = Alu brush + black
- BEAM ANGLE** ▶ LMR: 20° / 30°
- ADJUSTABLE** ▶ Yes
- SIZE** ▶ 100 X 100 X 50/90MM

OPTIONS LMR

- DIMMABLE DRIVER** ▶ OSRAM 8,5W 1/10v 350mA € 23,50
art. no.: 0110.999.99.0
- OSRAM 13W phase-cut 350 mA € 23,50
art. no.: 0111.999.99.0
- OPTIONAL FRONT RING** ▶ LMR50 Aluminium colour. € 3,95
art. no.: 0052.999.99.6
- MOUNTING BRACKET** ▶ LMR50 incl. mounting set € 5,00
art. no.: 0051.999.99.5
- GLASS COVER CLEAR** ▶ LMR50 glass IP44 € 7,50
art. no.: 0053.999.99.0

INFORMATION

LMR including cable, plug, connection cable and driver.

! Only luminaire body, lightsource and/or driver excluded.

Keylight International B.V. reserves the right to modify or change technical, construction or LED specifications due to continuous improvements of our products and lightsources.

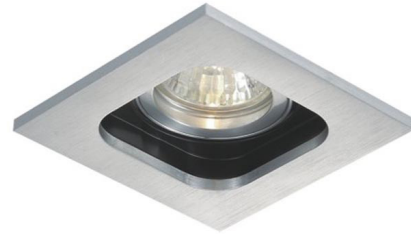

QUASAR 10-1

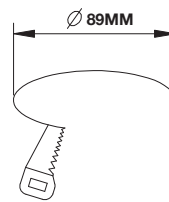

Hole size

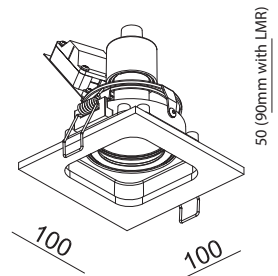

Technical drawing



LMR50

| ARTICLE NO. | LAMP TYPE | BRAND | LIGHT OUTPUT | MODULE POWER | MODULE EFFICIENCY | CORRELATED COLOUR TEMPERATURE | COLOUR RENDERING INDEX | TC LIFE | REFL. | mA | SALES PRICE |
|-----------------------|-----------|-----------|--------------|--------------|-------------------|-------------------------------|------------------------|---------|--------|-----|-------------|
| Δ see colors | | | LM | W | LM/W | K | RA | HRS | DEGREE | mA | EURO |
| ! 4906.999.99Δ | Gu5.3 | | | Max. 50W | | | | | | | € 22,50 |
| ! 4906.999.99Δ | Gu10 | | | Max. 50W | | | | | | | € 22,50 |
| 4906.171.20Δ | LMR50 | Bridgelux | 560 | 6.6 | 79 | 2700 | >80 | 25.000 | 20° | 350 | € 65,00 |
| 4906.172.30Δ | LMR50 | Bridgelux | 560 | 6.6 | 79 | 2700 | >80 | 25.000 | 30° | 350 | € 65,00 |
| 4906.173.20Δ | LMR50 | Bridgelux | 600 | 6.6 | 86 | 3000 | >80 | 25.000 | 20° | 350 | € 65,00 |
| 4906.174.30Δ | LMR50 | Bridgelux | 600 | 6.6 | 86 | 3000 | >80 | 25.000 | 30° | 350 | € 65,00 |

TECHNICAL INFORMATION

PRODUCT

QUASAR 10-2



- PRODUCT MATERIAL** ▶ Aluminium + Die-cast aluminium
- LIGHT SOURCE** ▶ MR16 LED / LMR50
- DRIVER** ▶ LMR 50 includes a driver
- COLORS (Δ)** ▶
 - + ● 35 = RAL 9003 + black
 - + ● 55 = RAL 9005 + black
 - + ● 65 = Alu brush + black
- BEAM ANGLE** ▶ LMR: 20° / 30°
- ADJUSTABLE** ▶ Yes
- SIZE** ▶ 200 X 100 X 50/90MM

OPTIONS LMR

- DIMMABLE DRIVER (2X) IN COMBINATION WITH QUASAR 10-2** ▶
 - Lumotech 20W 1/10v 350mA € 23,50
art. no.: 0136.999.99.0
 - OSRAM 18W Leading & trailing edge 350 mA € 23,50
art. no.: 0113.999.99.0
- OPTIONAL FRONT RING** ▶ LMR50 Aluminium colour. € 8,90
art. no.: 0052.999.99.6
- MOUNTING BRACKET** ▶ LMR50 incl. mounting set € 10,00
art. no.: 0051.999.99.5
- GLASS COVER CLEAR** ▶ LMR50 glass IP44 € 15,00
art. no.: 0053.999.99.0

INFORMATION

LMR including cable, plug, connection cable and driver.

! Only luminaire body, lightsource and/or driver excluded.

Keylight International B.V. reserves the right to modify or change technical, construction or LED specifications due to continuous improvements of our products and lightsources.

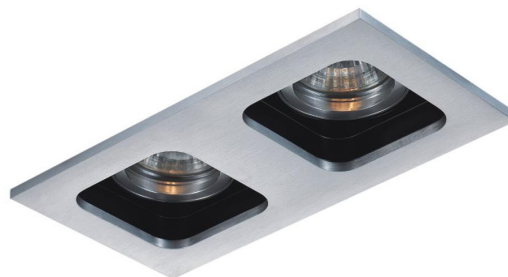

QUASAR 10-2

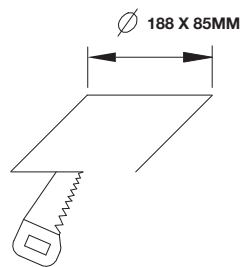

Hole size

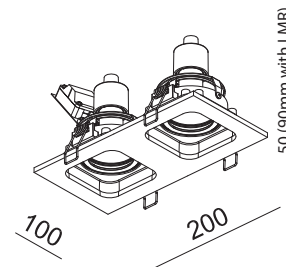

Technical drawing



LMR50

| ARTICLE NO. | LAMP TYPE | BRAND | LIGHT OUTPUT | MODULE POWER | MODULE EFFICIENCY | CORRELATED COLOUR TEMPERATURE | COLOUR RENDERING INDEX | TC LIFE | REFL. | mA | SALES PRICE |
|-----------------------|-----------|-----------|--------------|--------------|-------------------|-------------------------------|------------------------|---------|--------|-----|-------------|
| Δ see colors | | | LM | W | LM/W | K | RA | HRS | DEGREE | mA | EURO |
| ! 4907.999.99Δ | Gu5.3 | | | Max. 50W | | | | | | | € 42,50 |
| ! 4907.999.99Δ | Gu10 | | | Max. 50W | | | | | | | € 42,50 |
| 4907.171.20Δ | LMR50 | Bridgelux | 2 X 560 | 2 X 6.6 | 79 | 2700 | >80 | 25.000 | 20° | 350 | € 125,00 |
| 4907.172.30Δ | LMR50 | Bridgelux | 2 X 560 | 2 X 6.6 | 79 | 2700 | >80 | 25.000 | 30° | 350 | € 125,00 |
| 4907.173.20Δ | LMR50 | Bridgelux | 2 X 600 | 2 X 6.6 | 86 | 3000 | >80 | 25.000 | 20° | 350 | € 125,00 |
| 4907.174.30Δ | LMR50 | Bridgelux | 2 X 600 | 2 X 6.6 | 86 | 3000 | >80 | 25.000 | 30° | 350 | € 125,00 |

TECHNICAL INFORMATION

PRODUCT

QUASAR 12-1



- PRODUCT MATERIAL** ▶ Aluminium + Die-cast aluminium
- LIGHT SOURCE** ▶ QR70 LED / LMR70
- DRIVER** ▶ LMR 70 includes a driver
- COLORS (Δ)** ▶
 - + ● 35 = RAL 9003 + black
 - + ● 55 = RAL 9005 + black
 - + ● 65 = Alu brush + black
- BEAM ANGLE** ▶ LMR: 20° / 30°
- ADJUSTABLE** ▶ Yes
- SIZE** ▶ 123 X 123 X 55/90MM

OPTIONS LMR

- DIMMABLE DRIVER** ▶
 - LMR70 8.5w Dim. 1/10v € 37,00
 - LMR70 10w Dim. phase-cut € 35,00
- OPTIONAL FRONT RING** ▶ LMR70 Aluminium colour. € 3,95
- MOUNTING BRACKET** ▶ LMR70 incl. mounting set € 5,00

INFORMATION

LMR including cable, plug, connection cable and driver.

! Only luminaire body, lightsource and/or driver excluded.

Keylight International B.V. reserves the right to modify or change technical, construction or LED specifications due to continuous improvements of our products and lightsources.

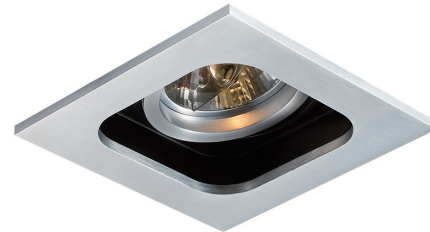

QUASAR 12-1

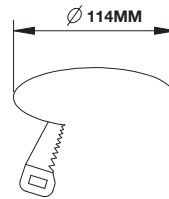

Hole size

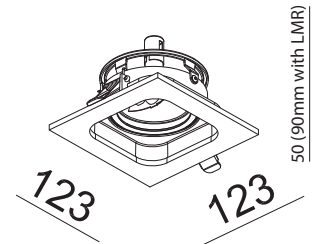

Technical drawing



LMR70

| ARTICLE NO. | LAMP TYPE | BRAND | LIGHT OUTPUT | MODULE POWER | MODULE EFFICIENCY | CORRELATED COLOUR TEMPERATURE | COLOUR RENDERING INDEX | TC LIFE | REFL. | mA | SALES PRICE |
|-----------------------|-----------|-----------|--------------|--------------|-------------------|-------------------------------|------------------------|---------|--------|-----|-------------|
| Δ see colors | | | LM | W | LM/W | K | RA | HRS | DEGREE | mA | EURO |
| ! 4903.309.98Δ | QR70 | | | Max. 50W | | | | | | | € 39,50 |
| 4903.171.20Δ | LMR70 | Bridgelux | 1330 | 15 | 89 | 2700 | >80 | 25.000 | 20° | 350 | € 90,00 |
| 4903.172.30Δ | LMR70 | Bridgelux | 1330 | 15 | 89 | 2700 | >80 | 25.000 | 30° | 350 | € 90,00 |
| 4903.173.20Δ | LMR70 | Bridgelux | 1410 | 15 | 94 | 3000 | >80 | 25.000 | 20° | 350 | € 90,00 |
| 4903.174.30Δ | LMR70 | Bridgelux | 1410 | 15 | 94 | 3000 | >80 | 25.000 | 30° | 350 | € 90,00 |

TECHNICAL INFORMATION

PRODUCT

QUASAR 19-1



- ▶ **PRODUCT MATERIAL** Aluminium + Die-cast aluminium
- ▶ **LIGHT SOURCE** QR111 LED
- ▶ **DRIVER** Excluded
- ▶ **COLORS (Δ)**
 - + ● 35 = RAL 9003 + black
 - + ● 55 = RAL 9005 + black
 - + ● 65 = Alu brush + black
- ▶ **ADJUSTABLE** Yes
- ▶ **SIZE** 190 X 190 X 125MM

OPTIONS

- ▶ **COLOR TEMP.** 927 / 930 / 940
- ▶ **BEAM ANGLE** 40° (On request)
- ▶ **WATTAGE** Standard 8W, optional 12W

INFORMATION

! Including Osram Parathom PRO

Keylight International B.V. reserves the right to modify or change technical, construction or LED specifications due to continuous improvements of our products and lightsources.



QUASAR 19-1

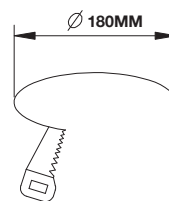

Hole size

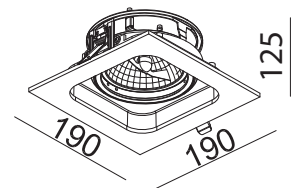

Technical drawing

| ARTICLE NO. | LAMP TYPE | BRAND | LIGHT OUTPUT | MODULE POWER | MODULE EFFICIENCY | CORRELATED COLOUR TEMPERATURE | COLOUR RENDERING INDEX | TC LIFE | REFL. | SALES PRICE |
|-----------------------|-----------|-------|--------------|--------------|-------------------|-------------------------------|------------------------|---------|-------|-------------|
| Δ see colors | | | LM | W | LM/W | K | RA | HRS | ° | EURO |
| ! 4904.999.24Δ | QR111 | Osram | 450 | 8.5 | 53 | 2700 | 80 | 45.000 | 24 | € 80,00 |

TECHNICAL INFORMATION

PRODUCT

QUASAR 19-2



- PRODUCT MATERIAL ▶ Aluminium + Die-cast aluminium
- LIGHT SOURCE ▶ QR111
- DRIVER ▶ Excluded
- COLORS (Δ) ▶
 - + ● 35 = RAL 9003 + black
 - + ● 55 = RAL 9005 + black
 - + ● 65 = Alu brush + black
- ADJUSTABLE ▶ Yes
- SIZE ▶ 380 X 190 X 125WMM

OPTIONS

- COLOR TEMP. ▶ 927 / 930 / 940
- BEAM ANGLE ▶ 40° (On request)
- WATTAGE ▶ Standard 8W, optional 12W

INFORMATION

! Including Osram Parathom PRO

Keylight International B.V. reserves the right to modify or change technical, construction or LED specifications due to continuous improvements of our products and lightsources.



QUASAR 19-2

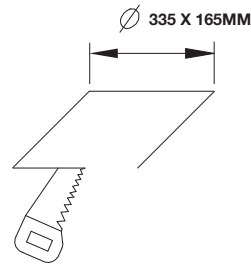

Hole size

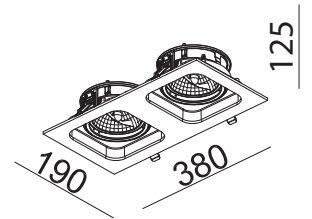

Technical drawing

| ARTICLE NO. | LAMP TYPE | BRAND | LIGHT OUTPUT | MODULE POWER | MODULE EFFICIENCY | CORRELATED COLOUR TEMPERATURE | COLOUR RENDERING INDEX | TC LIFE | REFL. | SALES PRICE |
|-----------------------|-----------|-------|--------------|--------------|-------------------|-------------------------------|------------------------|---------|-------|-------------|
| Δ see colors | | | LM | W | LM/W | K | RA | HRS | ° | EURO |
| ! 4905.999.24Δ | QR111 | Osram | 2X 450 | 2x 8.5 | 2X 53 | 2700 | 80 | 45.000 | 24 | € 155,00 |

TECHNICAL INFORMATION

PRODUCT

POXY 1



- PRODUCT MATERIAL** ▶ Steel and aluminium
- LIGHT SOURCE** ▶ SLM G4
- MODULE LIFETIME** ▶ Approx. 50.000 hours
- LED COOLING** ▶ Fan cooling
- DRIVER** ▶ Incl. Xitanium driver.
- COLORS (Δ)** ▶
 - + ● **35** = RAL 9003 + black
 - + ● **55** = RAL 9005 + black
 - + ● **65** = RAL 9006 + black
- BEAM ANGLE** ▶ 30°
- ADJUSTABLE** ▶ Yes
- SIZE** ▶ 158 X 158 X 130MM

OPTIONS

- EMERGENCY BALLAST** ▶ 0187.999.99 1 - 3 hours. € 215,00
- COLORS** ▶ Available in all RAL colours on request.
Additional price + 10%
- DIMMABLE** ▶ Dimmable or dali on request

INFORMATION

- WARRANTY** ▶ 5 Years
- Δ = product color code. See colors

including cable and plug.

This luminaire can be customized with different RAL color combinations. For example: White inside and black as the outer frame color.

Keylight International B.V. reserves the right to modify or change technical, construction or LED specifications due to continuous improvements of our products and lightsources.



POXY 1

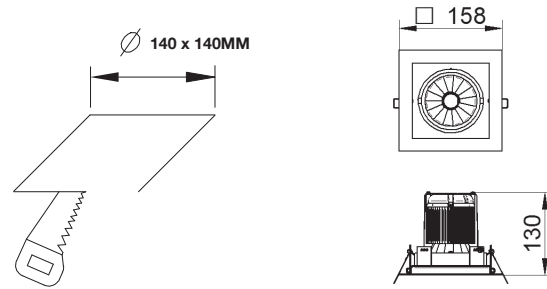

Hole size

Technical drawing

| ARTICLE NO. | LAMP TYPE | BRAND | LIGHT OUTPUT | MODULE POWER | SETTING | MODULE EFFICIENCY | CORRELATED COLOUR TEMPERATURE | COLOUR RENDERING INDEX | B50/L70 AT TC LIFE | SALES PRICE |
|--------------|---------------------|---------|--------------|--------------|------------------|-------------------|-------------------------------|------------------------|--------------------|-------------|
| Δ see colors | GEN 4 | | LM | W | | LM/W | K | RA | HRS | EURO |
| 4158.111.30Δ | SLM 1100-827 L13 # | Philips | 1160 | 10 | High Efficiency | 114 | 2700 | >82 | 50.000 | € 230,00 |
| 4158.112.30Δ | SLM 1100-830 L13 | Philips | 1240 | 10 | High Efficiency | 122 | 3000 | >82 | 50.000 | € 230,00 |
| 4158.113.30Δ | SLM 1100-840 L13 | Philips | 1330 | 10 | High Efficiency | 130 | 4000 | >82 | 50.000 | € 230,00 |
| 4158.114.30Δ | SLM 2000-830 L13 | Philips | 2020 | 17 | High Efficiency | 117 | 3000 | >82 | 50.000 | € 240,00 |
| 4158.116.30Δ | SLM 2000-840 L13 | Philips | 2150 | 17 | High Efficiency | 124 | 4000 | >82 | 50.000 | € 240,00 |
| 4158.125.30Δ | SLM 2000-927 L13 # | Philips | 1570 | 17 | High Efficiency | 91 | 2700 | >97 | 50.000 | € 240,00 |
| 4158.120.30Δ | SLM 2000-930 L13 | Philips | 1650 | 17 | High Efficiency | 95 | 3000 | >97 | 50.000 | € 240,00 |
| 4158.117.30Δ | SLM 3000-830 L15 | Philips | 2970 | 26 | High Efficiency | 114 | 3000 | >82 | 50.000 | € 250,00 |
| 4158.119.30Δ | SLM 3000-840 L15 | Philips | 3170 | 26 | High Efficiency | 122 | 4000 | >82 | 50.000 | € 250,00 |
| 4158.128.30Δ | SLM 3000-927 L15 # | Philips | 2320 | 26 | High Efficiency | 89 | 2700 | >97 | 50.000 | € 250,00 |
| 4158.121.30Δ | SLM 3000-930 L15 | Philips | 2400 | 26 | High Efficiency | 92 | 3000 | >97 | 50.000 | € 250,00 |
| 4158.135.30Δ | SLM 4500-830 L19 | Philips | 4860 | 42 | High Efficiency | 114 | 3000 | >82 | 50.000 | € 260,00 |
| 4158.136.30Δ | SLM 4500-840 L19 | Philips | 5160 | 42 | High Efficiency | 122 | 4000 | >82 | 50.000 | € 260,00 |
| 4158.157.30Δ | SLM 4500-927 L19 | Philips | 3760 | 42 | High Efficiency | 89 | 2700 | >97 | 50.000 | € 265,00 |
| 4158.137.30Δ | SLM 4500-930 L19 | Philips | 3930 | 42 | High Efficiency | 92 | 3000 | >97 | 50.000 | € 265,00 |
| 4158.109.30Δ | SLM CW 3000-930 L15 | Philips | 2790 | 34 | Crisp White | 82 | 3000 | >92 | 50.000 | € 260,00 |
| 4158.110.30Δ | SLM CW 3800-930 L19 | Philips | 2790 | 34 | Crisp White | 82 | 3000 | >92 | 50.000 | € 295,00 |
| 4158.159.30Δ | SLM FW 2800-925 L19 | Philips | 2880 | 42 | Food Warm White | 69 | 2900 | >90 | 50.000 | € 310,00 |
| 4158.160.30Δ | SLM FR 3000-930 L19 | Philips | 2980 | 42 | Food Premium red | 72 | 3150 | >87 | 50.000 | € 310,00 |

* SLM G4: High efficacy is Keylight standard. High value: option for more Lumen flux output (more power, more watt) option on request.
 # SLM 827 + 927. On special request
 - SLM Premium White (colour point bBBL) 2000 Lm / 4500 Lm 3000k, On special request

TECHNICAL INFORMATION

PRODUCT

POXY 2



- PRODUCT MATERIAL** ▶ Steel and aluminium
- LIGHT SOURCE** ▶ SLM G4
- MODULE LIFETIME** ▶ Approx. 50.000 hours
- LED COOLING** ▶ Fan cooling
- DRIVER** ▶ Incl. Xitanium driver.
- COLORS (Δ)** ▶
 - + ● 35 = RAL 9003 + black
 - + ● 55 = RAL 9005 + black
 - + ● 65 = RAL 9006 + black
- BEAM ANGLE** ▶ 30°
- ADJUSTABLE** ▶ Yes
- SIZE** ▶ 275 X 158 X 130MM

OPTIONS

- EMERGENCY BALLAST** ▶ 0187.999.99 1 - 3 hours. € 215,00
- COLORS** ▶ Available in all RAL colours on request.
Additional price + 10%
- DIMMABLE** ▶ Dimmable or dali on request

INFORMATION

WARRANTY ▶ 5 Years

Δ = product color code. See colors

including cable and plug.

This luminaire can be customized with different RAL color combinations. For example: White inside and black as the outer frame color.

Keylight International B.V. reserves the right to modify or change technical, construction or LED specifications due to continuous improvements of our products and lightsources.



POXY 2

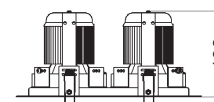
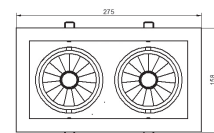
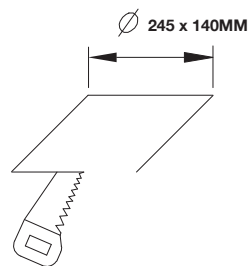

Hole size

Technical drawing

| ARTICLE NO. | LAMP TYPE | BRAND | LIGHT OUTPUT | MODULE POWER | SETTING | MODULE EFFICIENCY | CORRELATED COLOUR TEMPERATURE | COLOUR RENDERING INDEX | B50/L70 AT TC LIFE | SALES PRICE |
|--------------|---------------------|---------|--------------|--------------|------------------|-------------------|-------------------------------|------------------------|--------------------|-------------|
| Δ see colors | GEN 4 | | LM | W | | LM/W | K | RA | HRS | EURO |
| 4275.111.30Δ | SLM 1100-827 L13 # | Philips | 1160 | 10 | High Efficiency | 114 | 2700 | >82 | 50.000 | € 480,00 |
| 4275.112.30Δ | SLM 1100-830 L13 | Philips | 1240 | 10 | High Efficiency | 122 | 3000 | >82 | 50.000 | € 480,00 |
| 4275.113.30Δ | SLM 1100-840 L13 | Philips | 1330 | 10 | High Efficiency | 130 | 4000 | >82 | 50.000 | € 480,00 |
| 4275.114.30Δ | SLM 2000-830 L13 | Philips | 2020 | 17 | High Efficiency | 117 | 3000 | >82 | 50.000 | € 485,00 |
| 4275.116.30Δ | SLM 2000-840 L13 | Philips | 2150 | 17 | High Efficiency | 124 | 4000 | >82 | 50.000 | € 485,00 |
| 4275.125.30Δ | SLM 2000-927 L13 # | Philips | 1570 | 17 | High Efficiency | 91 | 2700 | >97 | 50.000 | € 485,00 |
| 4275.120.30Δ | SLM 2000-930 L13 | Philips | 1650 | 17 | High Efficiency | 95 | 3000 | >97 | 50.000 | € 485,00 |
| 4275.117.30Δ | SLM 3000-830 L15 | Philips | 2970 | 26 | High Efficiency | 114 | 3000 | >82 | 50.000 | € 495,00 |
| 4275.119.30Δ | SLM 3000-840 L15 | Philips | 3170 | 26 | High Efficiency | 122 | 4000 | >82 | 50.000 | € 495,00 |
| 4275.128.30Δ | SLM 3000-927 L15 # | Philips | 2320 | 26 | High Efficiency | 89 | 2700 | >97 | 50.000 | € 495,00 |
| 4275.121.30Δ | SLM 3000-930 L15 | Philips | 2400 | 26 | High Efficiency | 92 | 3000 | >97 | 50.000 | € 495,00 |
| 4275.135.24Δ | SLM 4500-830 L19 | Philips | 4860 | 42 | High Efficiency | 114 | 3000 | >82 | 50.000 | € 510,00 |
| 4275.136.24Δ | SLM 4500-840 L19 | Philips | 5160 | 42 | High Efficiency | 122 | 4000 | >82 | 50.000 | € 510,00 |
| 4275.157.24Δ | SLM 4500-927 L19 | Philips | 3760 | 42 | High Efficiency | 89 | 2700 | >97 | 50.000 | € 515,00 |
| 4275.137.24Δ | SLM 4500-930 L19 | Philips | 3930 | 42 | High Efficiency | 92 | 3000 | >97 | 50.000 | € 515,00 |
| 4275.109.30Δ | SLM CW 3000-930 L15 | Philips | 2790 | 34 | Crisp White | 82 | 3000 | >92 | 50.000 | € 510,00 |
| 4275.110.30Δ | SLM CW 3800-930 L19 | Philips | 2790 | 34 | Crisp White | 82 | 3000 | >92 | 50.000 | € 545,00 |
| 4275.159.30Δ | SLM FW 2800-925 L19 | Philips | 2880 | 42 | Food Warm White | 69 | 2900 | >90 | 50.000 | € 560,00 |
| 4275.160.30Δ | SLM FR 3000-930 L19 | Philips | 2980 | 42 | Food Premium red | 72 | 3150 | >87 | 50.000 | € 560,00 |

* SLM G4: High efficacy is Keylight standard. High value: option for more Lumen flux output (more power, more watt) option on request.

SLM 827 + 927. On special request

- SLM Premium White (colour point bBBL) 2000 Lm / 4500 Lm 3000k, On special request

TECHNICAL INFORMATION

PRODUCT

POXY 3



- PRODUCT MATERIAL** ▶ Steel and aluminium
- LIGHT SOURCE** ▶ SLM G4
- MODULE LIFETIME** ▶ Approx. 50.000 hours
- LED COOLING** ▶ Fan cooling
- DRIVER** ▶ Incl. Xitanium driver.
- COLORS (Δ)** ▶
 - + ● **35** = RAL 9003 + black
 - + ● **55** = RAL 9005 + black
 - + ● **65** = RAL 9006 + black
- BEAM ANGLE** ▶ 30°
- ADJUSTABLE** ▶ Yes
- SIZE** ▶ 392 X 158 X 130MM

OPTIONS

- EMERGENCY BALLAST** ▶ 0187.999.99 1 - 3 hours. € 215,00
- COLORS** ▶ Available in all RAL colours on request.
Additional price + 10%
- DIMMABLE** ▶ Dimmable or dali on request

INFORMATION

- WARRANTY** ▶ 5 Years
- Δ = product color code. See colors

including cable and plug.

This luminaire can be customized with different RAL color combinations. For example: White inside and black as the outer frame color.

Keylight International B.V. reserves the right to modify or change technical, construction or LED specifications due to continuous improvements of our products and lightsources.



POXY 3

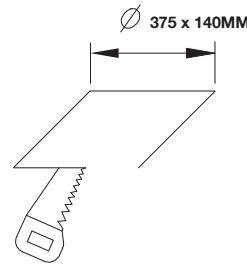

Hole size

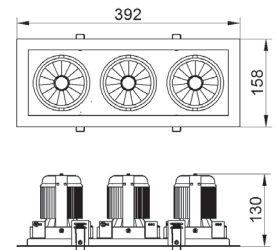

Technical drawing

| ARTICLE NO. | LAMP TYPE | BRAND | LIGHT OUTPUT | MODULE POWER | SETTING | MODULE EFFICIENCY | CORRELATED COLOUR TEMPERATURE | COLOUR RENDERING INDEX | B50/L70 AT TC LIFE | SALES PRICE |
|---------------|---------------------|---------|--------------|--------------|------------------|-------------------|-------------------------------|------------------------|--------------------|-------------|
| Δ see colors | GEN 4 | | LM | W | | LM/W | K | RA | HRS | EURO |
| 4330.111.30Δ | SLM 1100-827 L13 # | Philips | 1160 | 10 | High Efficiency | 114 | 2700 | >82 | 50.000 | € 725,00 |
| 4330.112.30Δ | SLM 1100-830 L13 | Philips | 1240 | 10 | High Efficiency | 122 | 3000 | >82 | 50.000 | € 725,00 |
| 4330.113.30Δ | SLM 1100-840 L13 | Philips | 1330 | 10 | High Efficiency | 130 | 4000 | >82 | 50.000 | € 725,00 |
| 4330.114.30Δ | SLM 2000-830 L13 | Philips | 2020 | 17 | High Efficiency | 117 | 3000 | >82 | 50.000 | € 730,00 |
| 4330.116.30Δ | SLM 2000-840 L13 | Philips | 2150 | 17 | High Efficiency | 124 | 4000 | >82 | 50.000 | € 730,00 |
| 4330.125.30Δ | SLM 2000-927 L13 # | Philips | 1570 | 17 | High Efficiency | 91 | 2700 | >97 | 50.000 | € 730,00 |
| 4330.120.30Δ | SLM 2000-930 L13 | Philips | 1650 | 17 | High Efficiency | 95 | 3000 | >97 | 50.000 | € 730,00 |
| 4330.117.30Δ | SLM 3000-830 L15 | Philips | 2970 | 26 | High Efficiency | 114 | 3000 | >82 | 50.000 | € 740,00 |
| 4330.119.30Δ | SLM 3000-840 L15 | Philips | 3170 | 26 | High Efficiency | 122 | 4000 | >82 | 50.000 | € 740,00 |
| 4330.128.30Δ | SLM 3000-927 L15 # | Philips | 2320 | 26 | High Efficiency | 89 | 2700 | >97 | 50.000 | € 740,00 |
| 4330.121.30Δ | SLM 3000-930 L15 | Philips | 2400 | 26 | High Efficiency | 92 | 3000 | >97 | 50.000 | € 740,00 |
| 4330.135.24.Δ | SLM 4500-830 L19 | Philips | 4860 | 42 | High Efficiency | 114 | 3000 | >82 | 50.000 | € 760,00 |
| 4330.136.24.Δ | SLM 4500-840 L19 | Philips | 5160 | 42 | High Efficiency | 122 | 4000 | >82 | 50.000 | € 760,00 |
| 4330.157.24.Δ | SLM 4500-927 L19 | Philips | 3760 | 42 | High Efficiency | 89 | 2700 | >97 | 50.000 | € 765,00 |
| 4330.137.24.Δ | SLM 4500-930 L19 | Philips | 3930 | 42 | High Efficiency | 92 | 3000 | >97 | 50.000 | € 765,00 |
| 4330.109.30Δ | SLM CW 3000-930 L15 | Philips | 2790 | 34 | Crisp White | 82 | 3000 | >92 | 50.000 | € 760,00 |
| 4330.110.30Δ | SLM CW 3800-930 L19 | Philips | 2790 | 34 | Crisp White | 82 | 3000 | >92 | 50.000 | € 795,00 |
| 4330.159.30Δ | SLM FW 2800-925 L19 | Philips | 2880 | 42 | Food Warm White | 69 | 2900 | >90 | 50.000 | € 810,00 |
| 4330.160.30Δ | SLM FR 3000-930 L19 | Philips | 2980 | 42 | Food Premium red | 72 | 3150 | >87 | 50.000 | € 810,00 |

* SLM G4: High efficacy is Keylight standard, High value: option for more Lumen flux output (more power, more watt) option on request.
 # SLM 827 + 927, On special request
 - SLM Premium White (colour point bBBL) 2000 Lm / 4500 Lm 3000k, On special request

TECHNICAL INFORMATION

PRODUCT

POXY 4



- PRODUCT MATERIAL** ▶ Steel and aluminium
- LIGHT SOURCE** ▶ SLM G4
- MODULE LIFETIME** ▶ Approx. 50.000 hours
- LED COOLING** ▶ Fan cooling
- DRIVER** ▶ Incl. Xitanium driver.
- COLORS (Δ)** ▶
 - + ● 35 = RAL 9003 + black
 - + ● 55 = RAL 9005 + black
 - + ● 65 = RAL 9006 + black
- BEAM ANGLE** ▶ 30°
- ADJUSTABLE** ▶ Yes
- SIZE** ▶ 275 X 275 X 130MM

OPTIONS

- EMERGENCY BALLAST** ▶ 0187.999.99 1 - 3 hours. € 215,00
- COLORS** ▶ Available in all RAL colours on request.
Additional price + 10%
- DIMMABLE** ▶ Dimmable or dali on request

INFORMATION

WARRANTY ▶ 5 Years

Δ = product color code. See colors

including cable and plug.

This luminaire can be customized with different RAL color combinations. For example: White inside and black as the outer frame color.

Keylight International B.V. reserves the right to modify or change technical, construction or LED specifications due to continuous improvements of our products and lightsources.



POXY 2

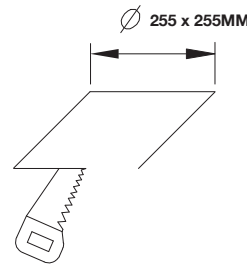

Hole size

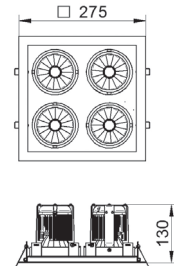

Technical drawing

| ARTICLE NO. | LAMP TYPE | BRAND | LIGHT OUTPUT | MODULE POWER | SETTING | MODULE EFFICIENCY | CORRELATED COLOUR TEMPERATURE | COLOUR RENDERING INDEX | B50/L70 AT TC LIFE | SALES PRICE |
|---------------|---------------------|---------|--------------|--------------|------------------|-------------------|-------------------------------|------------------------|--------------------|-------------|
| Δ see colors | GEN 4 | | LM | W | | LM/W | K | RA | HRS | EURO |
| 4575.111.30Δ | SLM 1100-827 L13 # | Philips | 1160 | 10 | High Efficiency | 114 | 2700 | >82 | 50.000 | € 970,00 |
| 4575.112.30Δ | SLM 1100-830 L13 | Philips | 1240 | 10 | High Efficiency | 122 | 3000 | >82 | 50.000 | € 970,00 |
| 4575.113.30Δ | SLM 1100-840 L13 | Philips | 1330 | 10 | High Efficiency | 130 | 4000 | >82 | 50.000 | € 970,00 |
| 4575.114.30Δ | SLM 2000-830 L13 | Philips | 2020 | 17 | High Efficiency | 117 | 3000 | >82 | 50.000 | € 975,00 |
| 4575.116.30Δ | SLM 2000-840 L13 | Philips | 2150 | 17 | High Efficiency | 124 | 4000 | >82 | 50.000 | € 975,00 |
| 4575.125.30Δ | SLM 2000-927 L13 # | Philips | 1570 | 17 | High Efficiency | 91 | 2700 | >97 | 50.000 | € 975,00 |
| 4575.120.30Δ | SLM 2000-930 L13 | Philips | 1650 | 17 | High Efficiency | 95 | 3000 | >97 | 50.000 | € 975,00 |
| 4575.117.30Δ | SLM 3000-830 L15 | Philips | 2970 | 26 | High Efficiency | 114 | 3000 | >82 | 50.000 | € 985,00 |
| 4575.119.30Δ | SLM 3000-840 L15 | Philips | 3170 | 26 | High Efficiency | 122 | 4000 | >82 | 50.000 | € 985,00 |
| 4575.128.30Δ | SLM 3000-927 L15 # | Philips | 2320 | 26 | High Efficiency | 89 | 2700 | >97 | 50.000 | € 985,00 |
| 4575.121.30Δ | SLM 3000-930 L15 | Philips | 2400 | 26 | High Efficiency | 92 | 3000 | >97 | 50.000 | € 985,00 |
| 4575.135.24.Δ | SLM 4500-830 L19 | Philips | 4860 | 42 | High Efficiency | 114 | 3000 | >82 | 50.000 | € 995,00 |
| 4575.136.24.Δ | SLM 4500-840 L19 | Philips | 5160 | 42 | High Efficiency | 122 | 4000 | >82 | 50.000 | € 995,00 |
| 4575.157.24.Δ | SLM 4500-927 L19 | Philips | 3760 | 42 | High Efficiency | 89 | 2700 | >97 | 50.000 | € 1010,00 |
| 4575.137.24.Δ | SLM 4500-930 L19 | Philips | 3930 | 42 | High Efficiency | 92 | 3000 | >97 | 50.000 | € 1010,00 |
| 4575.109.30Δ | SLM CW 3000-930 L15 | Philips | 2790 | 34 | Crisp White | 82 | 3000 | >92 | 50.000 | € 995,00 |
| 4575.110.30Δ | SLM CW 3800-930 L19 | Philips | 2790 | 34 | Crisp White | 82 | 3000 | >92 | 50.000 | € 1045,00 |
| 4575.159.30Δ | SLM FW 2800-925 L19 | Philips | 2880 | 42 | Food Warm White | 69 | 2900 | >90 | 50.000 | € 1060,00 |
| 4575.160.30Δ | SLM FR 3000-930 L19 | Philips | 2980 | 42 | Food Premium red | 72 | 3150 | >87 | 50.000 | € 1060,00 |

* SLM G4: High efficacy is Keylight standard. High value: option for more Lumen flux output (more power, more watt) option on request.
 # SLM 827 + 927. On special request
 - SLM Premium White (colour point bBBL) 2000 Lm / 4500 Lm 3000k , On special request

TECHNICAL INFORMATION

PRODUCT

TRIMLESS 9



- PRODUCT MATERIAL ▶ Steel
- LIGHT SOURCE ▶ MR16 / GU10 / LMR50
- DRIVER ▶ LMR 50 includes a driver
- COLORS (Δ) ▶
 - 3 = RAL 9003 white
 - 5 = RAL 9005 black
 - 6 = RAL 9006 alu
- BEAM ANGLE ▶ LMR: 20° / 30°
- ADJUSTABLE ▶ Yes
- SIZE ▶ 90.5 X 90.5 X 107MM

OPTIONS LMR

- DIMMABLE DRIVER IN COMBINATION WITH TRIMLESS 9 ▶
 - OSRAM 8.5W 1/10v 350mA € 23,50
art. no.: 0110.999.99.0
 - OSRAM 13W phase-cut 350 mA € 23,50
art. no.: 0111.999.99.0
- OPTIONAL FRONT RING ▶ LMR50 Aluminium colour. € 3,95
art. no.: 0052.999.99.6
- MOUNTING BRACKET ▶ LMR50 incl. mounting set € 5,00
art. no.: 0051.999.99.5
- GLASS COVER CLEAR ▶ LMR50 glass IP44 € 7,50
art. no.: 0053.999.99.0

INFORMATION

LMR including cable, plug, connection cable and driver.

! Only luminaire body, lightsource and/or driver excluded.

- Luminaire includes an easy mounting plasterkit

Keylight International B.V. reserves the right to modify or change technical, construction or LED specifications due to continuous improvements of our products and lightsources.



TRIMLESS 9

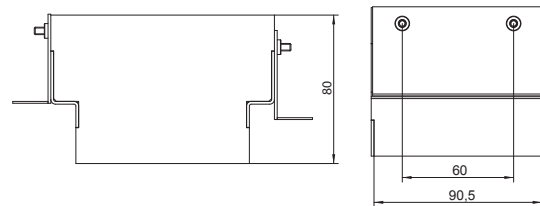

Technical drawing (Mounting plasterkit)



LMR50

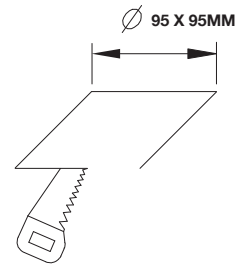

Hole size

| ARTICLE NO. | LAMP TYPE | BRAND | LIGHT OUTPUT | MODULE POWER | MODULE EFFICIENCY | CORRELATED COLOUR TEMPERATURE | COLOUR RENDERING INDEX | TC LIFE | REFL. | mA | SALES PRICE |
|-----------------------|-----------|-----------|--------------|--------------|-------------------|-------------------------------|------------------------|---------|--------|-----|-------------|
| Δ see colors | | | LM | W | LM/W | K | RA | HRS | DEGREE | mA | EURO |
| ! 4906.999.99Δ | Gu5.3 | | | Max. 50W | | | | | | | € 70,00 |
| ! 4906.999.99Δ | Gu10 | | | Max. 50W | | | | | | | € 70,00 |
| 4906.171.20Δ | LMR50 | Bridgelux | 560 | 6.6 | 79 | 2700 | >80 | 25.000 | 20° | 350 | € 110,00 |
| 4906.172.30Δ | LMR50 | Bridgelux | 560 | 6.6 | 79 | 2700 | >80 | 25.000 | 30° | 350 | € 110,00 |
| 4906.173.20Δ | LMR50 | Bridgelux | 600 | 6.6 | 86 | 3000 | >80 | 25.000 | 20° | 350 | € 110,00 |
| 4906.174.30Δ | LMR50 | Bridgelux | 600 | 6.6 | 86 | 3000 | >80 | 25.000 | 30° | 350 | € 110,00 |

TECHNICAL INFORMATION

PRODUCT

TRIMLESS 18



- PRODUCT MATERIAL** ▶ Steel
- LIGHT SOURCE** ▶ MR16 / GU10 / LMR50
- DRIVER** ▶ LMR 50 includes a driver
- COLORS (Δ)** ▶
 - 3 = RAL 9003 white
 - 5 = RAL 9005 black
 - 6 = RAL 9006 alu
- BEAM ANGLE** ▶ LMR: 20° / 30°
- ADJUSTABLE** ▶ Yes
- SIZE** ▶ 173.5 X 90.5 X 107MM

OPTIONS LMR

- DIMMABLE DRIVER (2X) IN COMBINATION WITH TRIMLESS 18** ▶
 - OSRAM 8.5W 1/10v 350mA € 23,50
art. no.: 0110.999.99.0
 - OSRAM 13W phase-cut 350 mA € 23,50
art. no.: 0111.999.99.0
- OPTIONAL FRONT RING** ▶ LMR50 Aluminium colour. € 7,90
2x art. no.: 0052.999.99.6
- MOUNTING BRACKET** ▶ LMR50 incl. mounting set € 10,00
2x art. no.: 0051.999.99.5
- GLASS COVER CLEAR** ▶ LMR50 glass IP44 € 15,00
2x art. no.: 0053.999.99.0

INFORMATION

LMR including cable, plug, connection cable and driver.



Only luminaire body, lightsource and/or driver excluded.

- Luminaire includes an easy mounting plasterkit

Keylight International B.V. reserves the right to modify or change technical, construction or LED specifications due to continuous improvements of our products and lightsources.

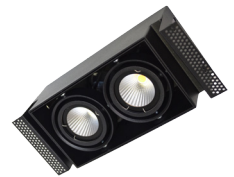

TRIMLESS 18

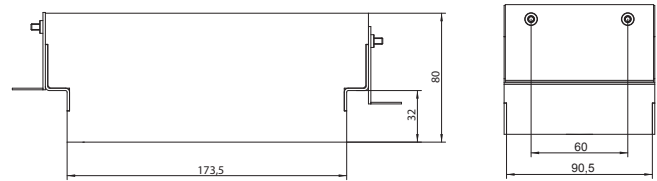

Technical drawing (Mounting plasterkit)



LMR50

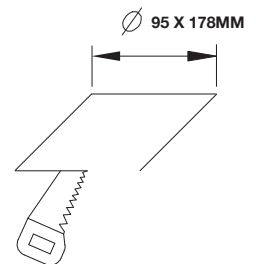

Hole size

| ARTICLE NO. | LAMP TYPE | BRAND | LIGHT OUTPUT | MODULE POWER | MODULE EFFICIENCY | CORRELATED COLOUR TEMPERATURE | COLOUR RENDERING INDEX | TC LIFE | REFL. | mA | SALES PRICE |
|-----------------------|-----------|-----------|--------------|--------------|-------------------|-------------------------------|------------------------|---------|--------|-----|-------------|
| Δ see colors | | | LM | W | LM/W | K | RA | HRS | DEGREE | mA | EURO |
| ! 4604.309.98Δ | QR70 | | | Max. 50W | | | | | | | € 110,00 |
| 4604.171.20Δ | LMR50 | Bridgelux | 560 | 6.6 | 79 | 2700 | >80 | 25.000 | 20° | 350 | € 190,00 |
| 4604.172.30Δ | LMR50 | Bridgelux | 560 | 6.6 | 79 | 2700 | >80 | 25.000 | 30° | 350 | € 190,00 |
| 4604.173.20Δ | LMR50 | Bridgelux | 600 | 6.6 | 86 | 3000 | >80 | 25.000 | 20° | 350 | € 190,00 |
| 4604.174.30Δ | LMR50 | Bridgelux | 600 | 6.6 | 86 | 3000 | >80 | 25.000 | 30° | 350 | € 190,00 |

TECHNICAL INFORMATION

PRODUCT

TRIMLESS 10



- PRODUCT MATERIAL ▶ Steel
- LIGHT SOURCE ▶ QR70 / LMR70
- DRIVER ▶ LMR 70 includes a driver
- COLORS (Δ) ▶
 - 3 = RAL 9003 white
 - 5 = RAL 9005 black
 - 6 = RAL 9006 alu
- BEAM ANGLE ▶ LMR: 20° / 30°
- ADJUSTABLE ▶ Yes
- SIZE ▶ 108.5 X 108.50 X 80.5MM

INFORMATION

LMR including cable, plug, connection cable and driver.

- ! Only luminaire body, lightsource and/or driver excluded.
- Luminaire includes an easy mounting plasterkit

Keylight International B.V. reserves the right to modify or change technical, construction or LED specifications due to continuous improvements of our products and lightsources.



TRIMLESS 10

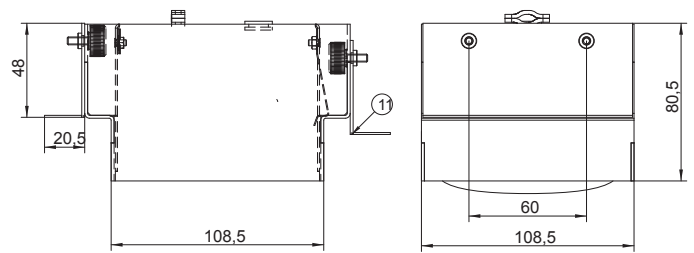

Technical drawing



LMR70

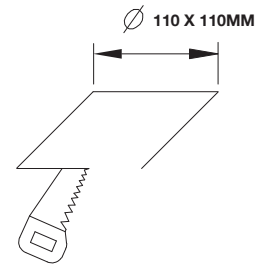

Hole size

| ARTICLE NO. | LAMP TYPE | BRAND | LIGHT OUTPUT | MODULE POWER | MODULE EFFICIENCY | CORRELATED COLOUR TEMPERATURE | COLOUR RENDERING INDEX | TC LIFE | REFL. | mA | SALES PRICE |
|----------------|-----------|-----------|--------------|--------------|-------------------|-------------------------------|------------------------|---------|--------|-----|-------------|
| Δ see colors | | | LM | W | LM/W | K | RA | HRS | DEGREE | mA | EURO |
| ! 4604.309.98Δ | QR70 | | | Max. 50W | | | | | | | € 85,00 |
| 4604.171.20Δ | LMR70 | Bridgelux | 560 | 6.6 | 79 | 2700 | >80 | 25.000 | 20° | 350 | € 135,00 |
| 4604.172.30Δ | LMR70 | Bridgelux | 560 | 6.6 | 79 | 2700 | >80 | 25.000 | 30° | 350 | € 135,00 |
| 4604.173.20Δ | LMR70 | Bridgelux | 600 | 6.6 | 86 | 3000 | >80 | 25.000 | 20° | 350 | € 135,00 |
| 4604.174.30Δ | LMR70 | Bridgelux | 600 | 6.6 | 86 | 3000 | >80 | 25.000 | 30° | 350 | € 135,00 |

TECHNICAL INFORMATION

PRODUCT

TRIMLESS 20



- PRODUCT MATERIAL** ▶ Steel
- LIGHT SOURCE** ▶ QR70 / LMR70
- DRIVER** ▶ LMR 70 includes a driver
- COLORS (Δ)** ▶
 - 3 = RAL 9003 white
 - 5 = RAL 9005 black
 - 6 = RAL 9006 alu
- BEAM ANGLE** ▶ LMR: 20° / 30°
- ADJUSTABLE** ▶ Yes
- SIZE** ▶ 213 X 105,5 X 80MM

OPTIONS LMR

- DIMMABLE DRIVER** ▶ LMR70 17w Dim. 1/10v € 37,00
LMR70 15w Dim. phase-cut € 35,00
- OPTIONAL FRONT RING** ▶ LMR70 Aluminium colour. € 3,95
- MOUNTING BRACKET** ▶ LMR70 incl. mounting set € 5,00

INFORMATION

LMR including cable, plug, connection cable and driver.

! Only luminaire body, lightsource and/or driver excluded.

- Luminaire includes an easy mounting plasterkit

Keylight International B.V. reserves the right to modify or change technical, construction or LED specifications due to continuous improvements of our products and lightsources.



TRIMLESS 20

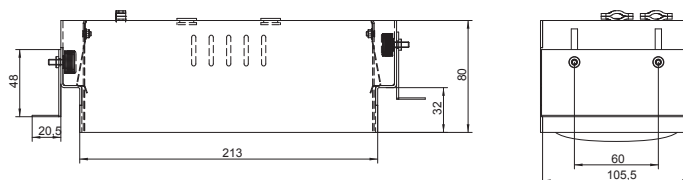

Technical drawing



LMR70

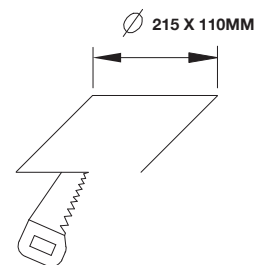

Hole size

| ARTICLE NO. | LAMP TYPE | BRAND | LIGHT OUTPUT | MODULE POWER | MODULE EFFICIENCY | CORRELATED COLOUR TEMPERATURE | COLOUR RENDERING INDEX | TC LIFE | REFL. | mA | SALES PRICE |
|-----------------------|-----------|-----------|--------------|--------------|-------------------|-------------------------------|------------------------|---------|--------|-----|-------------|
| Δ see colors | | | LM | W | LM/W | K | RA | HRS | DEGREE | mA | EURO |
| ! 4642.309.98Δ | QR70 | | | Max. 50W | | | | | | | € 120,00 |
| 4642.171.20Δ | LMR70 | Bridgelux | 2 X 1330 | 2 X 15 | 89 | 2700 | >80 | 25.000 | 20° | 350 | € 235,00 |
| 4642.172.30Δ | LMR70 | Bridgelux | 2 X 1330 | 2 X 15 | 89 | 2700 | >80 | 25.000 | 30° | 350 | € 235,00 |
| 4642.173.20Δ | LMR70 | Bridgelux | 2 X 1410 | 2 X 15 | 94 | 3000 | >80 | 25.000 | 20° | 350 | € 235,00 |
| 4642.174.30Δ | LMR70 | Bridgelux | 2 X 1410 | 2 X 15 | 94 | 3000 | >80 | 25.000 | 30° | 350 | € 235,00 |

TECHNICAL INFORMATION

PRODUCT

BASIC 13



- PRODUCT MATERIAL** ▶ Die-cast aluminium
- LIGHT SOURCE** ▶ MR16 LED / LMR50
- DRIVER** ▶ LMR 50 includes a driver
- COLORS (Δ)** ▶
 - 3 = RAL 9003 White
 - 5 = RAL 9005 Black
- BEAM ANGLE** ▶ LMR: 20° / 30°
- ADJUSTABLE** ▶ Yes
- SIZE** ▶ 130 X 130 X 43/100MM

OPTIONS LMR

- DIMMABLE DRIVER IN COMBINATION WITH BASIC 13** ▶
 - OSRAM 8,5W 1/10v 350mA € 23,50
art. no.: 0110.999.99.0
 - OSRAM 13W phase-cut 350 mA € 23,50
art. no.: 0111.999.99.0
- OPTIONAL FRONT RING** ▶ LMR50 Aluminium colour. € 3,95
art. no.: 0052.999.99.6
- MOUNTING BRACKET** ▶ LMR50 incl. mounting set € 5,00
art. no.: 0051.999.99.5
- GLASS COVER CLEAR** ▶ LMR50 glass IP44 € 3,85
art. no.: 0053.999.99.0

INFORMATION

LMR including cable, plug, connection cable and driver.



Only luminaire body, lightsource and/or driver excluded.

Including an assemble plate to mount a single unit into a double, triple, quadruple or "L" shape unit easily in a short time

Keylight International B.V. reserves the right to modify or change technical, construction or LED specifications due to continuous improvements of our products and lightsources.



BASIC 13

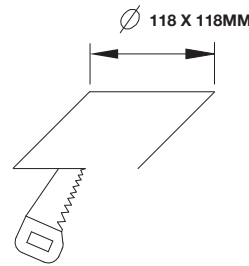

Hole size

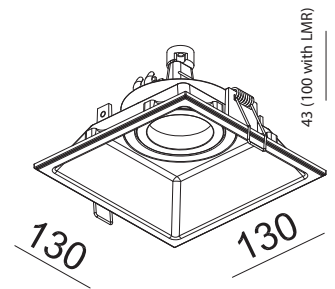

Technical drawing



LMR50

| ARTICLE NO. | LAMP TYPE | BRAND | LIGHT OUTPUT | MODULE POWER | MODULE EFFICIENCY | CORRELATED COLOUR TEMPERATURE | COLOUR RENDERING INDEX | TC LIFE | REFL. | mA | SALES PRICE |
|----------------|-----------|-----------|--------------|--------------|-------------------|-------------------------------|------------------------|---------|--------|-----|-------------|
| Δ see colors | | | LM | W | LM/W | K | RA | HRS | DEGREE | mA | EURO |
| ! 4908.999.99Δ | Gu5.3 | | | Max. 50W | | | | | | | € 22,50 |
| ! 4908.999.99Δ | Gu10 | | | Max. 50W | | | | | | | € 22,50 |
| 4908.171.20Δ | LMR50 | Bridgelux | 560 | 6.6 | 79 | 2700 | >80 | 25.000 | 20° | 350 | € 65,00 |
| 4908.172.30Δ | LMR50 | Bridgelux | 560 | 6.6 | 79 | 2700 | >80 | 25.000 | 30° | 350 | € 65,00 |
| 4908.173.20Δ | LMR50 | Bridgelux | 600 | 6.6 | 86 | 3000 | >80 | 25.000 | 20° | 350 | € 65,00 |
| 4908.174.30Δ | LMR50 | Bridgelux | 600 | 6.6 | 86 | 3000 | >80 | 25.000 | 30° | 350 | € 65,00 |

TECHNICAL INFORMATION

PRODUCT

BASIC 17



- PRODUCT MATERIAL ▶ Die-cast aluminium
- LIGHT SOURCE ▶ QR70 LED / LMR70
- DRIVER ▶ LMR 70 includes a driver
- COLORS (Δ) ▶ ● 3 = RAL 9003 White
- BEAM ANGLE ▶ LMR: 20° / 30°
- ADJUSTABLE ▶ Yes
- SIZE ▶ 170 X 170 X 65/120MM

OPTIONS LMR

- DIMMABLE DRIVER ▶ LMR70 8.5w Dim. 1/10v € 37,00
LMR70 10w Dim. phase-cut € 35,00
- OPTIONAL FRONT RING ▶ LMR70 Aluminium colour. € 3,95
- MOUNTING BRACKET ▶ LMR70 incl. mounting set € 5,00

INFORMATION

LMR including cable, plug, connection cable and driver.

! Only luminaire body, lightsource and/or driver excluded.

Including an assemble plate to mount a single unit into a double, triple, quadruple or "L" shape unit easily in a short time

Keylight International B.V. reserves the right to modify or change technical, construction or LED specifications due to continuous improvements of our products and lightsources.



BASIC 17

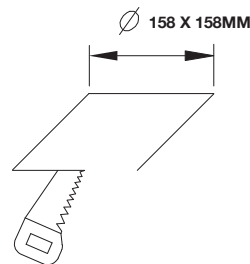

Hole size

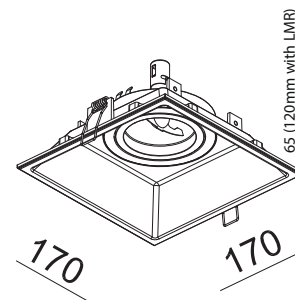

Technical drawing



LMR70

| ARTICLE NO. | LAMP TYPE | BRAND | LIGHT OUTPUT | MODULE POWER | MODULE EFFICIENCY | CORRELATED COLOUR TEMPERATURE | COLOUR RENDERING INDEX | TC LIFE | REFL. | mA | SALES PRICE |
|-----------------------|-----------|-----------|--------------|--------------|-------------------|-------------------------------|------------------------|---------|--------|-----|-------------|
| | | | LM | W | LM/W | K | RA | HRS | DEGREE | mA | EURO |
| ! 4909.99.99.3 | QR70 | | | Max. 50W | | | | | | | € 32,50 |
| 4909.171.20.3 | LMR70 | Bridgelux | 1330 | 15 | 89 | 2700 | >80 | 25.000 | 20° | 350 | € 85,00 |
| 4909.172.30.3 | LMR70 | Bridgelux | 1330 | 15 | 89 | 2700 | >80 | 25.000 | 30° | 350 | € 85,00 |
| 4909.173.20.3 | LMR70 | Bridgelux | 1410 | 15 | 94 | 3000 | >80 | 25.000 | 20° | 350 | € 85,00 |
| 4909.174.30.3 | LMR70 | Bridgelux | 1410 | 15 | 94 | 3000 | >80 | 25.000 | 30° | 350 | € 85,00 |

TECHNICAL INFORMATION

PRODUCT

NITRO 10



- PRODUCT MATERIAL ▶ Die-cast aluminium + steel
- LIGHT SOURCE ▶ MR16 LED / LMR50
- DRIVER ▶ LMR 50 includes a driver
- COLORS (Δ) ▶
 - 3 = RAL 9003 White
 - 5 = RAL 9005 Black
 - 6 = RAL 9006 Alu
- BEAM ANGLE ▶ LMR: 20° / 30°
- ADJUSTABLE ▶ Yes
- SIZE ▶ 106 X 106 X 43/80MM

OPTIONS LMR

- DIMMABLE DRIVER IN COMBINATION WITH NITRO 10 ▶
 - OSRAM 8.5W 1/10v 350mA € 23,50
art. no.: 0110.999.99.0
 - OSRAM 13W phase-cut 350 mA € 23,50
art. no.: 0111.999.99.0
- OPTIONAL FRONT RING ▶ LMR50 Aluminium colour. € 3,95
art. no.: 0052.999.99.6
- MOUNTING BRACKET ▶ LMR50 incl. mounting set € 5,00
art. no.: 0051.999.99.5
- GLASS COVER CLEAR ▶ LMR50 glass IP44 € 3,85
art. no.: 0053.999.99.0

INFORMATION

LMR including cable, plug, connection cable and driver.



Only luminaire body, lightsource and/or driver excluded.

Including an assemble plate to mount a single unit into a double, triple, quadruple or "L" shape unit easily in a short time

Keylight International B.V. reserves the right to modify or change technical, construction or LED specifications due to continuous improvements of our products and lightsources.



BASIC 13

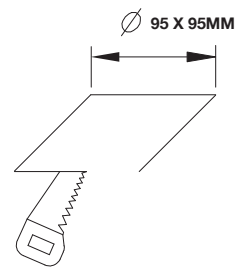

Hole size

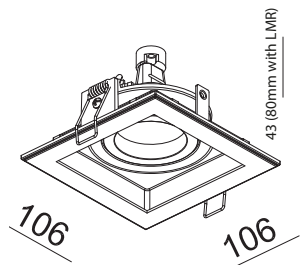

Technical drawing



LMR50

| ARTICLE NO. | LAMP TYPE | BRAND | LIGHT OUTPUT | MODULE POWER | MODULE EFFICIENCY | CORRELATED COLOUR TEMPERATURE | COLOUR RENDERING INDEX | TC LIFE | REFL. | mA | SALES PRICE |
|----------------|-----------|-----------|--------------|--------------|-------------------|-------------------------------|------------------------|---------|--------|-----|-------------|
| Δ see colors | | | LM | W | LM/W | K | RA | HRS | DEGREE | mA | EURO |
| ! 4910.999.99Δ | Gu5.3 | | | Max. 50W | | | | | | | € 23,50 |
| ! 4910.999.99Δ | Gu10 | | | Max. 50W | | | | | | | € 23,50 |
| 4910.171.20Δ | LMR50 | Bridgelux | 560 | 6.6 | 79 | 2700 | >80 | 25.000 | 20° | 350 | € 65,00 |
| 4910.172.30Δ | LMR50 | Bridgelux | 560 | 6.6 | 79 | 2700 | >80 | 25.000 | 30° | 350 | € 65,00 |
| 4910.173.20Δ | LMR50 | Bridgelux | 600 | 6.6 | 86 | 3000 | >80 | 25.000 | 20° | 350 | € 65,00 |
| 4910.174.30Δ | LMR50 | Bridgelux | 600 | 6.6 | 86 | 3000 | >80 | 25.000 | 30° | 350 | € 65,00 |

TECHNICAL INFORMATION

PRODUCT

NITRO 13



- PRODUCT MATERIAL** ▶ Die-cast aluminium
- LIGHT SOURCE** ▶ QR70 LED / LMR70
- DRIVER** ▶ LMR 70 includes a driver
- COLORS (Δ)** ▶
 - 3 = RAL 9003 White
 - 5 = RAL 9005 Black
 - 6 = RAL 9006 Alu
- BEAM ANGLE** ▶ LMR: 20° / 30°
- ADJUSTABLE** ▶ Yes
- SIZE** ▶ 130 X 130 X 145MM

OPTIONS LMR

- DIMMABLE DRIVER** ▶
 - LMR70 8.5w Dim. 1/10v € 37,00
 - LMR70 10w Dim. phase-cut € 35,00
- OPTIONAL FRONT RING** ▶ LMR70 Aluminium colour. € 3,95
- MOUNTING BRACKET** ▶ LMR70 incl. mounting set € 5,00

INFORMATION

LMR including cable, plug, connection cable and driver.

! Only luminaire body, lightsource and/or driver excluded.

Including an assemble plate to mount a single unit into a double, triple, quadruple or "L" shape unit easily in a short time

Keylight International B.V. reserves the right to modify or change technical, construction or LED specifications due to continuous improvements of our products and lightsources.



NITRO 13

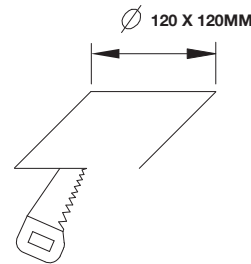

Hole size

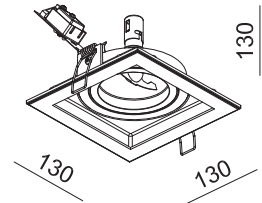

Technical drawing



LMR70

| ARTICLE NO. | LAMP TYPE | BRAND | LIGHT OUTPUT | MODULE POWER | MODULE EFFICIENCY | CORRELATED COLOUR TEMPERATURE | COLOUR RENDERING INDEX | TC LIFE | REFL. | mA | SALES PRICE |
|-----------------------|-----------|-----------|--------------|--------------|-------------------|-------------------------------|------------------------|---------|--------|-----|-------------|
| | | | LM | W | LM/W | K | RA | HRS | DEGREE | mA | EURO |
| ! 4911.99.99.3 | QR70 | | | Max. 50W | | | | | | | € 35,00 |
| 4911.171.20.3 | LMR70 | Bridgelux | 1330 | 15 | 89 | 2700 | >80 | 25.000 | 20° | 350 | € 85,00 |
| 4911.172.30.3 | LMR70 | Bridgelux | 1330 | 15 | 89 | 2700 | >80 | 25.000 | 30° | 350 | € 85,00 |
| 4911.173.20.3 | LMR70 | Bridgelux | 1410 | 15 | 94 | 3000 | >80 | 25.000 | 20° | 350 | € 85,00 |
| 4911.174.30.3 | LMR70 | Bridgelux | 1410 | 15 | 94 | 3000 | >80 | 25.000 | 30° | 350 | € 85,00 |

TECHNICAL INFORMATION

PRODUCT

ORION 11



- PRODUCT MATERIAL** ▶ Aluminium
- LIGHT SOURCE** ▶ DISK G3
- MODULE LIFETIME** ▶ Approx. 50.000 hours
- LED COOLING** ▶ Passive cooling
- DRIVER** ▶ Incl. Integrated driver.
- COLORS (Δ)** ▶
 - 3 = RAL 9003 white
 - 5 = RAL 9005 black
 - 6 = RAL 9006 alu
- BEAM ANGLE** ▶ 80°
- ADJUSTABLE** ▶ No
- SIZE** ▶ 110 X 110 X 105MM

OPTIONS

- COLORS** ▶ Available in all RAL colours on request.
Additional price + 10%
- DIMMABLE** ▶ StandardDimmable leading edge

INFORMATION

- WARRANTY** ▶ 5 Years

Δ = product color code. See colors

Keylight International B.V. reserves the right to modify or change technical, construction or LED specifications due to continuous improvements of our products and lightsources.



ORION 11

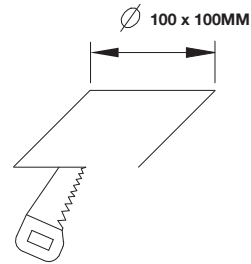

Hole size

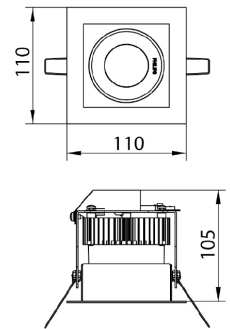

Technical drawing

| ARTICLE NO. | LAMP TYPE | BRAND | LIGHT OUTPUT | MODULE POWER | MODULE EFFICIENCY | CORRELATED COLOUR TEMPERATURE | COLOUR RENDERING INDEX | TC LIFE | POWER FACTOR | SALES PRICE |
|--------------|-----------|---------|--------------|--------------|-------------------|-------------------------------|------------------------|---------|--------------|-------------|
| Δ see colors | | | LM | W | LM/W | K | RA | HRS | PF | EURO |
| 4001.141.85Δ | Disk G3 | Philips | 800 | 12 | 68 | 2700 | >80 | 50.000 | >,09 | € 125,00 |
| 4001.142.85Δ | Disk G3 | Philips | 800 | 12 | 68 | 3000 | >80 | 50.000 | >,09 | € 125,00 |
| 4001.143.85Δ | Disk G3 | Philips | 850 | 11 | 72 | 4000 | >80 | 50.000 | >,09 | € 125,00 |

TECHNICAL INFORMATION

PRODUCT

SQUARE 1



- PRODUCT MATERIAL** ▶ Die-cast aluminium + alu
- LIGHT SOURCE** ▶ MR16 LED / LMR50
- DRIVER** ▶ LMR 50 includes a driver
- COLORS (Δ)** ▶
 - 3 = RAL 9003 white
 - 5 = RAL 9005 black
 - 6 = RAL 9006 alu
- BEAM ANGLE** ▶ LMR: 20° / 30°
- ADJUSTABLE** ▶ Yes
- SIZE** ▶ 125 X 121 X 145MM

OPTIONS LMR

- DIMMABLE DRIVER IN COMBINATION WITH SQUARE 1** ▶
 - OSRAM 8.5W 1/10v 350mA € 23,50
art. no.: 0110.999.99.0
 - OSRAM 13W phase-cut 350 mA € 23,50
art. no.: 0111.999.99.0
- OPTIONAL FRONT RING** ▶ LMR50 Aluminium colour. € 3,95
art. no.: 0052.999.99.6
- MOUNTING BRACKET** ▶ LMR50 incl. mounting set € 5,00
art. no.: 0051.999.99.5
- GLASS COVER CLEAR** ▶ LMR50 glass IP44 € 3,85
art. no.: 0053.999.99.0

INFORMATION

LMR including cable, plug, connection cable and driver.

! Only luminaire body, lightsource and/or driver excluded.

Keylight International B.V. reserves the right to modify or change technical, construction or LED specifications due to continuous improvements of our products and lightsources.



SQUARE 1

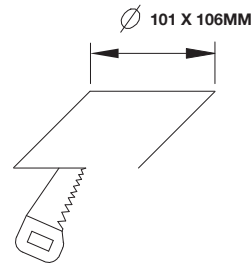

Hole size

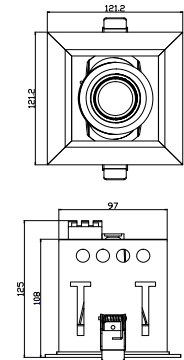

Technical drawing



LMR50

| ARTICLE NO. | LAMP TYPE | BRAND | LIGHT OUTPUT | MODULE POWER | MODULE EFFICIENCY | CORRELATED COLOUR TEMPERATURE | COLOUR RENDERING INDEX | TC LIFE | REFL. | mA | SALES PRICE |
|-----------------------|-----------|-----------|--------------|--------------|-------------------|-------------------------------|------------------------|---------|--------|-----|-------------|
| Δ see colors | | | LM | W | LM/W | K | RA | HRS | DEGREE | mA | EURO |
| ! 4520.999.99Δ | Gu5.3 | | | Max. 50W | | | | | | | € 30,00 |
| ! 4520.999.99Δ | Gu10 | | | Max. 50W | | | | | | | € 30,00 |
| 4520.171.20Δ | LMR50 | Bridgelux | 560 | 6.6 | 79 | 2700 | >80 | 25.000 | 20° | 350 | € 70,00 |
| 4520.172.30Δ | LMR50 | Bridgelux | 560 | 6.6 | 79 | 2700 | >80 | 25.000 | 30° | 350 | € 70,00 |
| 4520.173.20Δ | LMR50 | Bridgelux | 600 | 6.6 | 86 | 3000 | >80 | 25.000 | 20° | 350 | € 70,00 |
| 4520.174.30Δ | LMR50 | Bridgelux | 600 | 6.6 | 86 | 3000 | >80 | 25.000 | 30° | 350 | € 70,00 |

TECHNICAL INFORMATION

PRODUCT

SQUARE 2



- PRODUCT MATERIAL** ▶ Die-cast aluminium + alu
- LIGHT SOURCE** ▶ MR16 LED / LMR50
- DRIVER** ▶ LMR 50 includes a driver
- COLORS (Δ)** ▶
 - 3 = RAL 9003 white
 - 5 = RAL 9005 black
 - 6 = RAL 9006 alu
- BEAM ANGLE** ▶ LMR: 20° / 30°
- ADJUSTABLE** ▶ Yes
- SIZE** ▶ 196 X 122 X 145MM

OPTIONS LMR

- DIMMABLE DRIVER (2X) IN COMBINATION WITH SQUARE 2** ▶
 - OSRAM 8,5W 1/10v 350mA € 23,50
art. no.: 0110.999.99.0
 - OSRAM 13W phase-cut 350 mA € 23,50
art. no.: 0111.999.99.0
- OPTIONAL FRONT RING** ▶ LMR50 Aluminium colour. € 7,90
2x art. no.: 0052.999.99.6
- MOUNTING BRACKET** ▶ LMR50 incl. mounting set € 10,00
2x art. no.: 0051.999.99.5
- GLASS COVER CLEAR** ▶ LMR50 glass IP44 € 7,70
2x art. no.: 0053.999.99.0

INFORMATION

LMR including cable, plug, connection cable and driver.

! Only luminaire body, lightsource and/or driver excluded.

Keylight International B.V. reserves the right to modify or change technical, construction or LED specifications due to continuous improvements of our products and lightsources.



SQUARE 2

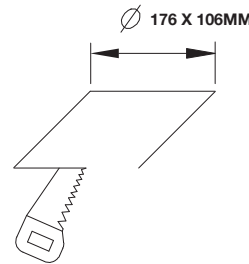

Hole size

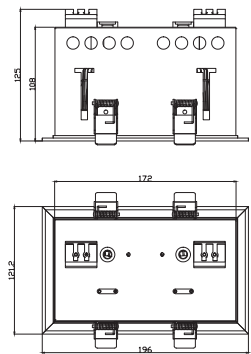

Technical drawing



LMR50

| ARTICLE NO. | LAMP TYPE | BRAND | LIGHT OUTPUT | MODULE POWER | MODULE EFFICIENCY | CORRELATED COLOUR TEMPERATURE | COLOUR RENDERING INDEX | TC LIFE | REFL. | mA | SALES PRICE |
|-----------------------|-----------|-----------|--------------|--------------|-------------------|-------------------------------|------------------------|---------|--------|-----|-------------|
| Δ see colors | | | LM | W | LM/W | K | RA | HRS | DEGREE | mA | EURO |
| ! 4521.999.99Δ | Gu5.3 | | | Max. 50W | | | | | | | € 60,00 |
| ! 4521.999.99Δ | Gu10 | | | Max. 50W | | | | | | | € 60,00 |
| 4521.171.20Δ | LMR50 | Bridgelux | 2 X 560 | 2 X 6.6 | 79 | 2700 | >80 | 25.000 | 20° | 350 | € 140,00 |
| 4521.172.30Δ | LMR50 | Bridgelux | 2 X 560 | 2 X 6.6 | 79 | 2700 | >80 | 25.000 | 30° | 350 | € 140,00 |
| 4521.173.20Δ | LMR50 | Bridgelux | 2 X 600 | 2 X 6.6 | 86 | 3000 | >80 | 25.000 | 20° | 350 | € 140,00 |
| 4521.174.30Δ | LMR50 | Bridgelux | 2 X 600 | 2 X 6.6 | 86 | 3000 | >80 | 25.000 | 30° | 350 | € 140,00 |

TECHNICAL INFORMATION

PRODUCT

MONACO 16



- PRODUCT MATERIAL** ▶ Steel and Aluminium
- LIGHT SOURCE** ▶ Philips DLM-S
- MODULE LIFETIME** ▶ Approx. 30.000 hours
- LED COOLING** ▶ Passive cooling
- DRIVER** ▶ Incl. Intergrated Driver
- COLORS Δ** ▶
 - 3 = RAL 9003 white
 - 5 = RAL 9005 black
 - 6 = RAL 9006 alu
- BEAM ANGLE** ▶ 80°
- REFLECTOR** ▶ Glossy
- ADJUSTABLE** ▶ No
- SIZE** ▶ 152 X 152 X 75MM

OPTIONS

- REFLECTOR** ▶ White reflector on request.
- COLORS** ▶ Available in all RAL colours on request.
Additional price + 10%

INFORMATION

- WARRANTY** ▶ 2 Years

This luminaire is "plug & play".

Incl. cable and plug.

Keylight International B.V. reserves the right to modify or change technical, construction or LED specifications due to continuous improvements of our products and lightsources.



MONACO 16

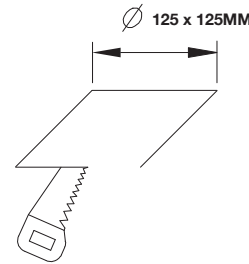

Hole size

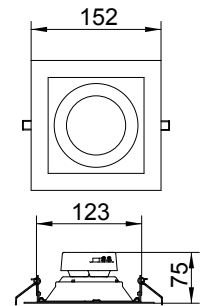

Technical drawing

| ARTICLE NO. | LAMP TYPE | BRAND | LIGHT OUTPUT | MODULE POWER | MODULE EFFICIENCY | CORRELATED COLOUR TEMPERATURE | COLOUR RENDERING INDEX | TC LIFE | POWER FACTOR | SALES PRICE |
|---------------|-----------|---------|--------------|--------------|-------------------|-------------------------------|------------------------|---------|--------------|-------------|
| Δ see colors | | | LM | W | LM/W | K | RA | HRS | PF | EURO |
| 4074.130.80.Δ | DLM-S | Philips | 1000 | 13 | 77 | 3000 | >80 | 30.000 | >09, | € 90,00 |
| 4074.140.80.Δ | DLM-S | Philips | 1000 | 13 | 77 | 4000 | >80 | 30.000 | >09, | € 90,00 |

TECHNICAL INFORMATION

PRODUCT

MONACO 18



- PRODUCT MATERIAL** ▶ Steel and Aluminium
- LIGHT SOURCE** ▶ Philips DLM-S
- MODULE LIFETIME** ▶ Approx. 30.000 hours
- LED COOLING** ▶ Passive cooling
- DRIVER** ▶ Incl. Intergrated Driver
- COLORS Δ** ▶
 - 3 = RAL 9003 white
 - 5 = RAL 9005 black
 - 6 = RAL 9006 alu
- BEAM ANGLE** ▶ 80°
- REFLECTOR** ▶ Glossy
- ADJUSTABLE** ▶ No
- SIZE** ▶ 214 X 214 X 84MM

OPTIONS

- REFLECTOR** ▶ White reflector on request.
- COLORS** ▶ Available in all RAL colours on request.
Additional price + 10%

INFORMATION

- WARRANTY** ▶ 2 Years

This luminaire is "plug & play".

Incl. cable and plug.

Keylight International B.V. reserves the right to modify or change technical, construction or LED specifications due to continuous improvements of our products and lightsources.



MONACO 18

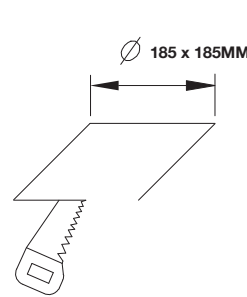

Hole size

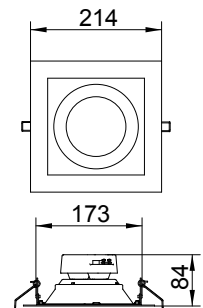

Technical drawing

| ARTICLE NO. | LAMP TYPE | BRAND | LIGHT OUTPUT | MODULE POWER | MODULE EFFICIENCY | CORRELATED COLOUR TEMPERATURE | COLOUR RENDERING INDEX | TC LIFE | POWER FACTOR | SALES PRICE |
|---------------|-----------|---------|--------------|--------------|-------------------|-------------------------------|------------------------|---------|--------------|-------------|
| Δ see colors | | | LM | W | LM/W | K | RA | HRS | PF | EURO |
| 4075.130.80.Δ | DLM-S | Philips | 2000 | 26 | 70 | 3000 | >80 | 30.000 | >09, | € 110,00 |
| 4075.140.80.Δ | DLM-S | Philips | 2000 | 26 | 70 | 4000 | >80 | 30.000 | >09, | € 110,00 |

TECHNICAL INFORMATION

PRODUCT

THUNDER 1



- PRODUCT MATERIAL** ▶ Die-cast aluminium
- LIGHT SOURCE** ▶ SLM G4
- MODULE LIFETIME** ▶ Approx. 50.000 hours
- LED COOLING** ▶ Passive cooling
- DRIVER** ▶ Incl. Xitanium driver.
- COLORS (Δ)** ▶
 - 3 = RAL 9003 white
 - 5 = RAL 9005 black
 - 6 = RAL 9006 alu
- BEAM ANGLE** ▶ 24°
- ADJUSTABLE** ▶ Yes
- SIZE** ▶ 163 X 163 X 135MM

OPTIONS

- EMERGENCY BALLAST** ▶ 0187.999.99 1 - 3 hours. € 275,00
- DIFFUSER** ▶ 0186.999.99 € 9,50
- DIFFUSER W/ HOLE** ▶ 0188.999.99 € 9,50
- DIMMABLE** ▶ Dimmable DALI € 45,00
- OPTIONAL BEAM ANGLE** ▶ 36° € 5,00

INFORMATION

- WARRANTY** ▶ 5 Years

Δ = product color code. See colors

including cable and plug.

Keylight International B.V. reserves the right to modify or change technical, construction or LED specifications due to continuous improvements of our products and lightsources.



THUNDER 1

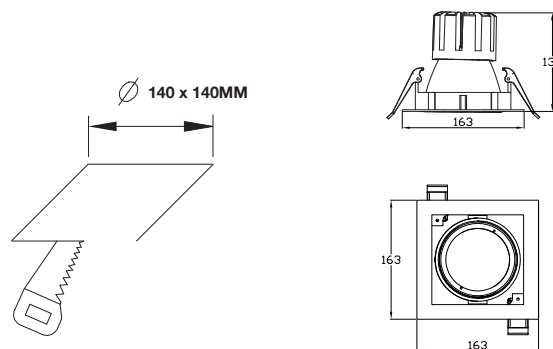

Hole size

Technical drawing

| ARTICLE NO. | LAMP TYPE | BRAND | LIGHT OUTPUT | MODULE POWER | SETTING | MODULE EFFICIENCY | CORRELATED COLOUR TEMPERATURE | COLOUR RENDERING INDEX | B50/L70 AT TC LIFE | SALES PRICE |
|--------------|---------------------|---------|--------------|--------------|------------------|-------------------|-------------------------------|------------------------|--------------------|-------------|
| Δ see colors | GEN 4 | | LM | W | | LM/W | K | RA | HRS | EURO |
| 4391.111.30Δ | SLM 1100-827 L13 # | Philips | 1160 | 10 | High Efficiency | 114 | 2700 | >82 | 50.000 | € 145,00 |
| 4391.112.30Δ | SLM 1100-830 L13 | Philips | 1240 | 10 | High Efficiency | 122 | 3000 | >82 | 50.000 | € 145,00 |
| 4391.113.30Δ | SLM 1100-840 L13 | Philips | 1330 | 10 | High Efficiency | 130 | 4000 | >82 | 50.000 | € 145,00 |
| 4391.114.30Δ | SLM 2000-830 L13 | Philips | 2020 | 17 | High Efficiency | 117 | 3000 | >82 | 50.000 | € 155,00 |
| 4391.116.30Δ | SLM 2000-840 L13 | Philips | 2150 | 17 | High Efficiency | 124 | 4000 | >82 | 50.000 | € 155,00 |
| 4391.125.30Δ | SLM 2000-927 L13 # | Philips | 1570 | 17 | High Efficiency | 91 | 2700 | >97 | 50.000 | € 160,00 |
| 4391.120.30Δ | SLM 2000-930 L13 | Philips | 1650 | 17 | High Efficiency | 95 | 3000 | >97 | 50.000 | € 160,00 |
| 4391.117.30Δ | SLM 3000-830 L15 | Philips | 2970 | 26 | High Efficiency | 114 | 3000 | >82 | 50.000 | € 165,00 |
| 4391.119.30Δ | SLM 3000-840 L15 | Philips | 3170 | 26 | High Efficiency | 122 | 4000 | >82 | 50.000 | € 165,00 |
| 4391.128.30Δ | SLM 3000-927 L15 # | Philips | 2320 | 26 | High Efficiency | 89 | 2700 | >97 | 50.000 | € 170,00 |
| 4391.121.30Δ | SLM 3000-930 L15 | Philips | 2400 | 26 | High Efficiency | 92 | 3000 | >97 | 50.000 | € 170,00 |
| 4391.135.30Δ | SLM 4500-830 L19 | Philips | 4860 | 42 | High Efficiency | 114 | 3000 | >82 | 50.000 | € 205,00 |
| 4391.136.30Δ | SLM 4500-840 L19 | Philips | 5160 | 42 | High Efficiency | 122 | 4000 | >82 | 50.000 | € 205,00 |
| 4391.157.30Δ | SLM 4500-927 L19 | Philips | 3760 | 42 | High Efficiency | 89 | 2700 | >97 | 50.000 | € 210,00 |
| 4391.137.30Δ | SLM 4500-930 L19 | Philips | 3930 | 42 | High Efficiency | 92 | 3000 | >97 | 50.000 | € 210,00 |
| 4391.109.30Δ | SLM CW 3000-930 L15 | Philips | 2790 | 34 | Crisp White | 82 | 3000 | >92 | 50.000 | € 195,00 |
| 4391.110.30Δ | SLM CW 3800-930 L19 | Philips | 2790 | 34 | Crisp White | 82 | 3000 | >92 | 50.000 | € 235,00 |
| 4391.159.30Δ | SLM FW 2800-925 L19 | Philips | 2880 | 42 | Food Warm White | 69 | 2900 | >90 | 50.000 | € 240,00 |
| 4391.160.30Δ | SLM FR 3000-930 L19 | Philips | 2980 | 42 | Food Premium red | 72 | 3150 | >87 | 50.000 | € 240,00 |

* SLM G4: High efficacy is Keylight standard. High value: option for more Lumen flux output (more power, more watt) option on request.
 # SLM 827 + 927. On special request
 - SLM Premium White (colour point bBBL) 2000 Lm / 4500 Lm 3000k, On special request

TECHNICAL INFORMATION

PRODUCT

THUNDER 2



- PRODUCT MATERIAL** ▶ Die-cast aluminium
- LIGHT SOURCE** ▶ SLM G4
- MODULE LIFETIME** ▶ Approx. 50.000 hours
- LED COOLING** ▶ Passive cooling
- DRIVER** ▶ Incl. Xitanium driver.
- COLORS (Δ)** ▶
 - 3 = RAL 9003 white
 - 5 = RAL 9005 black
 - 6 = RAL 9006 alu
- BEAM ANGLE** ▶ 24°
- ADJUSTABLE** ▶ Yes
- SIZE** ▶ 326 X 163 X 136MM

OPTIONS

- EMERGENCY BALLAST** ▶ 1x 0187.999.99 1 - 3 hours. € 270,00
- DIFFUSER** ▶ 2x 0186.999.99 € 19,00
- DIFFUSER W/ HOLE** ▶ 2x 0188.999.99 € 19,00
- DIMMABLE** ▶ Dimmable DALI € 80,00
- OPTIONAL BEAM ANGLE** ▶ 36° € 10,00

INFORMATION

WARRANTY ▶ 5 Years

Δ = product color code. See colors

including cable and plug.

Keylight International B.V. reserves the right to modify or change technical, construction or LED specifications due to continuous improvements of our products and lightsources.



THUNDER 2

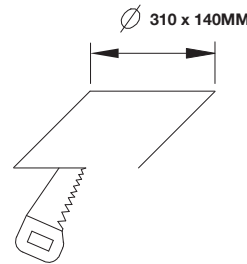

Hole size

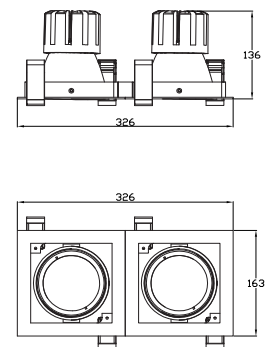

Technical drawing

| ARTICLE NO. | LAMP TYPE | BRAND | LIGHT OUTPUT | MODULE POWER | SETTING | MODULE EFFICIENCY | CORRELATED COLOUR TEMPERATURE | COLOUR RENDERING INDEX | B50/L70 AT TC LIFE | SALES PRICE |
|--------------|---------------------|---------|--------------|--------------|------------------|-------------------|-------------------------------|------------------------|--------------------|-------------|
| Δ see colors | GEN 4 | | LM | W | | LM/W | K | RA | HRS | EURO |
| 4392.111.30Δ | SLM 1100-827 L13 # | Philips | 1160 | 10 | High Efficiency | 114 | 2700 | >82 | 50.000 | € 290,00 |
| 4392.112.30Δ | SLM 1100-830 L13 | Philips | 1240 | 10 | High Efficiency | 122 | 3000 | >82 | 50.000 | € 290,00 |
| 4392.113.30Δ | SLM 1100-840 L13 | Philips | 1330 | 10 | High Efficiency | 130 | 4000 | >82 | 50.000 | € 290,00 |
| 4392.114.30Δ | SLM 2000-830 L13 | Philips | 2020 | 17 | High Efficiency | 117 | 3000 | >82 | 50.000 | € 310,00 |
| 4392.116.30Δ | SLM 2000-840 L13 | Philips | 2150 | 17 | High Efficiency | 124 | 4000 | >82 | 50.000 | € 310,00 |
| 4392.125.30Δ | SLM 2000-927 L13 # | Philips | 1570 | 17 | High Efficiency | 91 | 2700 | >97 | 50.000 | € 315,00 |
| 4392.120.30Δ | SLM 2000-930 L13 | Philips | 1650 | 17 | High Efficiency | 95 | 3000 | >97 | 50.000 | € 315,00 |
| 4392.117.30Δ | SLM 3000-830 L15 | Philips | 2970 | 26 | High Efficiency | 114 | 3000 | >82 | 50.000 | € 330,00 |
| 4392.119.30Δ | SLM 3000-840 L15 | Philips | 3170 | 26 | High Efficiency | 122 | 4000 | >82 | 50.000 | € 330,00 |
| 4392.128.30Δ | SLM 3000-927 L15 # | Philips | 2320 | 26 | High Efficiency | 89 | 2700 | >97 | 50.000 | € 335,00 |
| 4392.121.30Δ | SLM 3000-930 L15 | Philips | 2400 | 26 | High Efficiency | 92 | 3000 | >97 | 50.000 | € 335,00 |
| 4392.135.24Δ | SLM 4500-830 L19 | Philips | 4860 | 42 | High Efficiency | 114 | 3000 | >82 | 50.000 | € 410,00 |
| 4392.136.24Δ | SLM 4500-840 L19 | Philips | 5160 | 42 | High Efficiency | 122 | 4000 | >82 | 50.000 | € 410,00 |
| 4392.157.24Δ | SLM 4500-927 L19 | Philips | 3760 | 42 | High Efficiency | 89 | 2700 | >97 | 50.000 | € 220,00 |
| 4392.137.24Δ | SLM 4500-930 L19 | Philips | 3930 | 42 | High Efficiency | 92 | 3000 | >97 | 50.000 | € 220,00 |
| 4392.109.30Δ | SLM CW 3000-930 L15 | Philips | 2790 | 34 | Crisp White | 82 | 3000 | >92 | 50.000 | € 390,00 |
| 4392.110.30Δ | SLM CW 3800-930 L19 | Philips | 2790 | 34 | Crisp White | 82 | 3000 | >92 | 50.000 | € 470,00 |
| 4392.159.30Δ | SLM FW 2800-925 L19 | Philips | 2880 | 42 | Food Warm White | 69 | 2900 | >90 | 50.000 | € 480,00 |
| 4392.160.30Δ | SLM FR 3000-930 L19 | Philips | 2980 | 42 | Food Premium red | 72 | 3150 | >87 | 50.000 | € 480,00 |

* SLM G4: High efficacy is Keylight standard. High value: option for more Lumen flux output (more power, more watt) option on request.
 # SLM 827 + 927. On special request
 - SLM Premium White (colour point bBBL) 2000 Lm / 4500 Lm 3000k, On special request

TECHNICAL INFORMATION

PRODUCT

THUNDER 3



- PRODUCT MATERIAL** ▶ Die-cast aluminium
- LIGHT SOURCE** ▶ SLM G4
- MODULE LIFETIME** ▶ Approx. 50.000 hours
- LED COOLING** ▶ Passive cooling
- DRIVER** ▶ Incl. Xitanium driver.
- COLORS (Δ)** ▶
 - 3 = RAL 9003 white
 - 5 = RAL 9005 black
 - 6 = RAL 9006 alu
- BEAM ANGLE** ▶ 24°
- ADJUSTABLE** ▶ Yes
- SIZE** ▶ 489 X 163 X 136MM

OPTIONS

- EMERGENCY BALLAST** ▶ 1x 0187.999.99 1 - 3 hours. € 270,00
- DIFFUSER** ▶ 3x 0186.999.99 € 28,50
- DIFFUSER W/ HOLE** ▶ 3x 0188.999.99 € 28,50
- DIMMABLE** ▶ Dimmable DALI € 135,00
- OPTIONAL BEAM ANGLE** ▶ 36° € 15,00

INFORMATION

- WARRANTY** ▶ 5 Years

Δ = product color code. See colors

including cable and plug.

Keylight International B.V. reserves the right to modify or change technical, construction or LED specifications due to continuous improvements of our products and lightsources.



THUNDER 3

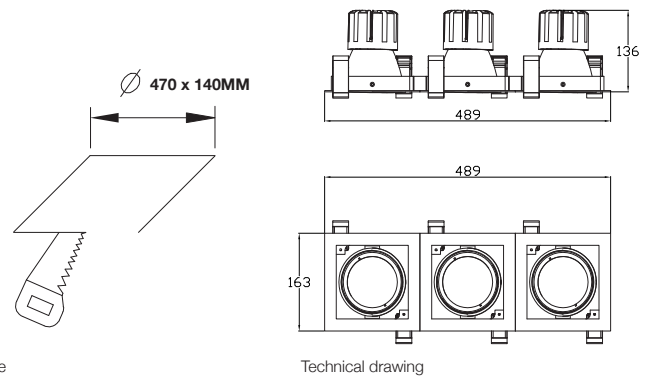

Hole size

Technical drawing

| ARTICLE NO. | LAMP TYPE | BRAND | LIGHT OUTPUT | MODULE POWER | SETTING | MODULE EFFICIENCY | CORRELATED COLOUR TEMPERATURE | COLOUR RENDERING INDEX | B50/L70 AT TC LIFE | SALES PRICE |
|--------------|---------------------|---------|--------------|--------------|------------------|-------------------|-------------------------------|------------------------|--------------------|-------------|
| Δ see colors | GEN 4 | | LM | W | | LM/W | K | RA | HRS | EURO |
| 4393.111.30Δ | SLM 1100-827 L13 # | Philips | 1160 | 10 | High Efficiency | 114 | 2700 | >82 | 50.000 | € 435,00 |
| 4393.112.30Δ | SLM 1100-830 L13 | Philips | 1240 | 10 | High Efficiency | 122 | 3000 | >82 | 50.000 | € 435,00 |
| 4393.113.30Δ | SLM 1100-840 L13 | Philips | 1330 | 10 | High Efficiency | 130 | 4000 | >82 | 50.000 | € 435,00 |
| 4393.114.30Δ | SLM 2000-830 L13 | Philips | 2020 | 17 | High Efficiency | 117 | 3000 | >82 | 50.000 | € 465,00 |
| 4393.116.30Δ | SLM 2000-840 L13 | Philips | 2150 | 17 | High Efficiency | 124 | 4000 | >82 | 50.000 | € 465,00 |
| 4393.125.30Δ | SLM 2000-927 L13 # | Philips | 1570 | 17 | High Efficiency | 91 | 2700 | >97 | 50.000 | € 470,00 |
| 4393.120.30Δ | SLM 2000-930 L13 | Philips | 1650 | 17 | High Efficiency | 95 | 3000 | >97 | 50.000 | € 470,00 |
| 4393.117.30Δ | SLM 3000-830 L15 | Philips | 2970 | 26 | High Efficiency | 114 | 3000 | >82 | 50.000 | € 495,00 |
| 4393.119.30Δ | SLM 3000-840 L15 | Philips | 3170 | 26 | High Efficiency | 122 | 4000 | >82 | 50.000 | € 495,00 |
| 4393.128.30Δ | SLM 3000-927 L15 # | Philips | 2320 | 26 | High Efficiency | 89 | 2700 | >97 | 50.000 | € 510,00 |
| 4393.121.30Δ | SLM 3000-930 L15 | Philips | 2400 | 26 | High Efficiency | 92 | 3000 | >97 | 50.000 | € 510,00 |
| 4393.135.24Δ | SLM 4500-830 L19 | Philips | 4860 | 42 | High Efficiency | 114 | 3000 | >82 | 50.000 | € 615,00 |
| 4393.136.24Δ | SLM 4500-840 L19 | Philips | 5160 | 42 | High Efficiency | 122 | 4000 | >82 | 50.000 | € 615,00 |
| 4393.157.24Δ | SLM 4500-927 L19 | Philips | 3760 | 42 | High Efficiency | 89 | 2700 | >97 | 50.000 | € 630,00 |
| 4393.137.24Δ | SLM 4500-930 L19 | Philips | 3930 | 42 | High Efficiency | 92 | 3000 | >97 | 50.000 | € 630,00 |
| 4393.109.30Δ | SLM CW 3000-930 L15 | Philips | 2790 | 34 | Crisp White | 82 | 3000 | >92 | 50.000 | € 585,00 |
| 4393.110.30Δ | SLM CW 3800-930 L19 | Philips | 2790 | 34 | Crisp White | 82 | 3000 | >92 | 50.000 | € 695,00 |
| 4393.159.30Δ | SLM FW 2800-925 L19 | Philips | 2880 | 42 | Food Warm White | 69 | 2900 | >90 | 50.000 | € 720,00 |
| 4393.160.30Δ | SLM FR 3000-930 L19 | Philips | 2980 | 42 | Food Premium red | 72 | 3150 | >87 | 50.000 | € 720,00 |

* SLM G4: High efficacy is Keylight standard. High value: option for more Lumen flux output (more power, more watt) option on request.
 # SLM 827 + 927. On special request
 - SLM Premium White (colour point bBBL) 2000 Lm / 4500 Lm 3000k, On special request

TECHNICAL INFORMATION

PRODUCT

LUXX 1



- PRODUCT MATERIAL** ▶ Die-cast aluminium
- LIGHT SOURCE** ▶ SLM G4
- MODULE LIFETIME** ▶ Approx. 50.000 hours
- LED COOLING** ▶ Passive cooling
- DRIVER** ▶ Incl. Xitanium driver.
- COLORS (Δ)** ▶
 - 3 = RAL 9003 white
 - 5 = RAL 9005 black
 - 6 = RAL 9006 alu
- BEAM ANGLE** ▶ 24°
- ADJUSTABLE** ▶ Yes
- SIZE** ▶ 190 X 200 X 163MM

OPTIONS

- EMERGENCY BALLAST** ▶ 0187.999.99 1 - 3 hours. € 270,00
- DIFFUSER** ▶ 0183.999.99 € 9,50
- DIFFUSER W/ HOLE** ▶ 0189.999.99 € 9,50
- DIMMABLE** ▶ Dimmable DALI € 45,00
- OPTIONAL BEAM ANGLE** ▶ 36° € 5,00

INFORMATION

WARRANTY ▶ 5 Years

Δ = product color code. See colors

including cable and plug.

Keylight International B.V. reserves the right to modify or change technical, construction or LED specifications due to continuous improvements of our products and light sources.



LUXX 1

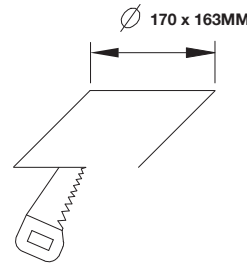

Hole size

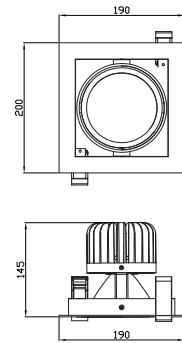

Technical drawing

| ARTICLE NO. | LAMP TYPE | BRAND | LIGHT OUTPUT | MODULE POWER | SETTING | MODULE EFFICIENCY | CORRELATED COLOUR TEMPERATURE | COLOUR RENDERING INDEX | B50/L70 AT TC LIFE | SALES PRICE |
|--------------|---------------------|---------|--------------|--------------|------------------|-------------------|-------------------------------|------------------------|--------------------|-------------|
| Δ see colors | GEN 4 | | LM | W | | LM/W | K | RA | HRS | EURO |
| 4394.111.30Δ | SLM 1100-827 L13 # | Philips | 1160 | 10 | High Efficiency | 114 | 2700 | >82 | 50.000 | € 155,00 |
| 4394.112.30Δ | SLM 1100-830 L13 | Philips | 1240 | 10 | High Efficiency | 122 | 3000 | >82 | 50.000 | € 155,00 |
| 4394.113.30Δ | SLM 1100-840 L13 | Philips | 1330 | 10 | High Efficiency | 130 | 4000 | >82 | 50.000 | € 155,00 |
| 4394.114.30Δ | SLM 2000-830 L13 | Philips | 2020 | 17 | High Efficiency | 117 | 3000 | >82 | 50.000 | € 165,00 |
| 4394.116.30Δ | SLM 2000-840 L13 | Philips | 2150 | 17 | High Efficiency | 124 | 4000 | >82 | 50.000 | € 165,00 |
| 4394.125.30Δ | SLM 2000-927 L13 # | Philips | 1570 | 17 | High Efficiency | 91 | 2700 | >97 | 50.000 | € 170,00 |
| 4394.120.30Δ | SLM 2000-930 L13 | Philips | 1650 | 17 | High Efficiency | 95 | 3000 | >97 | 50.000 | € 170,00 |
| 4394.117.30Δ | SLM 3000-830 L15 | Philips | 2970 | 26 | High Efficiency | 114 | 3000 | >82 | 50.000 | € 175,00 |
| 4394.119.30Δ | SLM 3000-840 L15 | Philips | 3170 | 26 | High Efficiency | 122 | 4000 | >82 | 50.000 | € 175,00 |
| 4394.128.30Δ | SLM 3000-927 L15 # | Philips | 2320 | 26 | High Efficiency | 89 | 2700 | >97 | 50.000 | € 180,00 |
| 4394.121.30Δ | SLM 3000-930 L15 | Philips | 2400 | 26 | High Efficiency | 92 | 3000 | >97 | 50.000 | € 180,00 |
| 4394.135.24Δ | SLM 4500-830 L19 | Philips | 4860 | 42 | High Efficiency | 114 | 3000 | >82 | 50.000 | € 215,00 |
| 4394.136.24Δ | SLM 4500-840 L19 | Philips | 5160 | 42 | High Efficiency | 122 | 4000 | >82 | 50.000 | € 215,00 |
| 4394.157.24Δ | SLM 4500-927 L19 | Philips | 3760 | 42 | High Efficiency | 89 | 2700 | >97 | 50.000 | € 220,00 |
| 4394.137.24Δ | SLM 4500-930 L19 | Philips | 3930 | 42 | High Efficiency | 92 | 3000 | >97 | 50.000 | € 220,00 |
| 4394.109.30Δ | SLM CW 3000-930 L15 | Philips | 2790 | 34 | Crisp White | 82 | 3000 | >92 | 50.000 | € 210,00 |
| 4394.110.30Δ | SLM CW 3800-930 L19 | Philips | 2790 | 34 | Crisp White | 82 | 3000 | >92 | 50.000 | € 250,00 |
| 4394.159.30Δ | SLM FW 2800-925 L19 | Philips | 2880 | 42 | Food Warm White | 69 | 2900 | >90 | 50.000 | € 260,00 |
| 4394.160.30Δ | SLM FR 3000-930 L19 | Philips | 2980 | 42 | Food Premium red | 72 | 3150 | >87 | 50.000 | € 260,00 |

* SLM G4: High efficacy is Keylight standard. High value: option for more Lumen flux output (more power, more watt) option on request.
 # SLM 827 + 927. On special request
 - SLM Premium White (colour point bBBL) 2000 Lm / 4500 Lm 3000k, On special request

TECHNICAL INFORMATION

PRODUCT

LUXX 2



- PRODUCT MATERIAL** ▶ Die-cast aluminium
- LIGHT SOURCE** ▶ SLM G4
- MODULE LIFETIME** ▶ Approx. 50.000 hours
- LED COOLING** ▶ Passive cooling
- DRIVER** ▶ Incl. Xitanium driver.
- COLORS (Δ)** ▶
 - 3 = RAL 9003 white
 - 5 = RAL 9005 black
 - 6 = RAL 9006 alu
- BEAM ANGLE** ▶ 24°
- ADJUSTABLE** ▶ Yes
- SIZE** ▶ 380 X 145 X 200MM

OPTIONS

- EMERGENCY BALLAST** ▶ 1x 0187.999.99 1 - 3 hours. € 270,00
- DIFFUSER** ▶ 2x 0183.999.99 € 19,00
- DIFFUSER W/ HOLE** ▶ 2x 0189.999.99 € 19,00
- DIMMABLE** ▶ Dimmable DALI € 90,00
- OPTIONAL BEAM ANGLE** ▶ 36° € 5,00

INFORMATION

- WARRANTY** ▶ 5 Years

Δ = product color code. See colors

including cable and plug.

Keylight International B.V. reserves the right to modify or change technical, construction or LED specifications due to continuous improvements of our products and lightsources.



LUXX 2

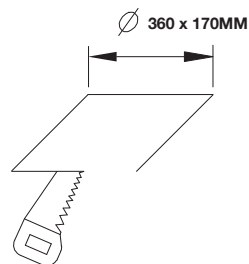

Hole size

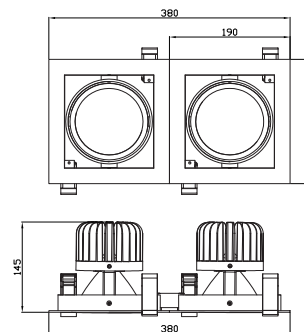

Technical drawing

| ARTICLE NO. | LAMP TYPE | BRAND | LIGHT OUTPUT | MODULE POWER | SETTING | MODULE EFFICIENCY | CORRELATED COLOUR TEMPERATURE | COLOUR RENDERING INDEX | B50/L70 AT TC LIFE | SALES PRICE |
|--------------|---------------------|---------|--------------|--------------|------------------|-------------------|-------------------------------|------------------------|--------------------|-------------|
| Δ see colors | GEN 4 | | LM | W | | LM/W | K | RA | HRS | EURO |
| 4395.111.30Δ | SLM 1100-827 L13 # | Philips | 1160 | 10 | High Efficiency | 114 | 2700 | >82 | 50.000 | € 310,00 |
| 4395.112.30Δ | SLM 1100-830 L13 | Philips | 1240 | 10 | High Efficiency | 122 | 3000 | >82 | 50.000 | € 310,00 |
| 4395.113.30Δ | SLM 1100-840 L13 | Philips | 1330 | 10 | High Efficiency | 130 | 4000 | >82 | 50.000 | € 310,00 |
| 4395.114.30Δ | SLM 2000-830 L13 | Philips | 2020 | 17 | High Efficiency | 117 | 3000 | >82 | 50.000 | € 330,00 |
| 4395.116.30Δ | SLM 2000-840 L13 | Philips | 2150 | 17 | High Efficiency | 124 | 4000 | >82 | 50.000 | € 330,00 |
| 4395.125.30Δ | SLM 2000-927 L13 # | Philips | 1570 | 17 | High Efficiency | 91 | 2700 | >97 | 50.000 | € 335,00 |
| 4395.120.30Δ | SLM 2000-930 L13 | Philips | 1650 | 17 | High Efficiency | 95 | 3000 | >97 | 50.000 | € 335,00 |
| 4395.117.30Δ | SLM 3000-830 L15 | Philips | 2970 | 26 | High Efficiency | 114 | 3000 | >82 | 50.000 | € 350,00 |
| 4395.119.30Δ | SLM 3000-840 L15 | Philips | 3170 | 26 | High Efficiency | 122 | 4000 | >82 | 50.000 | € 350,00 |
| 4395.128.30Δ | SLM 3000-927 L15 # | Philips | 2320 | 26 | High Efficiency | 89 | 2700 | >97 | 50.000 | € 355,00 |
| 4395.121.30Δ | SLM 3000-930 L15 | Philips | 2400 | 26 | High Efficiency | 92 | 3000 | >97 | 50.000 | € 355,00 |
| 4395.135.24Δ | SLM 4500-830 L19 | Philips | 4860 | 42 | High Efficiency | 114 | 3000 | >82 | 50.000 | € 430,00 |
| 4395.136.24Δ | SLM 4500-840 L19 | Philips | 5160 | 42 | High Efficiency | 122 | 4000 | >82 | 50.000 | € 430,00 |
| 4395.157.24Δ | SLM 4500-927 L19 | Philips | 3760 | 42 | High Efficiency | 89 | 2700 | >97 | 50.000 | € 440,00 |
| 4395.137.24Δ | SLM 4500-930 L19 | Philips | 3930 | 42 | High Efficiency | 92 | 3000 | >97 | 50.000 | € 440,00 |
| 4395.109.30Δ | SLM CW 3000-930 L15 | Philips | 2790 | 34 | Crisp White | 82 | 3000 | >92 | 50.000 | € 420,00 |
| 4395.110.30Δ | SLM CW 3800-930 L19 | Philips | 2790 | 34 | Crisp White | 82 | 3000 | >92 | 50.000 | € 500,00 |
| 4395.159.30Δ | SLM FW 2800-925 L19 | Philips | 2880 | 42 | Food Warm White | 69 | 2900 | >90 | 50.000 | € 520,00 |
| 4395.160.30Δ | SLM FR 3000-930 L19 | Philips | 2980 | 42 | Food Premium red | 72 | 3150 | >87 | 50.000 | € 520,00 |

* SLM G4: High efficacy is Keylight standard. High value: option for more Lumen flux output (more power, more watt) option on request.

SLM 827 + 927. On special request

- SLM Premium White (colour point bBBL) 2000 Lm / 4500 Lm 3000k, On special request

TECHNICAL INFORMATION

PRODUCT

LUXX 3



- PRODUCT MATERIAL** ▶ Die-cast aluminium
- LIGHT SOURCE** ▶ SLM G3
- MODULE LIFETIME** ▶ Approx. 50.000 hours
- LED COOLING** ▶ Passive cooling
- DRIVER** ▶ Incl. Xitanium driver.
- COLORS (Δ)** ▶
 - 3 = RAL 9003 white
 - 5 = RAL 9005 black
 - 6 = RAL 9006 alu
- BEAM ANGLE** ▶ 24°
- ADJUSTABLE** ▶ Yes
- SIZE** ▶ 570 X 190 X 145MM

OPTIONS

- EMERGENCY BALLAST** ▶ 1x 0187.999.99 1 - 3 hours. € 270,00
- DIFFUSER** ▶ 3x 0183.999.99 € 28,50
- DIFFUSER W/ HOLE** ▶ 3x 0189.999.99 € 28,50
- DIMMABLE** ▶ Dimmable DALI € 135,00
- OPTIONAL BEAM ANGLE** ▶ 36° € 15,00

INFORMATION

- WARRANTY** ▶ 5 Years

Δ = product color code. See colors

including cable and plug.

Keylight International B.V. reserves the right to modify or change technical, construction or LED specifications due to continuous improvements of our products and lightsources.



LUXX 3

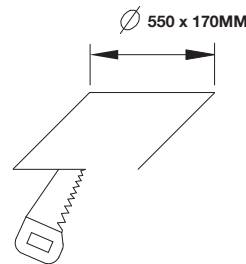

Hole size

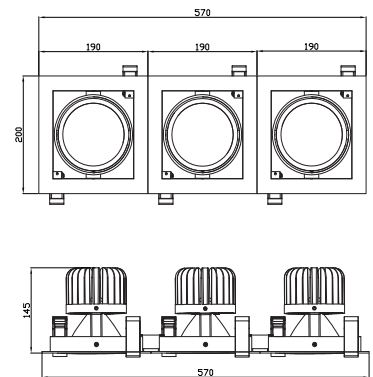

Technical drawing

| ARTICLE NO. | LAMP TYPE | BRAND | LIGHT OUTPUT | MODULE POWER | SETTING | MODULE EFFICIENCY | CORRELATED COLOUR TEMPERATURE | COLOUR RENDERING INDEX | B50/L70 AT TC LIFE | SALES PRICE |
|--------------|---------------------|---------|--------------|--------------|------------------|-------------------|-------------------------------|------------------------|--------------------|-------------|
| Δ see colors | GEN 4 | | LM | W | | LM/W | K | RA | HRS | EURO |
| 4396.111.30Δ | SLM 1100-827 L13 # | Philips | 1160 | 10 | High Efficiency | 114 | 2700 | >82 | 50.000 | € 465,00 |
| 4396.112.30Δ | SLM 1100-830 L13 | Philips | 1240 | 10 | High Efficiency | 122 | 3000 | >82 | 50.000 | € 465,00 |
| 4396.113.30Δ | SLM 1100-840 L13 | Philips | 1330 | 10 | High Efficiency | 130 | 4000 | >82 | 50.000 | € 465,00 |
| 4396.114.30Δ | SLM 2000-830 L13 | Philips | 2020 | 17 | High Efficiency | 117 | 3000 | >82 | 50.000 | € 495,00 |
| 4396.116.30Δ | SLM 2000-840 L13 | Philips | 2150 | 17 | High Efficiency | 124 | 4000 | >82 | 50.000 | € 495,00 |
| 4396.125.30Δ | SLM 2000-927 L13 # | Philips | 1570 | 17 | High Efficiency | 91 | 2700 | >97 | 50.000 | € 500,00 |
| 4396.120.30Δ | SLM 2000-930 L13 | Philips | 1650 | 17 | High Efficiency | 95 | 3000 | >97 | 50.000 | € 500,00 |
| 4396.117.30Δ | SLM 3000-830 L15 | Philips | 2970 | 26 | High Efficiency | 114 | 3000 | >82 | 50.000 | € 525,00 |
| 4396.119.30Δ | SLM 3000-840 L15 | Philips | 3170 | 26 | High Efficiency | 122 | 4000 | >82 | 50.000 | € 525,00 |
| 4396.128.30Δ | SLM 3000-927 L15 # | Philips | 2320 | 26 | High Efficiency | 89 | 2700 | >97 | 50.000 | € 525,00 |
| 4396.121.30Δ | SLM 3000-930 L15 | Philips | 2400 | 26 | High Efficiency | 92 | 3000 | >97 | 50.000 | € 530,00 |
| 4396.135.24Δ | SLM 4500-830 L19 | Philips | 4860 | 42 | High Efficiency | 114 | 3000 | >82 | 50.000 | € 640,00 |
| 4396.136.24Δ | SLM 4500-840 L19 | Philips | 5160 | 42 | High Efficiency | 122 | 4000 | >82 | 50.000 | € 640,00 |
| 4396.157.24Δ | SLM 4500-927 L19 | Philips | 3760 | 42 | High Efficiency | 89 | 2700 | >97 | 50.000 | € 655,00 |
| 4396.137.24Δ | SLM 4500-930 L19 | Philips | 3930 | 42 | High Efficiency | 92 | 3000 | >97 | 50.000 | € 655,00 |
| 4396.109.30Δ | SLM CW 3000-930 L15 | Philips | 2790 | 34 | Crisp White | 82 | 3000 | >92 | 50.000 | € 630,00 |
| 4396.110.30Δ | SLM CW 3800-930 L19 | Philips | 2790 | 34 | Crisp White | 82 | 3000 | >92 | 50.000 | € 745,00 |
| 4396.159.30Δ | SLM FW 2800-925 L19 | Philips | 2880 | 42 | Food Warm White | 69 | 2900 | >90 | 50.000 | € 775,00 |
| 4396.160.30Δ | SLM FR 3000-930 L19 | Philips | 2980 | 42 | Food Premium red | 72 | 3150 | >87 | 50.000 | € 775,00 |

* SLM G4: High efficacy is Keylight standard, High value: option for more Lumen flux output (more power, more watt) option on request.
 # SLM 827 + 927, On special request
 - SLM Premium White (colour point bBBL) 2000 Lm / 4500 Lm 3000k, On special request

TECHNICAL INFORMATION

PRODUCT

UTAH 18 S



- PRODUCT MATERIAL** ▶ Steel + alu
- LIGHT SOURCE** ▶ Twistable G3
- MODULE LIFETIME** ▶ Approx. 50.000 hours
- LED COOLING** ▶ Passive cooling
- DRIVER** ▶ Incl. Integrated driver.
- COLORS (Δ)** ▶
 - 3 = RAL 9003 white
 - 5 = RAL 9005 black
 - 6 = RAL 9006 alu
- BEAM ANGLE** ▶ 80°
- ADJUSTABLE** ▶ No
- SIZE** ▶ 185 X 185 X 172MM

OPTIONS

- COLORS** ▶ Available in all RAL colours on request
Additional price + 10%
- DIMMABLE** ▶ Standard dimmable leading edge.
- GLASS & IP RING** ▶ Optional IP44 ring with clear or mat glass
Price on request.

INFORMATION

- WARRANTY** ▶ 5 Years

Δ = product color code. See colors

Keylight International B.V. reserves the right to modify or change technical, construction or LED specifications due to continuous improvements of our products and lightsources.



UTAH 18 S

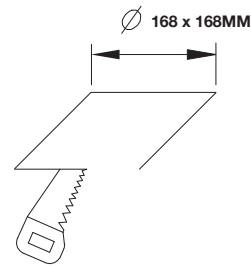

Hole size

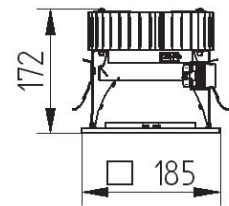

Technical drawing

| ARTICLE NO. | LAMP TYPE | BRAND | LIGHT OUTPUT | MODULE POWER | MODULE EFFICIENCY | CORRELATED COLOUR TEMPERATURE | COLOUR RENDERING INDEX | TC LIFE | POWER FACTOR | SALES PRICE |
|--------------|--------------|---------|--------------|--------------|-------------------|-------------------------------|------------------------|---------|--------------|-------------|
| Δ see colors | | | LM | W | LM/W | K | RA | HRS | PF | EURO |
| 4085.148.80Δ | Twistable G3 | Philips | 2000 | 30 | 70 | 3000 | >80 | 25.000 | >,09 | € 200,00 |
| 4085.149.80Δ | Twistable G3 | Philips | 2000 | 28 | 77 | 4000 | >80 | 25.000 | >,09 | € 200,00 |

TECHNICAL INFORMATION

PRODUCT

NOX S 18



- PRODUCT MATERIAL** ▶ Steel and Alu
- LIGHT SOURCE** ▶ DLM-I / DLM G5 / DLM - Lexel
- MODULE LIFETIME** ▶ DLM-I Approx. 25.000 hours
DLM Approx. 50.000 hours
- LED COOLING** ▶ Passive cooling
- DRIVER DLM-I** ▶ Incl. 230V intergrated driver.
- DRIVER DLM** ▶ Incl. standard xitanium driver.
- COLORS (Δ)** ▶ **3** = RAL 9003 white
 5 = RAL 9005 black
 6 = RAL 9006 alu
- BEAM ANGLE** ▶ 80°
- ADJUSTABLE** ▶ Yes
- SIZE** ▶ 185 X 185 X 175MM

OPTIONS

- COLORS** ▶ Available in all RAL colours on request
Additional price + 10%
- EMERGENCY BALLAST** ▶ DLM: 1 - 3 hours. € 225,00
- DIMMABLE** ▶ DLM: Dimmable or dali € 45,00
- GLASS** ▶ IP44 clear or mat cover on request.

INFORMATION

- WARRANTY** ▶ 5 Years

Δ see colors

Philips LEXEL LED module includes a standard DMX controlled Touch DALI ballast

Keylight International B.V. reserves the right to modify or change technical, construction or LED specifications due to continuous improvements of our products and lightsources.

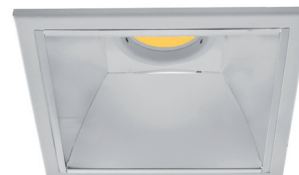

NOX S 18

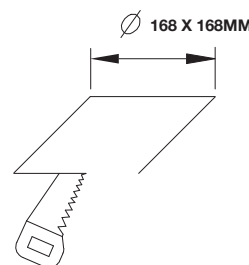

Hole size

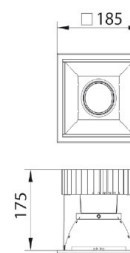

Technical drawing

| ARTICLE NO. | LAMP TYPE | BRAND | LIGHT OUTPUT | MODULE POWER | MODULE EFFICIENCY | CORRELATED COLOUR TEMPERATURE | COLOUR RENDERING INDEX | TC LIFE | POWER FACTOR | SALES PRICE |
|--------------|-----------|---------|--------------|--------------|-------------------|-------------------------------|------------------------|---------|--------------|-------------|
| Δ see colors | | | LM | W | LM/W | K | RA | HRS | PF | EURO |
| 4405.101.80Δ | DLM G5 | Philips | 1100 | 11 | 100 | 3000 | >80 | 50.000 | >,09 | € 220,00 |
| 4405.102.80Δ | DLM G5 | Philips | 1100 | 10 | 110 | 4000 | >80 | 50.000 | >,09 | € 220,00 |
| 4405.103.80Δ | DLM G5 | Philips | 2000 | 21 | 95 | 3000 | >80 | 50.000 | >,09 | € 235,00 |
| 4405.104.80Δ | DLM G5 | Philips | 2000 | 19 | 105 | 4000 | >80 | 50.000 | >,09 | € 235,00 |
| 4405.105.80Δ | DLM G5 | Philips | 3000 | 32 | 94 | 3000 | >80 | 50.000 | >,09 | € 245,00 |
| 4405.106.80Δ | DLM G5 | Philips | 3000 | 29 | 103 | 4000 | >80 | 50.000 | >,09 | € 245,00 |
| 4405.126.80Δ | DLM Lexel | Philips | 1000 | 24 | 42 | 2700-6500 | >80 | 50.000 | >,09 | € 540,00 |
| 4405.127.80Δ | DLM Lexel | Philips | 2000 | 40 | 48 | 2700-6500 | >80 | 50.000 | >,09 | € 580,00 |

TECHNICAL INFORMATION

PRODUCT

QUAD 16



- PRODUCT MATERIAL** ▶ Die-cast aluminium + alu
- LIGHT SOURCE** ▶ DLM-I / DLM G5
- MODULE LIFETIME** ▶ DLM-I Approx. 25.000 hours
DLM Approx. 50.000 hours
- LED COOLING** ▶ Passive cooling
- DRIVER DLM-I** ▶ Incl. 230V intergrated driver.
- DRIVER DLM** ▶ Incl. standard xitanium driver.
- COLORS Δ** ▶ ● **3** = RAL 9003 black
○ **5** = RAL 9005 white
● **6** = RAL 9006 alu
- BEAM ANGLE** ▶ 90°
- ADJUSTABLE** ▶ No
- SIZE** ▶ 176 X 176 X 149MM

OPTIONS

- EMERGENCY BALLAST** ▶ DLM: 1 - 3 hours € 270,00
art. no.: 0187.999.991
- DIMMABLE** ▶ Dimmable DALI € 45,00

INFORMATION

- WARRANTY** ▶ 5 Years

The reflector is made of high quality 320 Alanod material.
including cable and plug.

Keylight International B.V. reserves the right to modify or change technical, construction or LED specifications due to continuous improvements of our products and lightsources.



QUAD 16

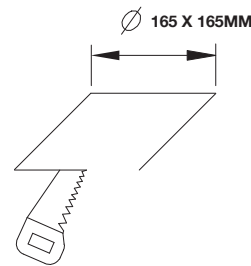

Hole size

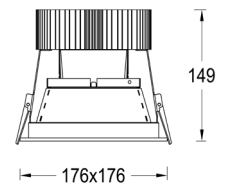

Technical drawing

| ARTICLE NO. | LAMP TYPE | BRAND | LIGHT OUTPUT | MODULE POWER | MODULE EFFICIENCY | CORRELATED COLOUR TEMPERATURE | COLOUR RENDERING INDEX | TC LIFE | POWER FACTOR | SALES PRICE |
|-----------------------|---------------|---------|--------------|--------------|-------------------|-------------------------------|------------------------|---------|--------------|-------------|
| Δ see colors | | | LM | W | LM/W | K | RA | HRS | PF | EURO |
| 4408.122.60. Δ | DLM-Int | Philips | 1100 | 15 | 73 | 3000 | >80 | 25.000 | >,09 | € 190,00 |
| 4408.123.60. Δ | DLM-Int | Philips | 1100 | 14 | 79 | 4000 | >80 | 25.000 | >,09 | € 190,00 |
| 4408.124.60. Δ | DLM-Int | Philips | 2000 | 28 | 71 | 3000 | >80 | 25.000 | >,09 | € 195,00 |
| 4408.125.60. Δ | DLM-Int | Philips | 2000 | 27 | 74 | 4000 | >80 | 25.000 | >,09 | € 195,00 |
| 4408.101.80. Δ | DLM FLEX 1100 | Philips | 1279 | 10.1 | 128 | 3000 | >80 | 60.000 | >,09 | € 195,00 |
| 4408.102.80. Δ | DLM FLEX 1100 | Philips | 1279 | 9.1 | 141 | 4000 | >80 | 60.000 | >,09 | € 195,00 |
| 4408.103.80. Δ | DLM FLEX 2000 | Philips | 2326 | 18.1 | 129 | 3000 | >80 | 60.000 | >,09 | € 210,00 |
| 4408.104.80. Δ | DLM FLEX 2000 | Philips | 2326 | 16.5 | 141 | 4000 | >80 | 60.000 | >,09 | € 210,00 |
| 4408.105.80. Δ | DLM FLEX 3000 | Philips | 3488 | 27 | 129 | 3000 | >80 | 60.000 | >,09 | € 235,00 |
| 4408.106.80. Δ | DLM FLEX 3000 | Philips | 3488 | 24.7 | 141 | 4000 | >80 | 60.000 | >,09 | € 235,00 |

TECHNICAL INFORMATION

PRODUCT

QUAD 20



- PRODUCT MATERIAL** ▶ Die-cast aluminium + alu
- LIGHT SOURCE** ▶ DLM-I / DLM G5
- MODULE LIFETIME** ▶ DLM-I Approx. 25.000 hours
DLM Approx. 50.000 hours
- LED COOLING** ▶ Passive cooling
- DRIVER DLM-I** ▶ Incl. 230V intergrated driver.
- DRIVER DLM** ▶ Incl. standard xitanium driver.
- COLORS** ▶ ● 3 = RAL 9003 white
- BEAM ANGLE** ▶ 70°
- ADJUSTABLE** ▶ No
- SIZE** ▶ 200 X 200 X 157MM

OPTIONS

- EMERGENCY BALLAST** ▶ DLM: 1 - 3 hours € 270,00
art. no.: 0187.999.991
- DIMMABLE** ▶ Dimmable DALI € 45,00

INFORMATION

- WARRANTY** ▶ 5 Years

The reflector is made of high quality 320 Alanod material.
including cable and plug.

Keylight International B.V. reserves the right to modify or change technical, construction or LED specifications due to continuous improvements of our products and lightsources.



QUAD 20

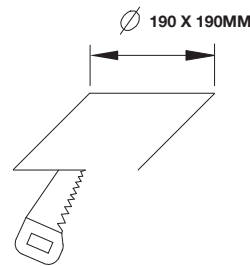

Hole size

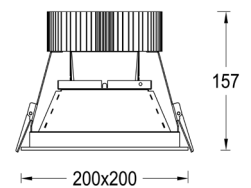

Technical drawing

| ARTICLE NO. | LAMP TYPE | BRAND | LIGHT OUTPUT | | MODULE EFFICIENCY | CORRELATED COLOUR TEMPERATURE | COLOUR RENDERING INDEX | TC LIFE | POWER FACTOR | SALES PRICE |
|---------------|---------------|---------|--------------|------|-------------------|-------------------------------|------------------------|---------|--------------|-------------|
| | | | LM | W | | | | | | |
| 4409.122.60.3 | DLM-Int | Philips | 1100 | 15 | 73 | 3000 | >80 | 25.000 | >,09 | € 195,00 |
| 4409.123.60.3 | DLM-Int | Philips | 1100 | 14 | 79 | 4000 | >80 | 25.000 | >,09 | € 195,00 |
| 4409.124.60.3 | DLM-Int | Philips | 2000 | 28 | 71 | 3000 | >80 | 25.000 | >,09 | € 210,00 |
| 4409.125.60.3 | DLM-Int | Philips | 2000 | 27 | 74 | 4000 | >80 | 25.000 | >,09 | € 210,00 |
| 4409.101.80.3 | DLM FLEX 1100 | Philips | 1279 | 10.1 | 128 | 3000 | >80 | 60.000 | >,09 | € 200,00 |
| 4409.102.80.3 | DLM FLEX 1100 | Philips | 1279 | 9.1 | 141 | 4000 | >80 | 60.000 | >,09 | € 200,00 |
| 4409.103.80.3 | DLM FLEX 2000 | Philips | 2326 | 18.1 | 129 | 3000 | >80 | 60.000 | >,09 | € 215,00 |
| 4409.104.80.3 | DLM FLEX 2000 | Philips | 2326 | 16.5 | 141 | 4000 | >80 | 60.000 | >,09 | € 215,00 |
| 4409.105.80.3 | DLM FLEX 3000 | Philips | 3488 | 27 | 129 | 3000 | >80 | 60.000 | >,09 | € 240,00 |
| 4409.106.80.3 | DLM FLEX 3000 | Philips | 3488 | 24.7 | 141 | 4000 | >80 | 60.000 | >,09 | € 240,00 |

TECHNICAL INFORMATION

PRODUCT

BODY 30



- PRODUCT MATERIAL** ▶ Steel and aluminium
- LIGHT SOURCE** ▶ Osram LED
- MODULE LIFETIME** ▶ Approx. 50.000 hours
- LED COOLING** ▶ Passive cooling
- DRIVER** ▶ Incl. standard Osram driver.
- COLORS (Δ)** ▶
 - 3 = RAL 9003 white
 - 5 = RAL 9005 black
 - 6 = RAL 9006 alu
- REFLECTOR PLATE** ▶ Opal diffuser
- ADJUSTABLE** ▶ No
- SIZE** ▶ 298 X 298 X 70MM

OPTIONS

- COLORS** ▶ Available in all RAL colours on request
Additional price + 10%
- DIMMABLE** ▶ Dimmable or dali € 270,00

INFORMATION

- WARRANTY** ▶ 5 Years

Δ see colors

Keylight International B.V. reserves the right to modify or change technical, construction or LED specifications due to continuous improvements of our products and lightsources.



BODY 30

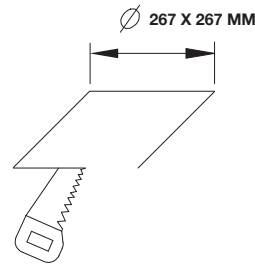

Hole size

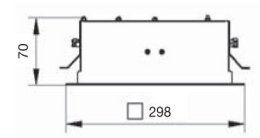

Technical drawing

| ARTICLE NO. | LAMP TYPE | BRAND | LIGHT OUTPUT | MODULE POWER | MODULE EFFICIENCY | CORRELATED COLOUR TEMPERATURE | COLOUR RENDERING INDEX | TC LIFE | POWER FACTOR | SALES PRICE |
|--------------|-----------|-------|--------------|--------------|-------------------|-------------------------------|------------------------|---------|--------------|-------------|
| Δ see colors | | | LM | W | LM/W | K | RA | HRS | PF | EURO |
| 4404.181.91Δ | LED plate | Osram | 1350 | 16 | 84 | 3000 | >80 | 50.000 | | € 335,00 |
| 4404.182.91Δ | LED plate | Osram | 1900 | 23 | 83 | 3000 | >80 | 50.000 | | € 335,00 |
| 4404.183.91Δ | LED plate | Osram | 2500 | 33 | 76 | 3000 | >80 | 50.000 | | € 335,00 |
| 4404.184.91Δ | LED plate | Osram | 1400 | 16 | 87 | 4000 | >80 | 50.000 | | € 335,00 |
| 4404.185.91Δ | LED plate | Osram | 2000 | 23 | 87 | 4000 | >80 | 50.000 | | € 335,00 |
| 4404.186.91Δ | LED plate | Osram | 2600 | 33 | 79 | 4000 | >80 | 50.000 | | € 335,00 |

TECHNICAL INFORMATION

PRODUCT

NORFOLK



- PRODUCT MATERIAL** ▶ Steel and aluminium
- LIGHT SOURCE** ▶ Ledline
- MODULE LIFETIME** ▶ Approx. 50.000 hours
- LED COOLING** ▶ Passive cooling
- DRIVER LEDPLATE** ▶ Incl. standard xitanium driver.
- COLORS (Δ)** ▶
 - 3 = RAL 9003 white
 - 5 = RAL 9005 black
 - 6 = RAL 9006 alu
- REFLECTOR PLATE** ▶ Opal diffuser
- ADJUSTABLE** ▶ No
- SIZE** ▶ 594 X 594 X 120MM

OPTIONS

- COLORS** ▶ Available in all RAL colours on request
Additional price + 10%
- EMERGENCY BALLAST** ▶ 1 - 3 hours. € 225,00
- DIMMABLE** ▶ Dimmable or dali € 45,00

INFORMATION

- WARRANTY** ▶ 5 Years

Δ see colors

Version for gypsum ceiling on request. Designed for modular ceilings.

Keylight International B.V. reserves the right to modify or change technical, construction or LED specifications due to continuous improvements of our products and lightsources.



NORFOLK

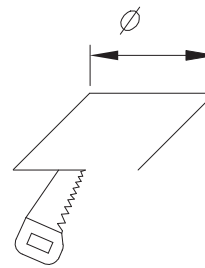

Hole size

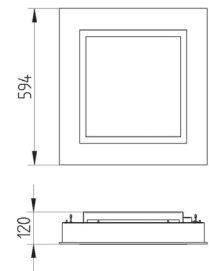

Technical drawing

| ARTICLE NO. | LAMP TYPE | BRAND | LIGHT OUTPUT | MODULE POWER | MODULE EFFICIENCY | CORRELATED COLOUR TEMPERATURE | COLOUR RENDERING INDEX | TC LIFE | POWER FACTOR | SALES PRICE |
|--------------|-----------|---------|--------------|--------------|-------------------|-------------------------------|------------------------|---------|--------------|-------------|
| Δ see colors | | | LM | W | LM/W | K | RA | HRS | PF | EURO |
| 4495.197.91Δ | Ledline | Philips | 8800 | 65 | 120 | 3000 | >80 | 50.000 | | € 665,00 |
| 4495.198.91Δ | Ledline | Philips | 8800 | 65 | 120 | 4000 | >80 | 50.000 | | € 665,00 |

TECHNICAL INFORMATION

PRODUCT

ROOM 60



- PRODUCT MATERIAL** ▶ Steel and aluminium
- LIGHT SOURCE** ▶ Ledline square
- MODULE LIFETIME** ▶ Approx. 50.000 hours
- LED COOLING** ▶ Passive cooling
- DRIVER LEDPLATE** ▶ Incl. standard xitanium driver.
- COLORS (Δ)** ▶
 - 3 = RAL 9003 white
 - 5 = RAL 9005 black
 - 6 = RAL 9006 alu
- REFLECTOR PLATE** ▶ Opal diffuser
- ADJUSTABLE** ▶ No
- SIZE** ▶ 596 X 596 X 107MM

OPTIONS

- COLORS** ▶ Available in all RAL colours on request
Additional price + 10%
- EMERGENCY BALLAST** ▶ 1 - 3 hours. € 225,00
- DIMMABLE** ▶ Dimmable or dali € 45,00

INFORMATION

- WARRANTY** ▶ 5 Years
- Δ see colors
- Version for gypsum ceiling on request. Designed for modular ceilings.

Keylight International B.V. reserves the right to modify or change technical, construction or LED specifications due to continuous improvements of our products and lightsources.



ROOM 60

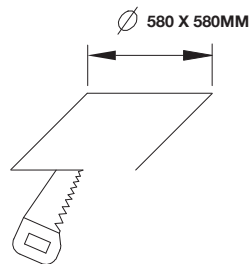

Hole size

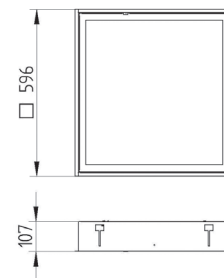

Technical drawing

ROOM 60 (IP44)

| ARTICLE NO. | LAMP TYPE | BRAND | LIGHT OUTPUT | MODULE POWER | MODULE EFFICIENCY | CORRELATED COLOUR TEMPERATURE | COLOUR RENDERING INDEX | TC LIFE | IP | SALES PRICE |
|--------------|-----------|---------|--------------|--------------|-------------------|-------------------------------|------------------------|---------|----|-------------|
| Δ see colors | | | LM | W | LM/W | K | RA | HRS | IP | EURO |
| 8595.195.91Δ | Ledline | Philips | 5000 | 40 | 125 | 3000 | >80 | 50.000 | 44 | € 350,00 |
| 8595.196.91Δ | Ledline | Philips | 5000 | 40 | 125 | 4000 | >80 | 50.000 | 44 | € 350,00 |
| 8595.000.91Δ | Ledline | Philips | 10.000 | 69 | 145 | 3000 | >80 | 50.000 | 44 | € 735,00 |
| 8595.001.91Δ | Ledline | Philips | 10.000 | 69 | 145 | 4000 | >80 | 50.000 | 44 | € 735,00 |

CLEANROOM VERSION (IP65)

| ARTICLE NO. | LAMP TYPE | BRAND | LIGHT OUTPUT | MODULE POWER | MODULE EFFICIENCY | CORRELATED COLOUR TEMPERATURE | COLOUR RENDERING INDEX | TC LIFE | IP | SALES PRICE |
|--------------|-----------|---------|--------------|--------------|-------------------|-------------------------------|------------------------|---------|----|-------------|
| Δ see colors | | | LM | W | LM/W | K | RA | HRS | IP | EURO |
| 8596.195.91Δ | Ledline | Philips | 5000 | 40 | 125 | 3000 | >80 | 50.000 | 44 | € 420,00 |
| 8596.196.91Δ | Ledline | Philips | 5000 | 40 | 125 | 4000 | >80 | 50.000 | 44 | € 420,00 |
| 8596.000.91Δ | Ledline | Philips | 10.000 | 69 | 145 | 3000 | >80 | 50.000 | 44 | € 770,00 |
| 8596.001.91Δ | Ledline | Philips | 10.000 | 69 | 145 | 4000 | >80 | 50.000 | 44 | € 770,00 |

TECHNICAL INFORMATION

PRODUCT

ROOM 120



- PRODUCT MATERIAL** ▶ Steel and aluminium
- LIGHT SOURCE** ▶ Ledline square
- MODULE LIFETIME** ▶ Approx. 50.000 hours
- LED COOLING** ▶ Passive cooling
- DRIVER LEDPLATE** ▶ Incl. standard xitanium driver.
- COLORS (Δ)** ▶
 - 3 = RAL 9003 white
 - 5 = RAL 9005 black
 - 6 = RAL 9006 alu
- REFLECTOR PLATE** ▶ Opal diffuser
- ADJUSTABLE** ▶ No
- SIZE** ▶ 1196 X 296 X 106MM

OPTIONS

- COLORS** ▶ Available in all RAL colours on request
Additional price + 10%
- EMERGENCY BALLAST** ▶ 1 - 3 hours. € 225,00
- DIMMABLE** ▶ Dimmable or dali € 45,00

INFORMATION

- WARRANTY** ▶ 5 Years
- Δ see colors
- Version for gypsum ceiling on request. Designed for modular ceilings

Keylight International B.V. reserves the right to modify or change technical, construction or LED specifications due to continuous improvements of our products and lightsources.



ROOM 120

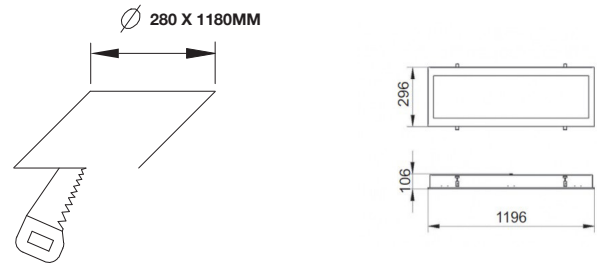

Hole size

Technical drawing

ROOM 120 (IP44)

| ARTICLE NO. | LAMP TYPE | BRAND | LIGHT OUTPUT | MODULE POWER | MODULE EFFICIENCY | CORRELATED COLOUR TEMPERATURE | COLOUR RENDERING INDEX | TC LIFE | IP | SALES PRICE |
|--------------|-----------|---------|--------------|--------------|-------------------|-------------------------------|------------------------|---------|----|-------------|
| Δ see colors | | | LM | W | LM/W | K | RA | HRS | IP | EURO |
| 8195.195.91Δ | Ledline | Philips | 5000 | 40 | 125 | 3000 | >80 | 50.000 | 44 | € 490,00 |
| 8195.196.91Δ | Ledline | Philips | 5000 | 40 | 125 | 4000 | >80 | 50.000 | 44 | € 490,00 |
| 8195.000.91Δ | Ledline | Philips | 10.000 | 69 | 145 | 3000 | >80 | 50.000 | 44 | € 770,00 |
| 8195.001.91Δ | Ledline | Philips | 10.000 | 69 | 145 | 4000 | >80 | 50.000 | 44 | € 770,00 |

CLEANROOM VERSION (IP65)

| ARTICLE NO. | LAMP TYPE | BRAND | LIGHT OUTPUT | MODULE POWER | MODULE EFFICIENCY | CORRELATED COLOUR TEMPERATURE | COLOUR RENDERING INDEX | TC LIFE | IP | SALES PRICE |
|--------------|-----------|---------|--------------|--------------|-------------------|-------------------------------|------------------------|---------|----|-------------|
| Δ see colors | | | LM | W | LM/W | K | RA | HRS | IP | EURO |
| 8196.195.91Δ | Ledline | Philips | 5000 | 40 | 125 | 3000 | >80 | 50.000 | 44 | € 525,00 |
| 8196.196.91Δ | Ledline | Philips | 5000 | 40 | 125 | 4000 | >80 | 50.000 | 44 | € 525,00 |
| 8196.000.91Δ | Ledline | Philips | 10.000 | 69 | 145 | 3000 | >80 | 50.000 | 44 | € 800,00 |
| 8196.001.91Δ | Ledline | Philips | 10.000 | 69 | 145 | 4000 | >80 | 50.000 | 44 | € 800,00 |

TECHNICAL INFORMATION

PRODUCT

INSERT 60



- PRODUCT MATERIAL** ▶ Aluminium
- LIGHT SOURCE** ▶ Philips Certaflex
- DRIVER** ▶ Philips Xitanium driver
- COLORS (Δ)** ▶ ● 3 = RAL 9010 White
- ADJUSTABLE** ▶ No
- SIZE** ▶ 595 X 595 X 55MM

INFORMATION

- WARRANTY** ▶ 2 years warranty

Incl. GST18/3

Reflector Mat Parabol

Keylight International B.V. reserves the right to modify or change technical, construction or LED specifications due to continuous improvements of our products and lightsources.



INSERT 60 LED

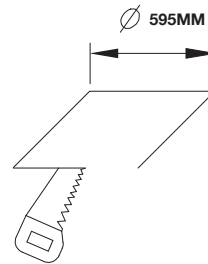

Hole size

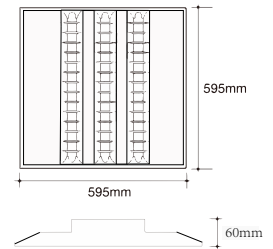

Technical drawing

| ARTICLE NO. | LAMP TYPE | BRAND | LIGHT OUTPUT | MODULE POWER | MODULE EFFICIENCY | CORRELATED COLOUR TEMPERATURE | COLOUR RENDERING INDEX | TC LIFE | SALES PRICE |
|---------------|-----------|---------|--------------|--------------|-------------------|-------------------------------|------------------------|---------|-------------|
| | | | LM | W | LM/W | K | RA | HRS | EURO |
| 4741.193.99.3 | Certaflex | Philips | 4650 | 42 | 110 | 4000 | >80 | 30.000 | € 189,00 |
| 4741.194.99.3 | Certaflex | Philips | 4650 | 42 | 110 | 6500 | >80 | 30.000 | € 189,00 |

TECHNICAL INFORMATION

PRODUCT

ARC 60



- PRODUCT MATERIAL** ▶ Steel and aluminium
- LIGHT SOURCE** ▶ Ledline
- MODULE LIFETIME** ▶ Approx. 50.000 hours
- LED COOLING** ▶ Passive cooling
- DRIVER LEDPLATE** ▶ Incl. standard xitanium driver.
- COLORS (Δ)** ▶
 - 3 = RAL 9003 white
 - 5 = RAL 9005 black
 - 6 = RAL 9006 alu
- REFLECTOR PLATE** ▶ Opal diffuser
- ADJUSTABLE** ▶ No
- SIZE** ▶ 635 X 635 X 100MM

OPTIONS

- COLORS** ▶ Available in all RAL colours on request
Additional price + 10%
- DIMMABLE** ▶ Dimmable or dali € 270,00

INFORMATION

- WARRANTY** ▶ 5 Years

Δ see colors

Keylight International B.V. reserves the right to modify or change technical, construction or LED specifications due to continuous improvements of our products and lightsources.

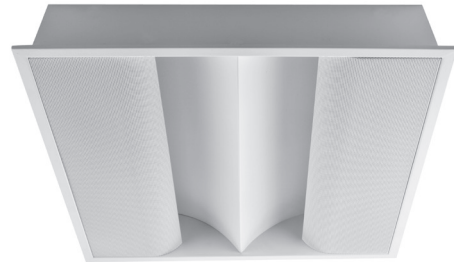

ARC 60

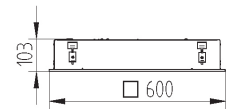

Technical drawing

| ARTICLE NO. | LAMP TYPE | BRAND | LIGHT OUTPUT | MODULE POWER | MODULE EFFICIENCY | CORRELATED COLOUR TEMPERATURE | COLOUR RENDERING INDEX | TC LIFE | SALES PRICE |
|--------------|-----------|---------|--------------|--------------|-------------------|-------------------------------|------------------------|---------|-------------|
| Δ see colors | | | LM | W | LM/W | K | RA | HRS | EURO |
| 8597.197.99Δ | Ledline | Philips | 2X 2200 | 2X 16 | 2X 137 | 3000 | >80 | 50.000 | € 395,00 |
| 8597.198.99Δ | Ledline | Philips | 2X 2200 | 2X 16 | 2X 137 | 4000 | >80 | 50.000 | € 395,00 |



Surface Round



TUBE
PAGE 112



LOOK
PAGE 113



BUSS 12
PAGE 1



BUSS 19
PAGE 1



SOL 17 T
PAGE 1



SOL 17
PAGE 1



PARIS 19
PAGE 1



PARIS 26 MS
PAGE 1



ORBIT 20
PAGE 1



ORBIT 30
PAGE 1



ORBIT 40
PAGE 1



ORBIT 65
PAGE 1



ORBIT 90
PAGE 1

Surface Round

| | |
|-----------|--------|
| UTAH 18 | PAGE 1 |
| YORK | PAGE 1 |
| DL 180 | PAGE 1 |
| KANSAS 16 | PAGE 1 |
| DEEP 22 | PAGE 1 |
| VISION 15 | PAGE 1 |
| VISION 20 | PAGE 1 |
| ROLED | PAGE 1 |
| CAP R1 | PAGE 1 |
| CAP R2 | PAGE 1 |
| CAP R2 | PAGE 1 |
| CAP R1 | PAGE 1 |
| CAP R2 | PAGE 1 |

TECHNICAL INFORMATION

PRODUCT

TUBE



- PRODUCT MATERIAL ▶ Aluminium
- LIGHT SOURCE ▶ MR16 LED / LMR50
- DRIVER ▶ LMR 50 includes a driver
- COLORS (Δ) ▶
 - 3 = RAL 9003
 - 5 = RAL 9005
 - 6 = RAL 9006
- BEAM ANGLE ▶ LMR: 20° / 30°
- ADJUSTABLE ▶ Yes
- SIZE ▶ 96 X 120MM

OPTIONS LMR

- DIMMABLE DRIVER IN COMBINATION WITH TUBE ▶
 - OSRAM 8.5W 1/10v 350mA € 23,50
art. no.: 0110.999.99.0
 - OSRAM 13W phase-cut 350 mA € 23,50
art. no.: 0111.999.99.0
- OPTIONAL FRONT RING ▶ LMR50 Aluminium colour. € 3,95
art. no.: 0052.999.99.6
- MOUNTING BRACKET ▶ LMR50 incl. mounting set € 5,00
art. no.: 0051.999.99.5
- GLASS COVER CLEAR ▶ LMR50 glass IP44 € 7,50
art. no.: 0053.999.99.0

INFORMATION

- WARRANTY ▶ 5 Years
- Δ see colors

Keylight International B.V. reserves the right to modify or change technical, construction or LED specifications due to continuous improvements of our products and lightsources.



TUBE

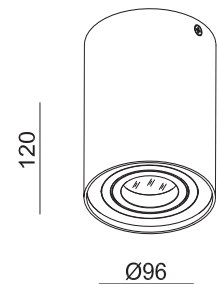

Technical drawing



LMR50

| ARTICLE NO. | LAMP TYPE | BRAND | LIGHT OUTPUT | MODULE POWER | MODULE EFFICIENCY | CORRELATED COLOUR TEMPERATURE | COLOUR RENDERING INDEX | TC LIFE | REFL. | mA | SALES PRICE |
|----------------|-----------|-----------|--------------|--------------|-------------------|-------------------------------|------------------------|---------|--------|-----|-------------|
| Δ see colors | | | LM | W | LM/W | K | RA | HRS | DEGREE | mA | EURO |
| ! 5025.999.99Δ | Gu5.3 | | | Max. 50W | | | | | | | € 45,00 |
| ! 5025.999.99Δ | Gu10 | | | Max. 50W | | | | | | | € 45,00 |
| 5025.171.20Δ | LMR50 | Bridgelux | 560 | 6.6 | 79 | 2700 | >80 | 25.000 | 20° | 350 | € 85,00 |
| 5025.172.30Δ | LMR50 | Bridgelux | 560 | 6.6 | 79 | 2700 | >80 | 25.000 | 30° | 350 | € 85,00 |
| 5025.173.20Δ | LMR50 | Bridgelux | 600 | 6.6 | 86 | 3000 | >80 | 25.000 | 20° | 350 | € 85,00 |
| 5025.174.30Δ | LMR50 | Bridgelux | 600 | 6.6 | 86 | 3000 | >80 | 25.000 | 30° | 350 | € 85,00 |

TECHNICAL INFORMATION

PRODUCT

LOOK



- PRODUCT MATERIAL** ▶ Die-cast aluminium
- LIGHT SOURCE** ▶ V8 Array
- MODULE LIFETIME** ▶ Approx. 30.000 hours
- LED COOLING** ▶ Passive cooling
- DRIVER** ▶ Incl. standard driver
- COLORS (Δ)** ▶
 - = RAL 9005 black
 - + ● = 35 = Black & white
 - + ● = 65 = Gray & black
- BEAM ANGLE** ▶ 32°
- ADJUSTABLE** ▶ 350° rotational
90° rotational spot head
- SIZE** ▶ 100 X 103MM. See technical drawing

OPTIONS

- DIMMABLE** ▶ Lumotech 12W Mains trailing edge 500mA € 55,00
art. no.: 0135.500.99.0

INFORMATION

- WARRANTY** ▶ 5 Years

Δ = product color code. See colors

Keylight International B.V. reserves the right to modify or change technical, construction or LED specifications due to continuous improvements of our products and lightsources.



LOOK

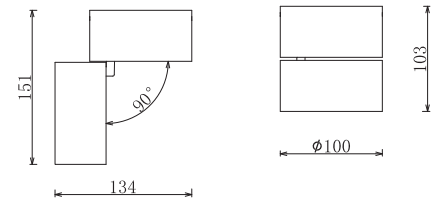

Technical drawing



| ARTICLE NO. | LAMP TYPE | BRAND | LIGHT OUTPUT | MODULE POWER | MODULE EFFICIENCY | CORRELATED COLOUR TEMPERATURE | COLOUR RENDERING INDEX | TC LIFE | mA | SALES PRICE |
|--------------|-----------|-----------|--------------|--------------|-------------------|-------------------------------|------------------------|---------|-----|-------------|
| Δ see colors | | | LM | W | LM/W | K | RA | HRS | | EURO |
| 6019.999.23Δ | V8 Array | Bridgelux | 970 | 9.3 | 113 | 2700 | >80 | 30.000 | 500 | € 155,00 |

TECHNICAL INFORMATION

PRODUCT

BUSS 12



- PRODUCT MATERIAL** ▶ Aluminium
- LIGHT SOURCE** ▶ DISK G3
- MODULE LIFETIME** ▶ Approx. 50.000 hours
- LED COOLING** ▶ Passive cooling
- DRIVER** ▶ Incl. Integrated driver.
- COLORS (Δ)** ▶
 - 3 = RAL 9003 white
 - 5 = RAL 9005 black
 - 6 = RAL 9006 alu
- BEAM ANGLE** ▶ 80°
- ADJUSTABLE** ▶ No
- SIZE** ▶ 90 X 125MM

OPTIONS

- COLORS** ▶ Available in all RAL colours on request.
Additional price + 10%
- DIMMABLE** ▶ Standard Dimmable leading edge

INFORMATION

- WARRANTY** ▶ 5 Years

Δ = product color code. See colors

Keylight International B.V. reserves the right to modify or change technical, construction or LED specifications due to continuous improvements of our products and lightsources.



BUSS 12

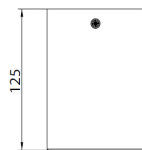
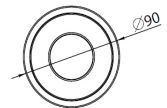

Technical drawing

| ARTICLE NO. | LAMP TYPE | BRAND | LIGHT OUTPUT | MODULE POWER | MODULE EFFICIENCY | CORRELATED COLOUR TEMPERATURE | COLOUR RENDERING INDEX | TC LIFE | POWER FACTOR | SALES PRICE |
|--------------|-----------|---------|--------------|--------------|-------------------|-------------------------------|------------------------|---------|--------------|-------------|
| Δ see colors | | | LM | W | LM/W | K | RA | HRS | PF | EURO |
| 0000.141.85Δ | Disk G3 | Philips | 800 | 12 | 68 | 2700 | >80 | 50.000 | >,09 | € 135,00 |
| 0000.142.85Δ | Disk G3 | Philips | 800 | 12 | 68 | 3000 | >80 | 50.000 | >,09 | € 135,00 |
| 0000.143.85Δ | Disk G3 | Philips | 850 | 11 | 72 | 4000 | >80 | 50.000 | >,09 | € 135,00 |

TECHNICAL INFORMATION

PRODUCT

BUSS 19



- ▶ **PRODUCT MATERIAL** Steel and aluminium
- ▶ **LIGHT SOURCE** Philips DLM-S
- ▶ **MODULE LIFETIME** Approx. 30.000 hours
- ▶ **LED COOLING** Passive cooling
- ▶ **DRIVER** Incl. Intergrated Driver
- ▶ **COLORS Δ**
 - 3 = RAL 9003 white
 - 5 = RAL 9005
 - 6 = RAL 9006
- ▶ **BEAM ANGLE** 80°
- ▶ **REFLECTOR** Silver Glossy
- ▶ **ADJUSTABLE** No
- ▶ **SIZE** 142 X 89MM

OPTIONS

- ▶ **REFLECTOR** White reflector on request.
- ▶ **IP44 VERSION** on request

INFORMATION

- ▶ **WARRANTY** 2 Years

Keylight International B.V. reserves the right to modify or change technical, construction or LED specifications due to continuous improvements of our products and lightsources.



BUSS 19

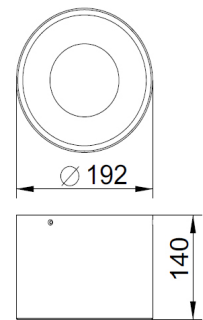

Technical drawing

| ARTICLE NO. | LAMP TYPE | BRAND | LIGHT OUTPUT | MODULE POWER | MODULE EFFICIENCY | CORRELATED COLOUR TEMPERATURE | COLOUR RENDERING INDEX | TC LIFE | POWER FACTOR | SALES PRICE |
|---------------|-----------|---------|--------------|--------------|-------------------|-------------------------------|------------------------|---------|--------------|-------------|
| | | | LM | W | LM/W | K | RA | HRS | PF | EURO |
| 0000.103.80.3 | DLM-S | Philips | 2000 | 26 | 70 | 3000 | >80 | 30.000 | >09, | € 120,00 |
| 0000.140.80.3 | DLM-S | Philips | 2000 | 26 | 70 | 4000 | >80 | 30.000 | >09, | € 120,00 |

TECHNICAL INFORMATION

PRODUCT

SOL 17 T



- PRODUCT MATERIAL** ▶ Steel + alu
- LIGHT SOURCE** ▶ Twistable G3
- MODULE LIFETIME** ▶ Approx. 50.000 hours
- LED COOLING** ▶ Passive cooling
- DRIVER** ▶ Incl. Integrated driver.
- COLORS (Δ)** ▶
 - 3 = RAL 9003 white
 - 5 = RAL 9005 black
 - 6 = RAL 9006 alu
- BEAM ANGLE** ▶ 80°
- ADJUSTABLE** ▶ No
- SIZE** ▶ 170 X 193MM

OPTIONS

- COLORS** ▶ Available in all RAL colours on request.
Additional price + 10%
- GLASS & IP RING** ▶ Optional IP44 ring with clear or mat glass
Price on request.

INFORMATION

- WARRANTY** ▶ 5 Years

Δ = product color code. See colors

Including standard dimmable leading edge.

Keylight International B.V. reserves the right to modify or change technical, construction or LED specifications due to continuous improvements of our products and lightsources.



SOL 17 T

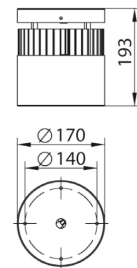

Technical drawing

| ARTICLE NO. | LAMP TYPE | BRAND | LIGHT OUTPUT | MODULE POWER | MODULE EFFICIENCY | CORRELATED COLOUR TEMPERATURE | COLOUR RENDERING INDEX | TC LIFE | SALES PRICE |
|--------------|--------------|---------|--------------|--------------|-------------------|-------------------------------|------------------------|---------|-------------|
| Δ see colors | | | LM | W | LM/W | K | RA | HRS | EURO |
| 5017.146.80Δ | Twistable G3 | Philips | 1100 | 16 | 71 | 3000 | >80 | 50.000 | € 190,00 |
| 5017.147.80Δ | Twistable G3 | Philips | 1100 | 15 | 82 | 4000 | >80 | 50.000 | € 190,00 |

TECHNICAL INFORMATION

PRODUCT

SOL 17



- PRODUCT MATERIAL** ▶ Steel and Alu
- LIGHT SOURCE** ▶ DLM G5
- MODULE LIFETIME** ▶ Approx. 50.000 hours
- LED COOLING** ▶ Passive cooling
- DRIVER DLM-I** ▶ Incl. 230V intergrated driver.
- DRIVER DLM** ▶ Incl. standard xitanium driver.
- COLORS** ▶
 - 3 = RAL 9003 white
 - 5 = RAL 9005 black
 - 6 = RAL 9006 alu
- BEAM ANGLE** ▶ 80°
- ADJUSTABLE** ▶ No
- SIZE** ▶ 170 X 240MM

OPTIONS

- COLORS** ▶ Available in all RAL colours on request
Additional price + 10%
- DIMMABLE** ▶ DLM: Dimmable or dali € 45,00
- GLASS & IP RING** ▶ Optional IP44 ring with clear or mat glass
Price on request.
- PENDENT** ▶ Also available as a pendent version on req.

INFORMATION

- WARRANTY** ▶ 5 Years

Δ see colors

Keylight International B.V. reserves the right to modify or change technical, construction or LED specifications due to continuous improvements of our products and lightsources.



SOL 17

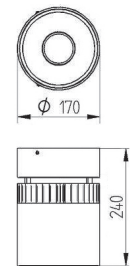

Technical drawing

| ARTICLE NO. | LAMP TYPE | BRAND | LIGHT OUTPUT | MODULE POWER | MODULE EFFICIENCY | CORRELATED COLOUR TEMPERATURE | COLOUR RENDERING INDEX | TC LIFE | POWER FACTOR | SALES PRICE |
|--------------|-----------|---------|--------------|--------------|-------------------|-------------------------------|------------------------|---------|--------------|-------------|
| Δ see colors | | | LM | W | LM/W | K | RA | HRS | PF | EURO |
| 5170.101.80Δ | DLM G5 | Philips | 1100 | 11 | 100 | 3000 | >80 | 50.000 | >,09 | € 265,00 |
| 5170.102.80Δ | DLM G5 | Philips | 1100 | 10 | 110 | 4000 | >80 | 50.000 | >,09 | € 265,00 |
| 5170.103.80Δ | DLM G5 | Philips | 2000 | 21 | 95 | 3000 | >80 | 50.000 | >,09 | € 280,00 |
| 5170.104.80Δ | DLM G5 | Philips | 2000 | 19 | 105 | 3000 | >80 | 50.000 | >,09 | € 280,00 |
| 5170.105.80Δ | DLM G5 | Philips | 3000 | 32 | 94 | 3000 | >80 | 50.000 | >,09 | € 290,00 |
| 5170.106.80Δ | DLM G5 | Philips | 3000 | 29 | 103 | 4000 | >80 | 50.000 | >,09 | € 290,00 |

TECHNICAL INFORMATION

PRODUCT

PARIS 19



- ▶ **PRODUCT MATERIAL** Aluminium
- ▶ **LIGHT SOURCE** LED Stripe SMD 5630
- ▶ **MODULE LIFETIME** Approx. 30.000 hours
- ▶ **LED COOLING** Passive cooling
- ▶ **DRIVER** Incl. Integrated driver.
- ▶ **COLORS (Δ)** ● 3 = RAL 9003 white
- ▶ **BEAM ANGLE** 120°
- ▶ **ADJUSTABLE** No
- ▶ **SIZE** DIAMETER 326 X 113MM

INFORMATION

- ▶ **WARRANTY** 3 Years

Cover PMMA.

Keylight International B.V. reserves the right to modify or change technical, construction or LED specifications due to continuous improvements of our products and lightsources.

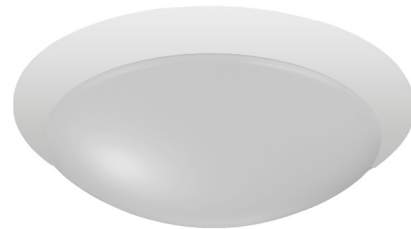

PARIS 19

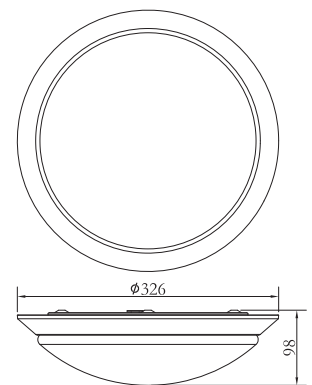

Technical drawing

| ARTICLE NO. | LAMP TYPE | BRAND | LIGHT OUTPUT | MODULE POWER | MODULE EFFICIENCY | CORRELATED COLOUR TEMPERATURE | COLOUR RENDERING INDEX | TC LIFE | POWER FACTOR | SALES PRICE |
|---------------|------------|-------|--------------|--------------|-------------------|-------------------------------|------------------------|---------|--------------|-------------|
| | | | LM | W | LM/W | K | RA | HRS | PF | EURO |
| 5130.990.86.3 | LED Stripe | KL | 1020 | 19 | 54 | 3000 | >80 | 30.000 | >0.9 | € 80,00 |
| 5140.990.86.3 | LED Stripe | KL | 1020 | 19 | 54 | 4000 | >80 | 30.000 | >0.9 | € 80,00 |

TECHNICAL INFORMATION

PRODUCT

PARIS 26 MS



- PRODUCT MATERIAL ▶ Aluminium
- LIGHT SOURCE ▶ LED Stripe SMD 5630
- MODULE LIFETIME ▶ Approx. 30.000 hours
- LED COOLING ▶ Passive cooling
- DRIVER ▶ Incl. Integrated driver.
- COLORS (Δ) ▶ ● 3 = RAL 9003 white
- BEAM ANGLE ▶ 120°
- ADJUSTABLE ▶ No
- SIZE ▶ DIAMETER 395 X 113MM

(MS) MOTION SENSOR

- DETECTION ZONE ▶ 10/30/50/75/100% AVAILABLE
- LAG TIME (S/M) ▶ 5S / 30S / 180S / 15M / 25M
- DAY/NIGHT SETTING ▶ 2-50LX DAY/NIGHTFALL
- DETECTION PRINCIPLE ▶ SENSOR RANGE AVAILABLE
- DETECTION ZONE ▶ MAX. 8MX5M
- DETECTION ANGLE ▶ 30-150°
- MOUNTING HEIGHT ▶ MAX 5M.

INFORMATION

- WARRANTY ▶ 3 Years

Cover PMMA.

Keylight International B.V. reserves the right to modify or change technical, construction or LED specifications due to continuous improvements of our products and lightsources.

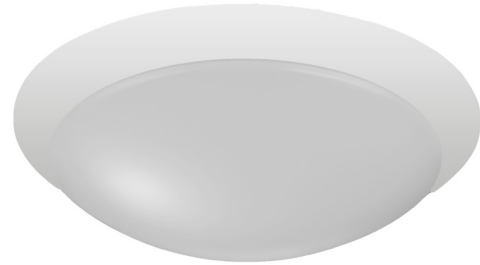

PARIS 26

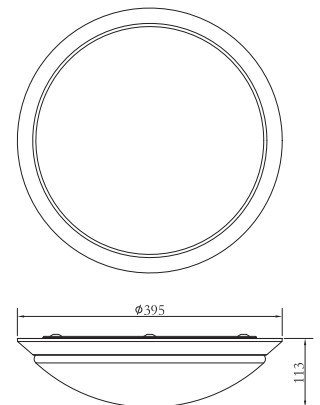

Technical drawing

| ARTICLE NO. | LAMP TYPE | BRAND | LIGHT OUTPUT | MODULE POWER | MODULE EFFICIENCY | CORRELATED COLOUR TEMPERATURE | COLOUR RENDERING INDEX | TC LIFE | POWER FACTOR | SALES PRICE |
|---------------|------------|-------|--------------|--------------|-------------------|-------------------------------|------------------------|---------|--------------|-------------|
| | | | LM | W | LM/W | K | RA | HRS | PF | EURO |
| 5230.990.86.3 | LED Stripe | KL | 1400 | 26 | 54 | 3000 | >80 | 30.000 | >0.9 | € 140,00 |

TECHNICAL INFORMATION

PRODUCT

ORBIT 20



- ▶ **PRODUCT MATERIAL** Steel and aluminium
- ▶ **LIGHT SOURCE** LEDLine
- ▶ **MODULE LIFETIME** Approx. 50.000 hours
- ▶ **LED COOLING** Passive cooling
- ▶ **DRIVER** Incl. standard Osram driver.
- ▶ **COLORS (Δ)**
 - 3 = RAL 9003 white
 - 5 = RAL 9005 black
 - 6 = RAL 9006 alu
- ▶ **REFLECTOR PLATE** Opal diffuser
- ▶ **ADJUSTABLE** No
- ▶ **SIZE** 195 X 75MM

OPTIONS

- ▶ **COLORS** Available in all RAL colours on request
Additional price + 10%
- ▶ **DIMMABLE** Dimmable or dali € 45,00
- ▶ **PENDENT** Also available as a pendent version on req.

INFORMATION

- ▶ **WARRANTY** 5 Years

Δ see colors

Keylight International B.V. reserves the right to modify or change technical, construction or LED specifications due to continuous improvements of our products and lightsources.



ORBIT 20

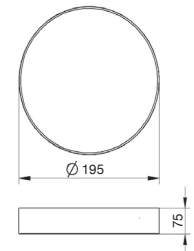

Technical drawing

| ARTICLE NO. | LAMP TYPE | BRAND | LIGHT OUTPUT | MODULE POWER | MODULE EFFICIENCY | CORRELATED COLOUR TEMPERATURE | COLOUR RENDERING INDEX | TC LIFE | SALES PRICE |
|--------------|-----------|-------|--------------|--------------|-------------------|-------------------------------|------------------------|---------|-------------|
| Δ see colors | | | LM | W | LM/W | K | RA | HRS | EURO |
| 5002.181.91Δ | LED plate | Osram | 1300 | 12 | 108 | 3000 | >80 | 50.000 | € 225,00 |
| 5002.182.91Δ | LED plate | Osram | 1300 | 11 | 118 | 4000 | >80 | 50.000 | € 225,00 |

TECHNICAL INFORMATION

PRODUCT

ORBIT 30



- PRODUCT MATERIAL** ▶ Steel and aluminium
- LIGHT SOURCE** ▶ Osram LEDPlate
- MODULE LIFETIME** ▶ Approx. 50.000 hours
- LED COOLING** ▶ Passive cooling
- DRIVER** ▶ Incl. standard Osram driver.
- COLORS (Δ)** ▶
 - 3 = RAL 9003 white
 - 5 = RAL 9005 black
 - 6 = RAL 9006 alu
- REFLECTOR PLATE** ▶ Opal diffuser
- ADJUSTABLE** ▶ No
- SIZE** ▶ 300 X 125MM

OPTIONS

- COLORS** ▶ Available in all RAL colours on request
Additional price + 10%
- DIMMABLE** ▶ Dimmable or dali € 45,00
- PENDENT** ▶ Also available as a pendent version on req.

INFORMATION

- WARRANTY** ▶ 5 Years

Δ see colors

Keylight International B.V. reserves the right to modify or change technical, construction or LED specifications due to continuous improvements of our products and lightsources.



ORBIT 30

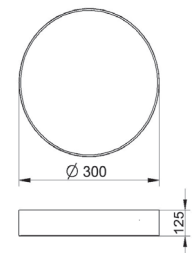

Technical drawing

| ARTICLE NO. | LAMP TYPE | BRAND | LIGHT OUTPUT | MODULE POWER | MODULE EFFICIENCY | CORRELATED COLOUR TEMPERATURE | COLOUR RENDERING INDEX | TC LIFE | SALES PRICE |
|--------------|-----------|-------|--------------|--------------|-------------------|-------------------------------|------------------------|---------|-------------|
| Δ see colors | | | LM | W | LM/W | K | RA | HRS | EURO |
| 5003.181.91Δ | LEDPlate | Osram | 1350 | 16 | 84 | 3000 | >80 | 50.000 | € 310,00 |
| 5003.182.91Δ | LEDPlate | Osram | 1900 | 23 | 83 | 3000 | >80 | 50.000 | € 310,00 |
| 5003.183.91Δ | LEDPlate | Osram | 2500 | 33 | 76 | 3000 | >80 | 50.000 | € 310,00 |
| 5003.184.91Δ | LEDPlate | Osram | 1400 | 16 | 87 | 4000 | >80 | 50.000 | € 310,00 |
| 5003.185.91Δ | LEDPlate | Osram | 2000 | 23 | 87 | 4000 | >80 | 50.000 | € 310,00 |
| 5003.186.91Δ | LEDPlate | Osram | 2600 | 33 | 79 | 4000 | >80 | 50.000 | € 310,00 |



TECHNICAL INFORMATION

PRODUCT

ORBIT 40

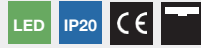

- PRODUCT MATERIAL** ▶ Steel and aluminium
- LIGHT SOURCE** ▶ Philips LEDLine
- MODULE LIFETIME** ▶ Approx. 50.000 hours
- LED COOLING** ▶ Passive cooling
- DRIVER** ▶ Incl. standard Philips driver.
- COLORS (Δ)** ▶
 - 3 = RAL 9003 white
 - 5 = RAL 9005 black
 - 6 = RAL 9006 alu
- REFLECTOR PLATE** ▶ Opal diffuser
- ADJUSTABLE** ▶ No
- SIZE** ▶ 425 X 125MM

OPTIONS

- COLORS** ▶ Available in all RAL colours on request
Additional price + 10%
- DIMMABLE** ▶ Dimmable or dali € 45,00
- PENDENT** ▶ Also available as a pendent version on req.

INFORMATION

- WARRANTY** ▶ 5 Years

Δ see colors

Keylight International B.V. reserves the right to modify or change technical, construction or LED specifications due to continuous improvements of our products and lightsources.



ORBIT 40

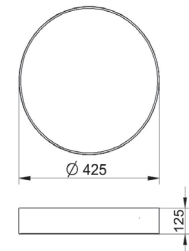

Technical drawing

| ARTICLE NO. | LAMP TYPE | BRAND | LIGHT OUTPUT | MODULE POWER | MODULE EFFICIENCY | CORRELATED COLOUR TEMPERATURE | COLOUR RENDERING INDEX | TC LIFE | SALES PRICE |
|--------------|-----------|---------|--------------|--------------|-------------------|-------------------------------|------------------------|---------|-------------|
| Δ see colors | | | LM | W | LM/W | K | RA | HRS | EURO |
| 5425.195.91Δ | LEDLine | Philips | 2600 | 19 | 137 | 3000 | >80 | 50.000 | € 365,00 |
| 5425.196.91Δ | LEDLine | Philips | 2600 | 19 | 137 | 4000 | >80 | 50.000 | € 365,00 |

TECHNICAL INFORMATION

PRODUCT

ORBIT 65



- PRODUCT MATERIAL** ▶ Steel and aluminium
- LIGHT SOURCE** ▶ Philips LEDLine
- MODULE LIFETIME** ▶ Approx. 50.000 hours
- LED COOLING** ▶ Passive cooling
- DRIVER** ▶ Incl. standard Philips driver.
- COLORS (Δ)** ▶
 - 3 = RAL 9003 white
 - 5 = RAL 9005 black
 - 6 = RAL 9006 alu
- REFLECTOR PLATE** ▶ Opal diffuser
- ADJUSTABLE** ▶ No
- SIZE** ▶ 650 X 112MM

OPTIONS

- COLORS** ▶ Available in all RAL colours on request
Additional price + 10%
- DIMMABLE** ▶ Dimmable or dali € 45,00
- PENDENT** ▶ Also available as a pendent version on req.

INFORMATION

- WARRANTY** ▶ 5 Years

Δ see colors

Keylight International B.V. reserves the right to modify or change technical, construction or LED specifications due to continuous improvements of our products and lightsources.



ORBIT 65

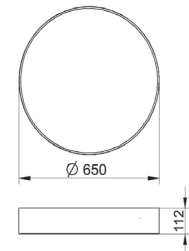

Technical drawing

| ARTICLE NO. | LAMP TYPE | BRAND | LIGHT OUTPUT | MODULE POWER | MODULE EFFICIENCY | CORRELATED COLOUR TEMPERATURE | COLOUR RENDERING INDEX | TC LIFE | SALES PRICE |
|--------------|-----------|---------|--------------|--------------|-------------------|-------------------------------|------------------------|---------|-------------|
| Δ see colors | | | LM | W | LM/W | K | RA | HRS | EURO |
| 5650.195.91Δ | LEDLine | Philips | 5200 | 37 | 140 | 3000 | >80 | 50.000 | € 700,00 |
| 5650.196.91Δ | LEDLine | Philips | 5200 | 37 | 140 | 4000 | >80 | 50.000 | € 700,00 |

TECHNICAL INFORMATION

PRODUCT

ORBIT 90



- PRODUCT MATERIAL** ▶ Steel and aluminium
- LIGHT SOURCE** ▶ Philips LEDLine
- MODULE LIFETIME** ▶ Approx. 50.000 hours
- LED COOLING** ▶ Passive cooling
- DRIVER** ▶ Incl. standard Philips driver.
- COLORS (Δ)** ▶
 - 3 = RAL 9003 white
 - 5 = RAL 9005 black
 - 6 = RAL 9006 alu
- REFLECTOR PLATE** ▶ Opal diffuser
- ADJUSTABLE** ▶ No
- SIZE** ▶ 900 X 112MM

OPTIONS

- COLORS** ▶ Available in all RAL colours on request
Additional price + 10%
- DIMMABLE** ▶ Dimmable or dali € 45,00
- PENDENT** ▶ Also available as a pendent version on req.

INFORMATION

- WARRANTY** ▶ 5 Years

Δ see colors

Keylight International B.V. reserves the right to modify or change technical, construction or LED specifications due to continuous improvements of our products and lightsources.



ORBIT 90

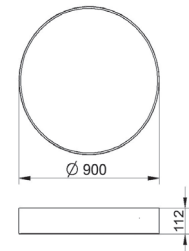

Technical drawing

| ARTICLE NO. | LAMP TYPE | BRAND | LIGHT OUTPUT | MODULE POWER | MODULE EFFICIENCY | CORRELATED COLOUR TEMPERATURE | COLOUR RENDERING INDEX | TC LIFE | SALES PRICE |
|--------------|-----------|---------|--------------|--------------|-------------------|-------------------------------|------------------------|---------|-------------|
| Δ see colors | | | LM | W | LM/W | K | RA | HRS | EURO |
| 5900.193.91Δ | LEDLine | Philips | 10.000 | 80 | 125 | 3000 | >80 | 50.000 | € 1050,00 |
| 5900.194.91Δ | LEDLine | Philips | 10.000 | 80 | 125 | 4000 | >80 | 50.000 | € 1050,00 |



Surface Square



BUXX
PAGE 1



BOXX 8
PAGE 1



JAZZ 16
PAGE 1

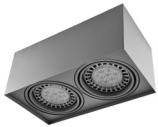

JAZZ 32
PAGE 1



QUBEE 40
PAGE 1



QUBEE 60
PAGE 1



BLOOP 60
PAGE 1

Surface Square

| | |
|-----------|--------|
| UTAH 18 | PAGE 1 |
| YORK | PAGE 1 |
| DL 180 | PAGE 1 |
| KANSAS 16 | PAGE 1 |
| DEEP 22 | PAGE 1 |
| VISION 15 | PAGE 1 |
| VISION 20 | PAGE 1 |

TECHNICAL INFORMATION

PRODUCT

BUXX



- PRODUCT MATERIAL** ▶ Aluminium
- LIGHT SOURCE** ▶ MR16 LED / LMR50
- DRIVER** ▶ LMR 50 includes a driver
- COLORS (Δ)** ▶
 - 3 = RAL 9003
 - 5 = RAL 9005
 - 6 = RAL 9006
- BEAM ANGLE** ▶ LMR: 20° / 30°
- ADJUSTABLE** ▶ Yes
- SIZE** ▶ 96 X 120MM

OPTIONS LMR

- DIMMABLE DRIVER IN COMBINATION WITH TUBE** ▶
 - OSRAM 8.5W 1/10v 350mA € 23,50
art. no.: 0110.999.99.0
 - OSRAM 13W phase-cut 350 mA € 23,50
art. no.: 0111.999.99.0
- OPTIONAL FRONT RING** ▶ LMR50 Aluminium colour. € 3,95
art. no.: 0052.999.99.6
- MOUNTING BRACKET** ▶ LMR50 incl. mounting set € 5,00
art. no.: 0051.999.99.5
- GLASS COVER CLEAR** ▶ LMR50 glass IP44 € 3,85
art. no.: 0053.999.99.0

INFORMATION

- WARRANTY** ▶ 5 Years
- Δ see colors

Keylight International B.V. reserves the right to modify or change technical, construction or LED specifications due to continuous improvements of our products and lightsources.



BUXX

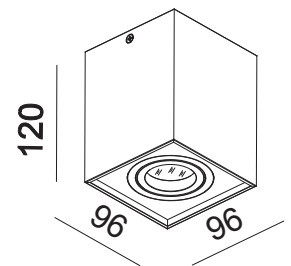

Technical drawing



LMR50

| ARTICLE NO. | LAMP TYPE | BRAND | LIGHT OUTPUT | MODULE POWER | MODULE EFFICIENCY | CORRELATED COLOUR TEMPERATURE | COLOUR RENDERING INDEX | TC LIFE | REFL. | mA | SALES PRICE |
|----------------|-----------|-----------|--------------|--------------|-------------------|-------------------------------|------------------------|---------|--------|-----|-------------|
| Δ see colors | | | LM | W | LM/W | K | RA | HRS | DEGREE | mA | EURO |
| ! 5125.999.99Δ | Gu5.3 | | | Max. 50W | | | | | | | € 45,00 |
| ! 5125.999.99Δ | Gu10 | | | Max. 50W | | | | | | | € 45,00 |
| 5125.171.20Δ | LMR50 | Bridgelux | 560 | 6.6 | 79 | 2700 | >80 | 25.000 | 20° | 350 | € 85,00 |
| 5125.172.30Δ | LMR50 | Bridgelux | 560 | 6.6 | 79 | 2700 | >80 | 25.000 | 30° | 350 | € 85,00 |
| 5125.173.20Δ | LMR50 | Bridgelux | 600 | 6.6 | 86 | 3000 | >80 | 25.000 | 20° | 350 | € 85,00 |
| 5125.174.30Δ | LMR50 | Bridgelux | 600 | 6.6 | 86 | 3000 | >80 | 25.000 | 30° | 350 | € 85,00 |

TECHNICAL INFORMATION

PRODUCT

BOXX 8



- PRODUCT MATERIAL** ▶ Aluminium
- LIGHT SOURCE** ▶ DISK G3
- MODULE LIFETIME** ▶ Approx. 50.000 hours
- LED COOLING** ▶ Passive cooling
- DRIVER** ▶ Incl. Integrated driver.
- COLORS (Δ)** ▶
 - 3 = RAL 9003 white
 - 5 = RAL 9005 black
 - 6 = RAL 9006 alu
- BEAM ANGLE** ▶ 85°
- ADJUSTABLE** ▶ No
- SIZE** ▶ 100 X 128MM

OPTIONS

- COLORS** ▶ Available in all RAL colours on request.
Additional price + 10%
- DIMMABLE** ▶ Standard Dimmable leading edge

INFORMATION

- WARRANTY** ▶ 5 Years

Δ = product color code. See colors

Keylight International B.V. reserves the right to modify or change technical, construction or LED specifications due to continuous improvements of our products and lightsources.



BOXX 8

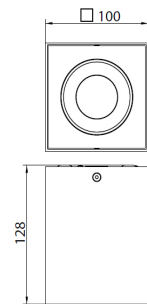

Technical drawing

| ARTICLE NO. | LAMP TYPE | BRAND | LIGHT OUTPUT | MODULE POWER | MODULE EFFICIENCY | CORRELATED COLOUR TEMPERATURE | COLOUR RENDERING INDEX | TC LIFE | POWER FACTOR | SALES PRICE |
|--------------|-----------|---------|--------------|--------------|-------------------|-------------------------------|------------------------|---------|--------------|-------------|
| Δ see colors | | | LM | W | LM/W | K | RA | HRS | PF | EURO |
| 5108.141.85Δ | Disk G3 | Philips | 800 | 12 | 68 | 2700 | >80 | 50.000 | >,09 | € 130,00 |
| 5108.142.85Δ | Disk G3 | Philips | 800 | 12 | 68 | 3000 | >80 | 50.000 | >,09 | € 130,00 |
| 5108.143.85Δ | Disk G3 | Philips | 850 | 11 | 72 | 4000 | >80 | 50.000 | >,09 | € 130,00 |

TECHNICAL INFORMATION

PRODUCT

JAZZ 16



- PRODUCT MATERIAL** ▶ Steel and aluminium
- LIGHT SOURCE** ▶ MasterSpot AR111
- DRIVER** ▶ not included
- COLORS (Δ)** ▶
 - 3 = RAL 9003 white
 - 5 = RAL 9005 black
 - 6 = RAL 9006 alu
- ADJUSTABLE** ▶ Yes
- SIZE** ▶ 160 X 160 X 130MM

OPTIONS

- COLORS** ▶ Available in all RAL colours on request.
Additional price + 10%
- DIMMABLE** ▶ Standard Dimmable leading edge

INFORMATION

- WARRANTY** ▶ 5 Years

Δ = product color code. See colors

! Including LED spot AR111

Keylight International B.V. reserves the right to modify or change technical, construction or LED specifications due to continuous improvements of our products and lightsources.



JAZZ 16

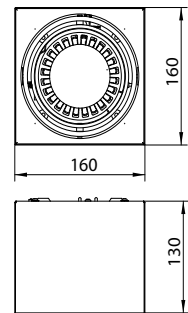

Technical drawing

| ARTICLE NO. | LAMP TYPE | BRAND | LIGHT OUTPUT | MODULE POWER | MODULE EFFICIENCY | CORRELATED COLOUR TEMPERATURE | COLOUR RENDERING INDEX | TC LIFE | REFL. | SALES PRICE |
|--------------|-----------|---------|--------------|--------------|-------------------|-------------------------------|------------------------|---------|--------|-------------|
| Δ see colors | | | LM | W | LM/W | K | RA | HRS | DEGREE | EURO |
| 5102.606.24Δ | AR111 | Philips | 610 | 10 | 50 | 2700 | >80 | 45.000 | 24° | € 245,00 |
| 5102.606.40Δ | AR111 | Philips | 580 | 10 | 50 | 2700 | >80 | 45.000 | 40° | € 245,00 |
| 5102.606.24Δ | AR111 | Philips | 645 | 10 | 50 | 3000 | >80 | 45.000 | 24° | € 245,00 |
| 5102.606.40Δ | AR111 | Philips | 610 | 10 | 50 | 3000 | >80 | 45.000 | 40° | € 245,00 |
| 5102.606.24Δ | AR111 | Philips | 800 | 15 | 50 | 2700 | >80 | 45.000 | 24° | € 245,00 |
| 5102.606.40Δ | AR111 | Philips | 760 | 15 | 50 | 2700 | >80 | 45.000 | 40° | € 245,00 |
| 5102.606.24Δ | AR111 | Philips | 840 | 15 | 50 | 3000 | >80 | 45.000 | 24° | € 245,00 |
| 5102.606.40Δ | AR111 | Philips | 800 | 15 | 50 | 3000 | >80 | 45.000 | 40° | € 245,00 |

TECHNICAL INFORMATION

PRODUCT

JAZZ 32



- PRODUCT MATERIAL** ▶ Steel and aluminium
- LIGHT SOURCE** ▶ MasterSpot AR111
- DRIVER** ▶ not included
- COLORS (Δ)** ▶
 - 3 = RAL 9003 white
 - 5 = RAL 9005 black
 - 6 = RAL 9006 alu
- ADJUSTABLE** ▶ Yes
- SIZE** ▶ 317 X 160 X 130MM

OPTIONS

- COLORS** ▶ Available in all RAL colours on request.
Additional price + 10%
- DIMMABLE** ▶ Standard Dimmable leading edge

INFORMATION

- WARRANTY** ▶ 5 Years

Δ = product color code. See colors

! Including LED spot AR111

Keylight International B.V. reserves the right to modify or change technical, construction or LED specifications due to continuous improvements of our products and lightsources.



JAZZ 32

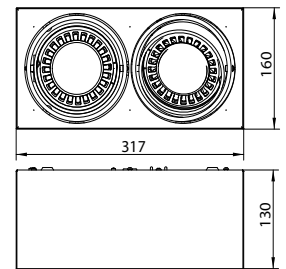

Technical drawing

| ARTICLE NO. | LAMP TYPE | BRAND | LIGHT OUTPUT | MODULE POWER | MODULE EFFICIENCY | CORRELATED COLOUR TEMPERATURE | COLOUR RENDERING INDEX | TC LIFE | REFL. | SALES PRICE |
|--------------|-----------|---------|--------------|--------------|-------------------|-------------------------------|------------------------|---------|--------|-------------|
| Δ see colors | | | LM | W | LM/W | K | RA | HRS | DEGREE | EURO |
| 5103.606.24Δ | AR111 | Philips | 2X 610 | 2X 10 | 2X 50 | 2X 2700 | >80 | 45.000 | 24° | € 420,00 |
| 5103.606.40Δ | AR111 | Philips | 2X 580 | 2X 10 | 2X 50 | 2X 2700 | >80 | 45.000 | 40° | € 420,00 |
| 5103.606.24Δ | AR111 | Philips | 2X 645 | 2X 10 | 2X 50 | 2X 3000 | >80 | 45.000 | 24° | € 420,00 |
| 5103.606.40Δ | AR111 | Philips | 2X 610 | 2X 10 | 2X 50 | 2X 3000 | >80 | 45.000 | 40° | € 420,00 |
| 5103.606.24Δ | AR111 | Philips | 2X 800 | 2X 15 | 2X 50 | 2X 2700 | >80 | 45.000 | 24° | € 420,00 |
| 5103.606.40Δ | AR111 | Philips | 2X 760 | 2X 15 | 2X 50 | 2X 2700 | >80 | 45.000 | 40° | € 420,00 |
| 5103.606.24Δ | AR111 | Philips | 2X 840 | 2X 15 | 2X 50 | 2X 3000 | >80 | 45.000 | 24° | € 420,00 |
| 5103.606.40Δ | AR111 | Philips | 2X 800 | 2X 15 | 2X 50 | 2X 3000 | >80 | 45.000 | 40° | € 420,00 |

TECHNICAL INFORMATION

PRODUCT

QUBEE 40



- PRODUCT MATERIAL** ▶ Steel and aluminium
- LIGHT SOURCE** ▶ Ledline
- MODULE LIFETIME** ▶ Approx. 50.000 hours
- LED COOLING** ▶ Passive cooling
- DRIVER LEDPLATE** ▶ Incl. standard xitanium driver.
- COLORS (Δ)** ▶
 - 3 = RAL 9003 white
 - 5 = RAL 9005 black
 - 6 = RAL 9006 alu
- REFLECTOR PLATE** ▶ Opal diffuser
- ADJUSTABLE** ▶ No
- SIZE** ▶ 390 X 390 X 100MM

OPTIONS

- COLORS** ▶ Available in all RAL colours on request
Additional price + 10%
- DIMMABLE** ▶ Dimmable or dali € 45,00

INFORMATION

- WARRANTY** ▶ 5 Years

Δ see colors

Keylight International B.V. reserves the right to modify or change technical, construction or LED specifications due to continuous improvements of our products and lightsources.



QUBEE 40

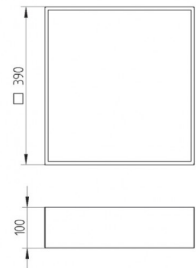

Technical drawing

| ARTICLE NO. | LAMP TYPE | BRAND | LIGHT OUTPUT | MODULE POWER | MODULE EFFICIENCY | CORRELATED COLOUR TEMPERATURE | COLOUR RENDERING INDEX | TC LIFE | SALES PRICE |
|--------------|-----------|---------|--------------|--------------|-------------------|-------------------------------|------------------------|---------|-------------|
| Δ see colors | | | LM | W | LM/W | K | RA | HRS | EURO |
| 5391.195.91Δ | Ledline | Philips | 2600 | 19 | 136 | 3000 | >80 | 50.000 | € 315,00 |
| 5391.196.91Δ | Ledline | Philips | 2600 | 19 | 136 | 4000 | >80 | 50.000 | € 315,00 |
| 5391.197.91Δ | Ledline | Philips | 4400 | 33 | 133 | 3000 | >80 | 50.000 | € 315,00 |
| 5391.198.91Δ | Ledline | Philips | 4400 | 33 | 133 | 4000 | >80 | 50.000 | € 315,00 |

TECHNICAL INFORMATION

PRODUCT

QUBEE 60



- PRODUCT MATERIAL** ▶ Steel and aluminium
- LIGHT SOURCE** ▶ Ledline
- MODULE LIFETIME** ▶ Approx. 50.000 hours
- LED COOLING** ▶ Passive cooling
- DRIVER LEDPLATE** ▶ Incl. standard titanium driver.
- COLORS (Δ)** ▶
 - 3 = RAL 9003 white
 - 5 = RAL 9005 black
 - 6 = RAL 9006 alu
- REFLECTOR PLATE** ▶ Opal diffuser
- ADJUSTABLE** ▶ No
- SIZE** ▶ 600 X 600 X 100MM

OPTIONS

- COLORS** ▶ Available in all RAL colours on request
Additional price + 10%
- DIMMABLE** ▶ Dimmable or dali € 45,00

INFORMATION

- WARRANTY** ▶ 5 Years

Δ see colors

Keylight International B.V. reserves the right to modify or change technical, construction or LED specifications due to continuous improvements of our products and lightsources.



QUBEE 60

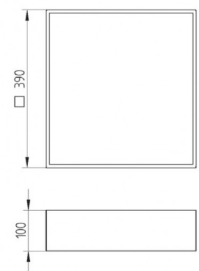

Technical drawing

| ARTICLE NO. | LAMP TYPE | BRAND | LIGHT OUTPUT | MODULE POWER | MODULE EFFICIENCY | CORRELATED COLOUR TEMPERATURE | COLOUR RENDERING INDEX | TC LIFE | SALES PRICE |
|--------------|-----------|---------|--------------|--------------|-------------------|-------------------------------|------------------------|---------|-------------|
| Δ see colors | | | LM | W | LM/W | K | RA | HRS | EURO |
| 5600.195.91Δ | Ledline | Philips | 5000 | 40 | 125 | 3000 | >80 | 50.000 | € 380,00 |
| 5600.196.91Δ | Ledline | Philips | 5000 | 40 | 125 | 4000 | >80 | 50.000 | € 380,00 |
| 5600.193.91Δ | Ledline | Philips | 10.000 | 69 | 145 | 3000 | >80 | 50.000 | € 770,00 |
| 5600.194.91Δ | Ledline | Philips | 10.000 | 69 | 145 | 4000 | >80 | 50.000 | € 770,00 |

TECHNICAL INFORMATION

PRODUCT

BLOOP 60



- PRODUCT MATERIAL** ▶ Steel and aluminium
- LIGHT SOURCE** ▶ Ledline
- MODULE LIFETIME** ▶ Approx. 50.000 hours
- LED COOLING** ▶ Passive cooling
- DRIVER LEDPLATE** ▶ Incl. standard xitanium driver.
- COLORS (Δ)** ▶
 - 3 = RAL 9003 white
 - 5 = RAL 9005 black
 - 6 = RAL 9006 alu
- REFLECTOR PLATE** ▶ Opal diffuser
- ADJUSTABLE** ▶ No
- SIZE** ▶ 635 X 635 X 100MM

OPTIONS

- COLORS** ▶ Available in all RAL colours on request
Additional price + 10%
- DIMMABLE** ▶ Dimmable or dali € 45,00

INFORMATION

- WARRANTY** ▶ 5 Years

Δ see colors

Keylight International B.V. reserves the right to modify or change technical, construction or LED specifications due to continuous improvements of our products and lightsources.



BLOOP 60

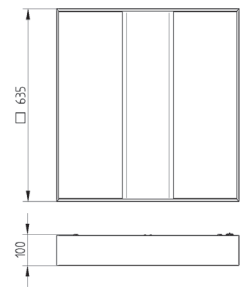

Technical drawing

| ARTICLE NO. | LAMP TYPE | BRAND | LIGHT OUTPUT | MODULE POWER | MODULE EFFICIENCY | CORRELATED COLOUR TEMPERATURE | COLOUR RENDERING INDEX | TC LIFE | SALES PRICE |
|--------------|-----------|---------|--------------|--------------|-------------------|-------------------------------|------------------------|---------|-------------|
| Δ see colors | | | LM | W | LM/W | K | RA | HRS | EURO |
| 5155.195.91Δ | Ledline | Philips | 2600 | 19 | 136 | 3000 | >80 | 50.000 | € 295,00 |
| 5155.196.91Δ | Ledline | Philips | 2600 | 19 | 136 | 4000 | >80 | 50.000 | € 295,00 |
| 5155.197.91Δ | Ledline | Philips | 4400 | 33 | 133 | 3000 | >80 | 50.000 | € 295,00 |
| 5155.198.91Δ | Ledline | Philips | 4400 | 33 | 133 | 4000 | >80 | 50.000 | € 295,00 |

Keylight International B.V. reserves the right to modify or change technical, construction or LED specifications due to continuous improvements of our products and lightsources.



G-STAR RAW



Track
Lighting





PRODUCT MATERIAL
PAGE 1



LEDIMO 10
PAGE 1



LEDIMO 20
PAGE 1



LARGO
PAGE 1



MONDI
PAGE 1



FOLLOW
PAGE 1



STREAM LED
PAGE 1



SOYUZ
PAGE 1



TWIN
PAGE 1



BUZZA
PAGE 1



DRUM
PAGE 1



FORCE
PAGE 1



DAXX
PAGE 1



ARTI
PAGE 1



COLT 14
PAGE 1

Track Lighting

| | |
|------------|--------|
| UTAH 18 | PAGE 1 |
| YORK | PAGE 1 |
| DL 180 | PAGE 1 |
| KANSAS 16 | PAGE 1 |
| DEEP 22 | PAGE 1 |
| VISION 15 | PAGE 1 |
| VISION 20 | PAGE 1 |
| ROLED | PAGE 1 |
| CAP R1 | PAGE 1 |
| CAP R2 | PAGE 1 |
| LINKON 13 | PAGE 1 |
| LINKON 14L | PAGE 1 |
| UTAH 22 | PAGE 1 |
| UTAH 18 | PAGE 1 |
| YORK | PAGE 1 |

TECHNICAL INFORMATION

PRODUCT

ORCUS



- PRODUCT MATERIAL** ▶ Aluminium
- ADAPTER** ▶ 1-phase track adapter
- LIGHT SOURCE** ▶ Samsung
- MODULE LIFETIME** ▶ Approx. 15.000 hours
- LED COOLING** ▶ Passive cooling
- DRIVER** ▶ Not needed. Direct 230V
- COLORS (Δ)** ▶
 - 3 = RAL 9003 white
 - 5 = RAL 9005 black
 - 6 = RAL 9006 ALU
- BEAM ANGLE** ▶ 24°
- ADJUSTABLE** ▶ Horizontally and vertically rotational
- SIZE** ▶ 141 X 50MM

OPTIONS

- MONO POINT** ▶ To fix the track light to the ceiling or wall.
Color 3 - 5 - 6 € 28,50

INFORMATION

- WARRANTY** ▶ 3 Years

Δ = product color code. See colors

Not dimmable

Keylight International B.V. reserves the right to modify or change technical, construction or LED specifications due to continuous improvements of our products and lightsources.



ORCUS

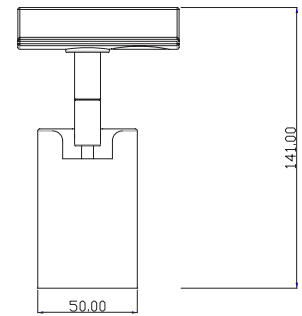

Technical drawing

| ARTICLE NO. | LAMP TYPE | BRAND | LIGHT OUTPUT | MODULE POWER | MODULE EFFICIENCY | CORRELATED COLOUR TEMPERATURE | COLOUR RENDERING INDEX | TC LIFE | ADAPTER | SALES PRICE |
|--------------|-----------|---------|--------------|--------------|-------------------|-------------------------------|------------------------|---------|---------|-------------|
| Δ see colors | | | LM | W | LM/W | K | RA | HRS | | EURO |
| 3040.999.24Δ | LED | SAMSUNG | 310 | 5 | 62 | 2700 | >80 | 25.000 | 1-phase | € 60,00 |

TECHNICAL INFORMATION

PRODUCT

ORCUS LONG



- PRODUCT MATERIAL** ▶ Aluminium
- ADAPTER** ▶ 1-phase track adapter
- LIGHT SOURCE** ▶ Samsung
- MODULE LIFETIME** ▶ Approx. 15.000 hours
- LED COOLING** ▶ Passive cooling
- DRIVER** ▶ Not needed. Direct 230V
- COLORS (Δ)** ▶
 - 3 = RAL 9003 white
 - 5 = RAL 9005 black
 - 6 = RAL 9006 ALU
- BEAM ANGLE** ▶ 24°
- ADJUSTABLE** ▶ Horizontally and vertically rotational
- SIZE** ▶ 187 X 50MM

OPTIONS

- MONO POINT** ▶ To fix the track light to the ceiling or wall.
Color 3 - 5 - 6 € 28,50

INFORMATION

- WARRANTY** ▶ 3 Years

Δ = product color code. See colors

Not dimmable

Keylight International B.V. reserves the right to modify or change technical, construction or LED specifications due to continuous improvements of our products and light sources.



ORCUS LONG

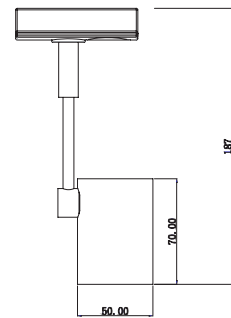

Technical drawing

| ARTICLE NO. | LAMP TYPE | BRAND | LIGHT OUTPUT | MODULE POWER | MODULE EFFICIENCY | CORRELATED COLOUR TEMPERATURE | COLOUR RENDERING INDEX | TC LIFE | ADAPTER | SALES PRICE |
|--------------|-----------|---------|--------------|--------------|-------------------|-------------------------------|------------------------|---------|---------|-------------|
| Δ see colors | | | LM | W | LM/W | K | RA | HRS | | EURO |
| 3041.999.24Δ | LED | SAMSUNG | 310 | 5 | 62 | 2700 | >80 | 25.000 | 1-phase | € 65,00 |

Keylight International B.V. reserves the right to modify or change technical, construction or LED specifications due to continuous improvements of our products and lightsources.

TECHNICAL INFORMATION

PRODUCT

LEDIMO 5



- PRODUCT MATERIAL** ▶ Die-cast aluminium
- ADAPTER** ▶ 3-phase track adapter
- LIGHT SOURCE** ▶ Fortimo SLM G4
- MODULE LIFETIME** ▶ Approx. 50.000 hours
- LED COOLING** ▶ Passive cooling
- DRIVER** ▶ Incl. titanium driver
- COLORS (Δ)** ▶
 - 3 = RAL 9003 white
 - 5 = RAL 9005 black
 - 6 = RAL 9006 alu
- BEAM ANGLE** ▶ 24°
- ADJUSTABLE** ▶ Horizontally and vertically rotational
- SIZE** ▶ 203 X 263MM

OPTIONS

- OPTIONAL BEAM ANGLE** ▶ 36° € 5,00
- MONO POINT** ▶ To fix the track light to the ceiling or wall.
Color 3 - 5 - 6 € 28,50

INFORMATION

- REFLECTOR RING** ▶ Standard black
- WARRANTY** ▶ 5 Years

Δ = product color code. See colors
Long-life patented LED cooling system.

Keylight International B.V. reserves the right to modify or change technical, construction or LED specifications due to continuous improvements of our products and lightsources.



LEDIMO 5

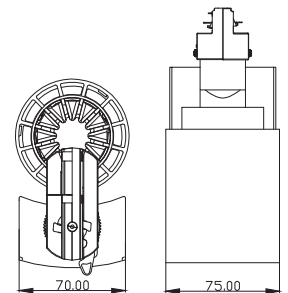

Technical drawing

| ARTICLE NO. | LAMP TYPE | BRAND | LIGHT OUTPUT | MODULE POWER | SETTING * | MODULE EFFICIENCY | CORRELATED COLOUR TEMPERATURE | COLOUR RENDERING INDEX | B50/L70 AT TC LIFE | SALES PRICE |
|---------------|--------------------|---------|--------------|--------------|-----------------|-------------------|-------------------------------|------------------------|--------------------|-------------|
| Δ see colors | GEN 4 | | LM | W | | LM/W | K | RA | HRS | EURO |
| 3021.111.24.Δ | SLM 1100-827 L13 # | Philips | 1160 | 10 | High Efficiency | 114 | 2700 | >82 | 50.000 | € 150,00 |
| 3021.112.24.Δ | SLM 1100-830 L13 | Philips | 1240 | 10 | High Efficiency | 122 | 3000 | >82 | 50.000 | € 150,00 |
| 3021.113.24.Δ | SLM 1100-840 L13 | Philips | 1330 | 10 | High Efficiency | 130 | 4000 | >82 | 50.000 | € 150,00 |
| 3021.114.24.Δ | SLM 2000-830 L13 | Philips | 2020 | 17 | High Efficiency | 117 | 3000 | >82 | 50.000 | € 155,00 |
| 3021.116.24.Δ | SLM 2000-840 L13 | Philips | 2150 | 17 | High Efficiency | 124 | 4000 | >82 | 50.000 | € 155,00 |
| 3021.125.24.Δ | SLM 2000-927 L13 # | Philips | 1570 | 17 | High Efficiency | 91 | 2700 | >97 | 50.000 | € 160,00 |
| 3021.120.24.Δ | SLM 2000-930 L13 | Philips | 1650 | 17 | High Efficiency | 95 | 3000 | >97 | 50.000 | € 160,00 |

* SLM G4: High efficacy is Keylight standard, High value: option for more Lumen flux output (more power, more watt) option on request.
 # SLM 827 + 927, On special request
 - SLM Premium White (colour point bBBL) 2000 Lm / 4500 Lm 3000k, On special request

TECHNICAL INFORMATION

PRODUCT

LEDIMO 10



- PRODUCT MATERIAL** ▶ Die-cast aluminium
- ADAPTER** ▶ 3-phase track adapter
- LIGHT SOURCE** ▶ Fortimo SLM G4
- MODULE LIFETIME** ▶ Approx. 50.000 hours
- LED COOLING** ▶ Passive cooling
- DRIVER** ▶ Incl. titanium driver
- COLORS (Δ)** ▶
 - 3 = RAL 9003 white
 - 5 = RAL 9005 black
 - 6 = RAL 9006 alu
- BEAM ANGLE** ▶ 24°
- ADJUSTABLE** ▶ Horizontally and vertically rotational
- SIZE** ▶ 203 X 263MM

OPTIONS

- OPTIONAL BEAM ANGLE** ▶ 12° / 36° € 5,00
- DIMMABLE** ▶ Dimmable DALI € 75,00
- MONO POINT** ▶ To fix the track light to the ceiling or wall.
 - Color 3 - 5 - 6 € 28,50
- DIFFUSER** ▶ 0180.999.99 (frosted diffuser) € 7,50
- DIFFUSER W/ HOLE** ▶ 0185.999.99 (frosted diffuser) € 7,50

INFORMATION

- WARRANTY** ▶ 5 Years

Δ = product color code. See colors
Long-life patented LED cooling system.

Keylight International B.V. reserves the right to modify or change technical, construction or LED specifications due to continuous improvements of our products and lightsources.



LEDIMO 10

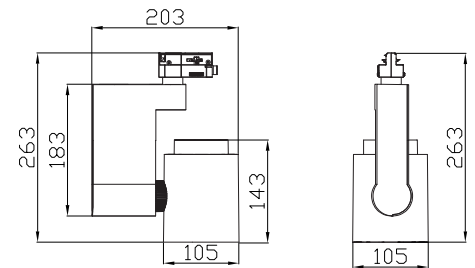

Technical drawing

| ARTICLE NO. | LAMP TYPE | BRAND | LIGHT OUTPUT | MODULE POWER | SETTING * | MODULE EFFICIENCY | CORRELATED COLOUR TEMPERATURE | COLOUR RENDERING INDEX | B50/L70 AT TC LIFE | SALES PRICE |
|---------------|---------------------|---------|--------------|--------------|------------------|-------------------|-------------------------------|------------------------|--------------------|-------------|
| Δ see colors | GEN 4 | | LM | W | | LM/W | K | RA | HRS | EURO |
| 3021.111.24.Δ | SLM 1100-827 L13 # | Philips | 1160 | 10 | High Efficiency | 114 | 2700 | >82 | 50.000 | € 165,00 |
| 3021.112.24.Δ | SLM 1100-830 L13 | Philips | 1240 | 10 | High Efficiency | 122 | 3000 | >82 | 50.000 | € 165,00 |
| 3021.113.24.Δ | SLM 1100-840 L13 | Philips | 1330 | 10 | High Efficiency | 130 | 4000 | >82 | 50.000 | € 165,00 |
| 3021.114.24.Δ | SLM 2000-830 L13 | Philips | 2020 | 17 | High Efficiency | 117 | 3000 | >82 | 50.000 | € 175,00 |
| 3021.116.24.Δ | SLM 2000-840 L13 | Philips | 2150 | 17 | High Efficiency | 124 | 4000 | >82 | 50.000 | € 175,00 |
| 3021.125.24.Δ | SLM 2000-927 L13 # | Philips | 1570 | 17 | High Efficiency | 91 | 2700 | >97 | 50.000 | € 180,00 |
| 3021.120.24.Δ | SLM 2000-930 L13 | Philips | 1650 | 17 | High Efficiency | 95 | 3000 | >97 | 50.000 | € 180,00 |
| 3021.117.24.Δ | SLM 3000-830 L15 | Philips | 2970 | 26 | High Efficiency | 114 | 3000 | >82 | 50.000 | € 185,00 |
| 3021.119.24.Δ | SLM 3000-840 L15 | Philips | 3170 | 26 | High Efficiency | 122 | 4000 | >82 | 50.000 | € 185,00 |
| 3021.128.24.Δ | SLM 3000-927 L15 # | Philips | 2320 | 26 | High Efficiency | 89 | 2700 | >97 | 50.000 | € 190,00 |
| 3021.121.24.Δ | SLM 3000-930 L15 | Philips | 2400 | 26 | High Efficiency | 92 | 3000 | >97 | 50.000 | € 190,00 |
| 3021.135.24.Δ | SLM 4500-830 L19 | Philips | 4860 | 42 | High Efficiency | 114 | 3000 | >82 | 50.000 | € 225,00 |
| 3021.136.24.Δ | SLM 4500-840 L19 | Philips | 5160 | 42 | High Efficiency | 122 | 4000 | >82 | 50.000 | € 225,00 |
| 3021.157.24.Δ | SLM 4500-927 L19 | Philips | 3760 | 42 | High Efficiency | 89 | 2700 | >97 | 50.000 | € 230,00 |
| 3021.137.24.Δ | SLM 4500-930 L19 | Philips | 3930 | 42 | High Efficiency | 92 | 3000 | >97 | 50.000 | € 230,00 |
| 3021.109.24.Δ | SLM CW 3000-930 L15 | Philips | 2790 | 34 | Crisp White | 82 | 3000 | >92 | 50.000 | €195,00 |
| 3021.110.24.Δ | SLM CW 3800-930 L19 | Philips | 2790 | 34 | Crisp White | 82 | 3000 | >92 | 50.000 | € 235,00 |
| 3021.159.24.Δ | SLM FW 2800-925 L19 | Philips | 2880 | 42 | Food Warm White | 69 | 2900 | >90 | 50.000 | € 250,00 |
| 3021.160.24.Δ | SLM FR 3000-930 L19 | Philips | 2980 | 42 | Food Premium red | 72 | 3150 | >87 | 50.000 | € 250,00 |

* SLM G4: High efficacy is Keylight standard. High value: option for more Lumen flux output (more power, more watt) option on request.
 # SLM 827 + 927, On special request
 - SLM Premium White (colour point bBBL) 2000 Lm / 4500 Lm 3000k, On special request

TECHNICAL INFORMATION

PRODUCT

LEDIMO 20



- PRODUCT MATERIAL** ▶ Die-cast aluminium
- ADAPTER** ▶ 3-phase track adapter
- LIGHT SOURCE** ▶ Fortimo SLM G4
- MODULE LIFETIME** ▶ Approx. 50.000 hours
- LED COOLING** ▶ Passive cooling
- DRIVER** ▶ Incl. titanium driver
- COLORS (Δ)** ▶
 - 3 = RAL 9003 white
 - 5 = RAL 9005 black
 - 6 = RAL 9006 alu
- BEAM ANGLE** ▶ 24°
- ADJUSTABLE** ▶ Horizontally and vertically rotational
- SIZE** ▶ 231 X 172MM

OPTIONS

- OPTIONAL BEAM ANGLE** ▶ 12° / 36° € 5,00
- MONO POINT** ▶ To fix the track light to the ceiling or wall.
Color 3 - 5 - 6 € 28,50
- DIFFUSER** ▶ 0180.999.99 (frosted diffuser) € 7,50
- DIFFUSER W/ HOLE** ▶ 0185.999.99 (frosted diffuser) € 7,50

INFORMATION

- WARRANTY** ▶ 5 Years

Δ = product color code. See colors
Long-life patented LED cooling system.

Keylight International B.V. reserves the right to modify or change technical, construction or LED specifications due to continuous improvements of our products and light sources.



LEDIMO 20

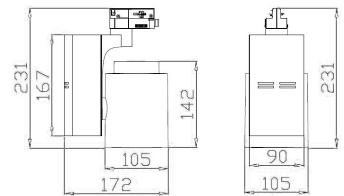

Technical drawing

| ARTICLE NO. | LAMP TYPE | BRAND | LIGHT OUTPUT | MODULE POWER | SETTING * | MODULE EFFICIENCY | CORRELATED COLOUR TEMPERATURE | COLOUR RENDERING INDEX | B50/L70 AT TC LIFE | SALES PRICE |
|---------------|---------------------|---------|--------------|--------------|------------------|-------------------|-------------------------------|------------------------|--------------------|-------------|
| Δ see colors | GEN 4 | | LM | W | | LM/W | K | RA | HRS | EURO |
| 3020.111.24.Δ | SLM 1100-827 L13 # | Philips | 1160 | 10 | High Efficiency | 114 | 2700 | >82 | 50.000 | € 165,00 |
| 3020.112.24.Δ | SLM 1100-830 L13 | Philips | 1240 | 10 | High Efficiency | 122 | 3000 | >82 | 50.000 | € 165,00 |
| 3020.113.24.Δ | SLM 1100-840 L13 | Philips | 1330 | 10 | High Efficiency | 130 | 4000 | >82 | 50.000 | € 165,00 |
| 3020.114.24.Δ | SLM 2000-830 L13 | Philips | 2020 | 17 | High Efficiency | 117 | 3000 | >82 | 50.000 | € 175,00 |
| 3020.116.24.Δ | SLM 2000-840 L13 | Philips | 2150 | 17 | High Efficiency | 124 | 4000 | >82 | 50.000 | € 175,00 |
| 3020.125.24.Δ | SLM 2000-927 L13 # | Philips | 1570 | 17 | High Efficiency | 91 | 2700 | >97 | 50.000 | € 180,00 |
| 3020.120.24.Δ | SLM 2000-930 L13 | Philips | 1650 | 17 | High Efficiency | 95 | 3000 | >97 | 50.000 | € 180,00 |
| 3020.117.24.Δ | SLM 3000-830 L15 | Philips | 2970 | 26 | High Efficiency | 114 | 3000 | >82 | 50.000 | € 185,00 |
| 3020.119.24.Δ | SLM 3000-840 L15 | Philips | 3170 | 26 | High Efficiency | 122 | 4000 | >82 | 50.000 | € 185,00 |
| 3020.128.24.Δ | SLM 3000-927 L15 # | Philips | 2320 | 26 | High Efficiency | 89 | 2700 | >97 | 50.000 | € 190,00 |
| 3020.121.24.Δ | SLM 3000-930 L15 | Philips | 2400 | 26 | High Efficiency | 92 | 3000 | >97 | 50.000 | € 190,00 |
| 3020.135.24.Δ | SLM 4500-830 L19 | Philips | 4860 | 42 | High Efficiency | 114 | 3000 | >82 | 50.000 | € 225,00 |
| 3020.136.24.Δ | SLM 4500-840 L19 | Philips | 5160 | 42 | High Efficiency | 122 | 4000 | >82 | 50.000 | € 225,00 |
| 3020.157.24.Δ | SLM 4500-927 L19 | Philips | 3760 | 42 | High Efficiency | 89 | 2700 | >97 | 50.000 | € 230,00 |
| 3020.137.24.Δ | SLM 4500-930 L19 | Philips | 3930 | 42 | High Efficiency | 92 | 3000 | >97 | 50.000 | € 230,00 |
| 3020.109.24.Δ | SLM CW 3000-930 L15 | Philips | 2790 | 34 | Crisp White | 82 | 3000 | >92 | 50.000 | € 195,00 |
| 3020.110.24.Δ | SLM CW 3800-930 L19 | Philips | 2790 | 34 | Crisp White | 82 | 3000 | >92 | 50.000 | € 235,00 |
| 3020.159.24.Δ | SLM FW 2800-925 L19 | Philips | 2880 | 42 | Food Warm White | 69 | 2900 | >90 | 50.000 | € 250,00 |
| 3020.160.24.Δ | SLM FR 3000-930 L19 | Philips | 2980 | 42 | Food Premium red | 72 | 3150 | >87 | 50.000 | € 250,00 |

* SLM G4: High efficacy is Keylight standard, High value: option for more Lumen flux output (more power, more watt) option on request.
 # SLM 827 + 927, On special request
 - SLM Premium White (colour point bBBL) 2000 Lm / 4500 Lm 3000k, On special request

TECHNICAL INFORMATION

PRODUCT

LARGO



- PRODUCT MATERIAL** ▶ Die-cast aluminium
- ADAPTER** ▶ 3-phase track adapter
- LIGHT SOURCE** ▶ Fortimo SLM G4
- MODULE LIFETIME** ▶ Approx. 50.000 hours
- LED COOLING** ▶ Passive cooling
- DRIVER** ▶ Incl. titanium driver
- COLORS (Δ)** ▶
 - 3 = RAL 9003 white
 - 5 = RAL 9005 black
 - 6 = RAL 9006 alu
- BEAM ANGLE** ▶ 24°
- ADJUSTABLE** ▶ Horizontally and vertically rotational
- SIZE** ▶ 232 X 110MM

OPTIONS

- OPTIONAL BEAM ANGLE** ▶ 12° / 36° € 5,00
- MONO POINT** ▶ To fix the track light to the ceiling or wall.
Color 3 - 5 - 6 € 28,50
- DIFFUSER** ▶ 0182.999.99 (frosted diffuser) € 7,50
- DIFFUSER W/ HOLE** ▶ 0184.999.99 (frosted diffuser) € 7,50

INFORMATION

- WARRANTY** ▶ 5 Years

Δ = product color code. See colors
Long-life patented LED cooling system.

Keylight International B.V. reserves the right to modify or change technical, construction or LED specifications due to continuous improvements of our products and lightsources.



LARGO

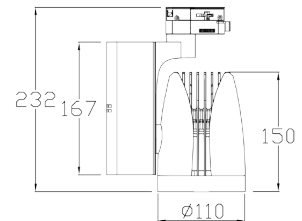

Technical drawing

| ARTICLE NO. | LAMP TYPE | BRAND | LIGHT OUTPUT | MODULE POWER | SETTING * | MODULE EFFICIENCY | CORRELATED COLOUR TEMPERATURE | COLOUR RENDERING INDEX | B50/L70 AT TC LIFE | SALES PRICE |
|---------------|---------------------|---------|--------------|--------------|------------------|-------------------|-------------------------------|------------------------|--------------------|-------------|
| Δ see colors | GEN 4 | | LM | W | | LM/W | K | RA | HRS | EURO |
| 3040.111.24.Δ | SLM 1100-827 L13 # | Philips | 1160 | 10 | High Efficiency | 114 | 2700 | >82 | 50.000 | € 175,00 |
| 3040.112.24.Δ | SLM 1100-830 L13 | Philips | 1240 | 10 | High Efficiency | 122 | 3000 | >82 | 50.000 | € 175,00 |
| 3040.113.24.Δ | SLM 1100-840 L13 | Philips | 1330 | 10 | High Efficiency | 130 | 4000 | >82 | 50.000 | € 175,00 |
| 3040.114.24.Δ | SLM 2000-830 L13 | Philips | 2020 | 17 | High Efficiency | 117 | 3000 | >82 | 50.000 | € 185,00 |
| 3040.116.24.Δ | SLM 2000-840 L13 | Philips | 2150 | 17 | High Efficiency | 124 | 4000 | >82 | 50.000 | € 185,00 |
| 3040.125.24.Δ | SLM 2000-927 L13 # | Philips | 1570 | 17 | High Efficiency | 91 | 2700 | >97 | 50.000 | € 190,00 |
| 3040.120.24.Δ | SLM 2000-930 L13 | Philips | 1650 | 17 | High Efficiency | 95 | 3000 | >97 | 50.000 | € 190,00 |
| 3040.117.24.Δ | SLM 3000-830 L15 | Philips | 2970 | 26 | High Efficiency | 114 | 3000 | >82 | 50.000 | € 195,00 |
| 3040.119.24.Δ | SLM 3000-840 L15 | Philips | 3170 | 26 | High Efficiency | 122 | 4000 | >82 | 50.000 | € 195,00 |
| 3040.128.24.Δ | SLM 3000-927 L15 # | Philips | 2320 | 26 | High Efficiency | 89 | 2700 | >97 | 50.000 | € 200,00 |
| 3040.121.24.Δ | SLM 3000-930 L15 | Philips | 2400 | 26 | High Efficiency | 92 | 3000 | >97 | 50.000 | € 200,00 |
| 3040.135.24.Δ | SLM 4500-830 L19 | Philips | 4860 | 42 | High Efficiency | 114 | 3000 | >82 | 50.000 | € 235,00 |
| 3040.136.24.Δ | SLM 4500-840 L19 | Philips | 5160 | 42 | High Efficiency | 122 | 4000 | >82 | 50.000 | € 235,00 |
| 3040.157.24.Δ | SLM 4500-927 L19 | Philips | 3760 | 42 | High Efficiency | 89 | 2700 | >97 | 50.000 | € 240,00 |
| 3040.137.24.Δ | SLM 4500-930 L19 | Philips | 3930 | 42 | High Efficiency | 92 | 3000 | >97 | 50.000 | € 240,00 |
| 3040.109.24.Δ | SLM CW 3000-930 L15 | Philips | 2790 | 34 | Crisp White | 82 | 3000 | >92 | 50.000 | € 205,00 |
| 3040.110.24.Δ | SLM CW 3800-930 L19 | Philips | 2790 | 34 | Crisp White | 82 | 3000 | >92 | 50.000 | € 245,00 |
| 3040.159.24.Δ | SLM FW 2800-925 L19 | Philips | 2880 | 42 | Food Warm White | 69 | 2900 | >90 | 50.000 | € 260,00 |
| 3040.160.24.Δ | SLM FR 3000-930 L19 | Philips | 2980 | 42 | Food Premium red | 72 | 3150 | >87 | 50.000 | € 260,00 |

* SLM G4: High efficacy is Keylight standard. High value: option for more Lumen flux output (more power, more watt) option on request.
 # SLM 827 + 927, On special request
 - SLM Premium White (colour point bBBL) 2000 Lm / 4500 Lm 3000k, On special request

TECHNICAL INFORMATION

PRODUCT

MONDI



- PRODUCT MATERIAL** ▶ Die-cast aluminium
- ADAPTER** ▶ 3-phase track adapter
- LIGHT SOURCE** ▶ Fortimo SLM G4
- MODULE LIFETIME** ▶ Approx. 50.000 hours
- LED COOLING** ▶ Passive cooling
- DRIVER** ▶ Incl. titanium driver
- COLORS (Δ)** ▶
 - 3 = RAL 9003 white
 - 5 = RAL 9005 black
 - 6 = RAL 9006 alu
- BEAM ANGLE** ▶ 24°
- ADJUSTABLE** ▶ Horizontally and vertically rotational
- SIZE** ▶ 117 X 240MM

OPTIONS

- OPTIONAL BEAM ANGLE** ▶ 12° / 36° € 5,00
- DIMMABLE** ▶ Dimmable DALI € 75,00
- MONO POINT** ▶ To fix the track light to the ceiling or wall.
 - Color 3 - 5 - 6 € 28,50
- DIFFUSER** ▶ 0182.999.99 (frosted diffuser) € 7,50
- DIFFUSER W/ HOLE** ▶ 0184.999.99 (frosted diffuser) € 7,50

INFORMATION

- WARRANTY** ▶ 5 Years

Δ = product color code. See colors

Keylight International B.V. reserves the right to modify or change technical, construction or LED specifications due to continuous improvements of our products and lightsources.



MONDI

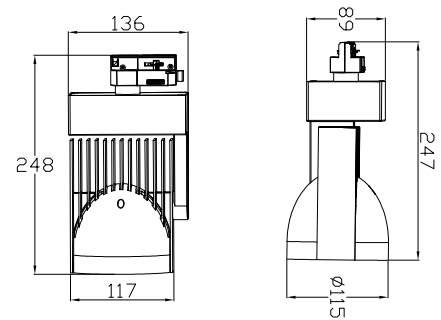

Technical drawing

| ARTICLE NO. | LAMP TYPE | BRAND | LIGHT OUTPUT | MODULE POWER | SETTING * | MODULE EFFICIENCY | CORRELATED COLOUR TEMPERATURE | COLOUR RENDERING INDEX | B50/L70 AT TC LIFE | SALES PRICE |
|---------------|---------------------|---------|--------------|--------------|------------------|-------------------|-------------------------------|------------------------|--------------------|-------------|
| Δ see colors | GEN 4 | | LM | W | | LM/W | K | RA | HRS | EURO |
| 3032.111.24.Δ | SLM 1100-827 L13 # | Philips | 1160 | 10 | High Efficiency | 114 | 2700 | >82 | 50.000 | € 170,00 |
| 3032.112.24.Δ | SLM 1100-830 L13 | Philips | 1240 | 10 | High Efficiency | 122 | 3000 | >82 | 50.000 | € 170,00 |
| 3032.113.24.Δ | SLM 1100-840 L13 | Philips | 1330 | 10 | High Efficiency | 130 | 4000 | >82 | 50.000 | € 170,00 |
| 3032.114.24.Δ | SLM 2000-830 L13 | Philips | 2020 | 17 | High Efficiency | 117 | 3000 | >82 | 50.000 | € 180,00 |
| 3032.116.24.Δ | SLM 2000-840 L13 | Philips | 2150 | 17 | High Efficiency | 124 | 4000 | >82 | 50.000 | € 180,00 |
| 3032.125.24.Δ | SLM 2000-927 L13 # | Philips | 1570 | 17 | High Efficiency | 91 | 2700 | >97 | 50.000 | € 185,00 |
| 3032.120.24.Δ | SLM 2000-930 L13 | Philips | 1650 | 17 | High Efficiency | 95 | 3000 | >97 | 50.000 | € 185,00 |
| 3032.117.24.Δ | SLM 3000-830 L15 | Philips | 2970 | 26 | High Efficiency | 114 | 3000 | >82 | 50.000 | € 190,00 |
| 3032.119.24.Δ | SLM 3000-840 L15 | Philips | 3170 | 26 | High Efficiency | 122 | 4000 | >82 | 50.000 | € 190,00 |
| 3032.128.24.Δ | SLM 3000-927 L15 # | Philips | 2320 | 26 | High Efficiency | 89 | 2700 | >97 | 50.000 | € 195,00 |
| 3032.121.24.Δ | SLM 3000-930 L15 | Philips | 2400 | 26 | High Efficiency | 92 | 3000 | >97 | 50.000 | € 195,00 |
| 3032.135.24.Δ | SLM 4500-830 L19 | Philips | 4860 | 42 | High Efficiency | 114 | 3000 | >82 | 50.000 | € 230,00 |
| 3032.136.24.Δ | SLM 4500-840 L19 | Philips | 5160 | 42 | High Efficiency | 122 | 4000 | >82 | 50.000 | € 230,00 |
| 3032.157.24.Δ | SLM 4500-927 L19 | Philips | 3760 | 42 | High Efficiency | 89 | 2700 | >97 | 50.000 | € 235,00 |
| 3032.137.24.Δ | SLM 4500-930 L19 | Philips | 3930 | 42 | High Efficiency | 92 | 3000 | >97 | 50.000 | € 235,00 |
| 3032.109.24.Δ | SLM CW 3000-930 L15 | Philips | 2790 | 34 | Crisp White | 82 | 3000 | >92 | 50.000 | € 200,00 |
| 3032.110.24.Δ | SLM CW 3800-930 L19 | Philips | 2790 | 34 | Crisp White | 82 | 3000 | >92 | 50.000 | € 240,00 |
| 3032.159.24.Δ | SLM FW 2800-925 L19 | Philips | 2880 | 42 | Food Warm White | 69 | 2900 | >90 | 50.000 | € 255,00 |
| 3032.160.24.Δ | SLM FR 3000-930 L19 | Philips | 2980 | 42 | Food Premium red | 72 | 3150 | >87 | 50.000 | € 255,00 |

* SLM G4: High efficacy is Keylight standard. High value: option for more Lumen flux output (more power, more watt) option on request.
 # SLM 827 + 927, On special request
 - SLM Premium White (colour point bBBL) 2000 Lm / 4500 Lm 3000k, On special request

TECHNICAL INFORMATION

PRODUCT

FOLLOW



- PRODUCT MATERIAL** ▶ Die-cast aluminium
- ADAPTER** ▶ 3-phase track adapter
- LIGHT SOURCE** ▶ Fortimo SLM G4
- MODULE LIFETIME** ▶ Approx. 50.000 hours
- LED COOLING** ▶ Passive cooling
- DRIVER** ▶ Incl. titanium driver
- COLORS (Δ)** ▶
 - 3 = RAL 9003 white
 - 5 = RAL 9005 black
 - 6 = RAL 9006 alu
- BEAM ANGLE** ▶ 24°
- ADJUSTABLE** ▶ Horizontally and vertically rotational
- SIZE** ▶ 242 X 236MM

OPTIONS

- OPTIONAL BEAM ANGLE** ▶ 12° / 36° € 5,00
- DIMMABLE** ▶ Dimmable on request.
- MONO POINT** ▶ To fix the track light to the ceiling or wall.
 - Color 3 - 5 - 6 € 28,50
- DIFFUSER** ▶ 0180.999.99 (frosted diffuser) € 7,50
- DIFFUSER W/ HOLE** ▶ 0185.999.99 (frosted diffuser) € 7,50

INFORMATION

- WARRANTY** ▶ 5 Years

Δ = product color code. See colors

Keylight International B.V. reserves the right to modify or change technical, construction or LED specifications due to continuous improvements of our products and lightsources.



FOLLOW

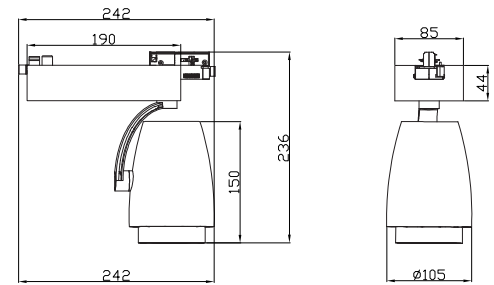

Technical drawing

| ARTICLE NO. | LAMP TYPE | BRAND | LIGHT OUTPUT | MODULE POWER | SETTING * | MODULE EFFICIENCY | CORRELATED COLOUR TEMPERATURE | COLOUR RENDERING INDEX | B50/L70 AT TC LIFE | SALES PRICE |
|---------------|---------------------|---------|--------------|--------------|------------------|-------------------|-------------------------------|------------------------|--------------------|-------------|
| Δ see colors | GEN 4 | | LM | W | | LM/W | K | RA | HRS | EURO |
| 3025.111.24.Δ | SLM 1100-827 L13 # | Philips | 1160 | 10 | High Efficiency | 114 | 2700 | >82 | 50.000 | € 170,00 |
| 3025.112.24.Δ | SLM 1100-830 L13 | Philips | 1240 | 10 | High Efficiency | 122 | 3000 | >82 | 50.000 | € 170,00 |
| 3025.113.24.Δ | SLM 1100-840 L13 | Philips | 1330 | 10 | High Efficiency | 130 | 4000 | >82 | 50.000 | € 170,00 |
| 3025.114.24.Δ | SLM 2000-830 L13 | Philips | 2020 | 17 | High Efficiency | 117 | 3000 | >82 | 50.000 | € 180,00 |
| 3025.116.24.Δ | SLM 2000-840 L13 | Philips | 2150 | 17 | High Efficiency | 124 | 4000 | >82 | 50.000 | € 180,00 |
| 3025.125.24.Δ | SLM 2000-927 L13 # | Philips | 1570 | 17 | High Efficiency | 91 | 2700 | >97 | 50.000 | € 185,00 |
| 3025.120.24.Δ | SLM 2000-930 L13 | Philips | 1650 | 17 | High Efficiency | 95 | 3000 | >97 | 50.000 | € 185,00 |
| 3025.117.24.Δ | SLM 3000-830 L15 | Philips | 2970 | 26 | High Efficiency | 114 | 3000 | >82 | 50.000 | € 190,00 |
| 3025.119.24.Δ | SLM 3000-840 L15 | Philips | 3170 | 26 | High Efficiency | 122 | 4000 | >82 | 50.000 | € 190,00 |
| 3025.128.24.Δ | SLM 3000-927 L15 # | Philips | 2320 | 26 | High Efficiency | 89 | 2700 | >97 | 50.000 | € 195,00 |
| 3025.121.24.Δ | SLM 3000-930 L15 | Philips | 2400 | 26 | High Efficiency | 92 | 3000 | >97 | 50.000 | € 195,00 |
| 3025.135.24.Δ | SLM 4500-830 L19 | Philips | 4860 | 42 | High Efficiency | 114 | 3000 | >82 | 50.000 | € 230,00 |
| 3025.136.24.Δ | SLM 4500-840 L19 | Philips | 5160 | 42 | High Efficiency | 122 | 4000 | >82 | 50.000 | € 230,00 |
| 3025.157.24.Δ | SLM 4500-927 L19 | Philips | 3760 | 42 | High Efficiency | 89 | 2700 | >97 | 50.000 | € 235,00 |
| 3025.137.24.Δ | SLM 4500-930 L19 | Philips | 3930 | 42 | High Efficiency | 92 | 3000 | >97 | 50.000 | € 235,00 |
| 3025.109.24.Δ | SLM CW 3000-930 L15 | Philips | 2790 | 34 | Crisp White | 82 | 3000 | >92 | 50.000 | € 200,00 |
| 3025.110.24.Δ | SLM CW 3800-930 L19 | Philips | 2790 | 34 | Crisp White | 82 | 3000 | >92 | 50.000 | € 240,00 |
| 3025.159.24.Δ | SLM FW 2800-925 L19 | Philips | 2880 | 42 | Food Warm White | 69 | 2900 | >90 | 50.000 | € 255,00 |
| 3032.160.24.Δ | SLM FR 3000-930 L19 | Philips | 2980 | 42 | Food Premium red | 72 | 3150 | >87 | 50.000 | € 255,00 |

* SLM G4: High efficacy is Keylight standard, High value: option for more Lumen flux output (more power, more watt) option on request.
 # SLM 827 + 927, On special request
 - SLM Premium White (colour point bBBL) 2000 Lm / 4500 Lm 3000k, On special request

TECHNICAL INFORMATION

PRODUCT

STREAM LED



- PRODUCT MATERIAL** ▶ Die-cast aluminium
- ADAPTER** ▶ 3-phase track adapter
- LIGHT SOURCE** ▶ Fortimo SLM G4
- MODULE LIFETIME** ▶ Approx. 50.000 hours
- LED COOLING** ▶ Passive cooling
- DRIVER** ▶ Incl. titanium driver
- COLORS (Δ)** ▶
 - 3 = RAL 9003 white
 - 5 = RAL 9005 black
 - 6 = RAL 9006 alu
- BEAM ANGLE** ▶ 24°
- ADJUSTABLE** ▶ Horizontally and vertically rotational
- SIZE** ▶ 203 X 263MM

OPTIONS

- OPTIONAL BEAM ANGLE** ▶ 12° / 36° € 5,00
- DIMMABLE** ▶ Dimmable on request.
- MONO POINT** ▶ To fix the track light to the ceiling or wall.
 - Color 3 - 5 - 6 € 28,50
- DIFFUSER** ▶ 0180.999.99 (frosted diffuser) € 7,50
- DIFFUSER W/ HOLE** ▶ 0185.999.99 (frosted diffuser) € 7,50

INFORMATION

- WARRANTY** ▶ 5 Years

Δ = product color code. See colors
Long-life patented LED cooling system.

Keylight International B.V. reserves the right to modify or change technical, construction or LED specifications due to continuous improvements of our products and lightsources.



STREAM LED

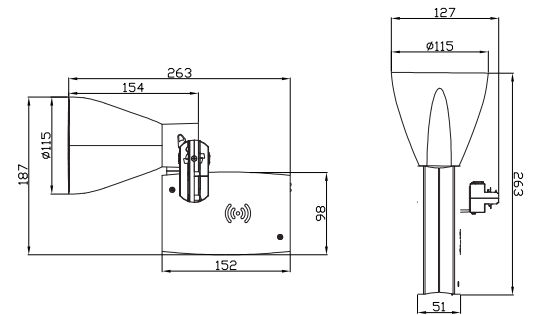

Technical drawing

| ARTICLE NO. | LAMP TYPE | BRAND | LIGHT OUTPUT | MODULE POWER | SETTING * | MODULE EFFICIENCY | CORRELATED COLOUR TEMPERATURE | COLOUR RENDERING INDEX | B50/L70 AT TC LIFE | SALES PRICE |
|---------------|---------------------|---------|--------------|--------------|-----------------|-------------------|-------------------------------|------------------------|--------------------|-------------|
| Δ see colors | GEN 4 | | LM | W | | LM/W | K | RA | HRS | EURO |
| 3026.111.24.Δ | SLM 1100-827 L13 # | Philips | 1160 | 10 | High Efficiency | 114 | 2700 | >82 | 50.000 | € 155,00 |
| 3026.112.24.Δ | SLM 1100-830 L13 | Philips | 1240 | 10 | High Efficiency | 122 | 3000 | >82 | 50.000 | € 155,00 |
| 3026.113.24.Δ | SLM 1100-840 L13 | Philips | 1330 | 10 | High Efficiency | 130 | 4000 | >82 | 50.000 | € 155,00 |
| 3026.114.24.Δ | SLM 2000-830 L13 | Philips | 2020 | 17 | High Efficiency | 117 | 3000 | >82 | 50.000 | € 165,00 |
| 3026.116.24.Δ | SLM 2000-840 L13 | Philips | 2150 | 17 | High Efficiency | 124 | 4000 | >82 | 50.000 | € 165,00 |
| 3026.125.24.Δ | SLM 2000-927 L13 # | Philips | 1570 | 17 | High Efficiency | 91 | 2700 | >97 | 50.000 | € 170,00 |
| 3026.120.24.Δ | SLM 2000-930 L13 | Philips | 1650 | 17 | High Efficiency | 95 | 3000 | >97 | 50.000 | € 170,00 |
| 3026.117.24.Δ | SLM 3000-830 L15 | Philips | 2970 | 26 | High Efficiency | 114 | 3000 | >82 | 50.000 | € 175,00 |
| 3026.119.24.Δ | SLM 3000-840 L15 | Philips | 3170 | 26 | High Efficiency | 122 | 4000 | >82 | 50.000 | € 175,00 |
| 3026.128.24.Δ | SLM 3000-927 L15 # | Philips | 2320 | 26 | High Efficiency | 89 | 2700 | >97 | 50.000 | € 180,00 |
| 3026.121.24.Δ | SLM 3000-930 L15 | Philips | 2400 | 26 | High Efficiency | 92 | 3000 | >97 | 50.000 | € 180,00 |
| 3026.109.24.Δ | SLM CW 3000-930 L15 | Philips | 2790 | 34 | Crisp White | 82 | 3000 | >92 | 50.000 | € 195,00 |

* SLM G4: High efficacy is Keylight standard, High value: option for more Lumen flux output (more power, more watt) option on request.
SLM 827 + 927, On special request
- SLM Premium White (colour point bBBL) 2000 Lm / 4500 Lm 3000k, On special request

TECHNICAL INFORMATION

PRODUCT

SOYUZ



- PRODUCT MATERIAL** ▶ Die-cast aluminium
- ADAPTER** ▶ 1-phase standard, 3-phase **On request**
- LIGHT SOURCE** ▶ Fortimo SLM G4
- MODULE LIFETIME** ▶ Approx. 50.000 hours
- LED COOLING** ▶ Passive cooling
- DRIVER** ▶ Incl. titanium driver
- COLORS (Δ)** ▶
 - 3 = RAL 9003 white
 - 5 = RAL 9005 black
 - 6 = RAL 9006 alu
- BEAM ANGLE** ▶ 27°
- ADJUSTABLE** ▶ Horizontally and vertically rotational
- SIZE** ▶ 85 X 140MM

OPTIONS

- OPTIONAL BEAM ANGLE** ▶ 21° / 45° € 5,00
- DIMMABLE** ▶ Dali dimmable € 75,00
- MONO POINT** ▶ To fix the track light to the ceiling or wall.
 - Color 3 - 5 - 6 € 28,50
- 3-PHASE** ▶ 0199.999.99Δ

INFORMATION

- WARRANTY** ▶ 5 Years

Δ = product color code. See colors

Keylight International B.V. reserves the right to modify or change technical, construction or LED specifications due to continuous improvements of our products and lightsources.



SOYUZ

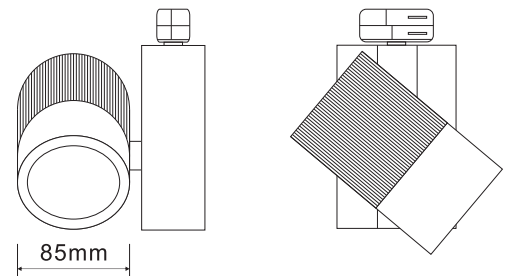

Technical drawing

| ARTICLE NO. | LAMP TYPE | BRAND | LIGHT OUTPUT | MODULE POWER | SETTING * | MODULE EFFICIENCY | CORRELATED COLOUR TEMPERATURE | COLOUR RENDERING INDEX | B50/L70 AT TC LIFE | SALES PRICE |
|---------------|---------------------|---------|--------------|--------------|-----------------|-------------------|-------------------------------|------------------------|--------------------|-------------|
| Δ see colors | GEN 4 | | LM | W | | LM/W | K | RA | HRS | EURO |
| 3030.111.27.Δ | SLM 1100-827 L13 # | Philips | 1160 | 10 | High Efficiency | 114 | 2700 | >82 | 50.000 | € 160,00 |
| 3030.112.27.Δ | SLM 1100-830 L13 | Philips | 1240 | 10 | High Efficiency | 122 | 3000 | >82 | 50.000 | € 155,00 |
| 3030.113.27.Δ | SLM 1100-840 L13 | Philips | 1330 | 10 | High Efficiency | 130 | 4000 | >82 | 50.000 | € 155,00 |
| 3030.114.27.Δ | SLM 2000-830 L13 | Philips | 2020 | 17 | High Efficiency | 117 | 3000 | >82 | 50.000 | € 165,00 |
| 3030.116.27.Δ | SLM 2000-840 L13 | Philips | 2150 | 17 | High Efficiency | 124 | 4000 | >82 | 50.000 | € 165,00 |
| 3030.125.27.Δ | SLM 2000-927 L13 # | Philips | 1570 | 17 | High Efficiency | 91 | 2700 | >97 | 50.000 | € 170,00 |
| 3030.120.27.Δ | SLM 2000-930 L13 | Philips | 1650 | 17 | High Efficiency | 95 | 3000 | >97 | 50.000 | € 170,00 |
| 3030.117.27.Δ | SLM 3000-830 L15 | Philips | 2970 | 26 | High Efficiency | 114 | 3000 | >82 | 50.000 | € 175,00 |
| 3030.119.27.Δ | SLM 3000-840 L15 | Philips | 3170 | 26 | High Efficiency | 122 | 4000 | >82 | 50.000 | € 175,00 |
| 3030.128.27.Δ | SLM 3000-927 L15 # | Philips | 2320 | 26 | High Efficiency | 89 | 2700 | >97 | 50.000 | € 180,00 |
| 3030.121.27.Δ | SLM 3000-930 L15 | Philips | 2400 | 26 | High Efficiency | 92 | 3000 | >97 | 50.000 | € 180,00 |
| 3030.109.27.Δ | SLM CW 3000-930 L15 | Philips | 2790 | 34 | Crisp White | 82 | 3000 | >92 | 50.000 | € 195,00 |

* SLM G4: High efficacy is Keylight standard, High value: option for more Lumen flux output (more power, more watt) option on request.
 # SLM 827 + 927, On special request
 - SLM Premium White (colour point bBBL) 2000 Lm / 4500 Lm 3000k, On special request

TECHNICAL INFORMATION

PRODUCT

TWIN



- PRODUCT MATERIAL** ▶ Die-cast aluminium
- ADAPTER** ▶ 3-phase.
- LIGHT SOURCE** ▶ Fortimo SLM G4
- MODULE LIFETIME** ▶ Approx. 50.000 hours
- LED COOLING** ▶ Passive cooling
- DRIVER** ▶ Incl. titanium driver
- COLORS (Δ)** ▶ ● = RAL 9005 black
 ○ + ● = RAL 9003 + black front
- BEAM ANGLE** ▶ 24°
- ADJUSTABLE** ▶ Horizontally and vertically rotational
- SIZE** ▶ 85 X 140MM

OPTIONS

- OPTIONAL BEAM ANGLE** ▶ 16° / 36° € 5,00
- DIMMABLE** ▶ Dali dimmable € 75,00
- MONO POINT** ▶ To fix the track light to the ceiling or wall.
 Color 3 - 5 - 6 € 28,50
- DIFFUSER** ▶ Frosted diffuser € 7,50
- ACCESSOIRES** ▶ Honeycomb louvre € 12,50

INFORMATION

- WARRANTY** ▶ 5 Years

Keylight International B.V. reserves the right to modify or change technical, construction or LED specifications due to continuous improvements of our products and lightsources.



TWIN



Optional honeycomb louvre

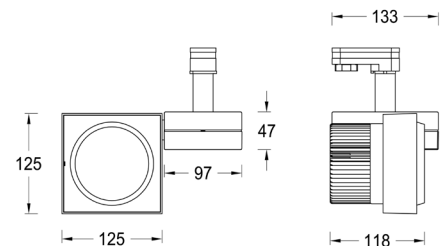

Technical drawing

| ARTICLE NO. | LAMP TYPE | BRAND | LIGHT OUTPUT | MODULE POWER | SETTING * | MODULE EFFICIENCY | CORRELATED COLOUR TEMPERATURE | COLOUR RENDERING INDEX | B50/L70 AT TC LIFE | SALES PRICE |
|----------------|---------------------|---------|--------------|--------------|-----------------|-------------------|-------------------------------|------------------------|--------------------|-------------|
| Δ see colors | GEN 4 | | LM | W | | LM/W | K | RA | HRS | EURO |
| 3033.111.24.Δ | SLM 1100-827 L13 # | Philips | 1160 | 10 | High Efficiency | 114 | 2700 | >82 | 50.000 | € 155,00 |
| 3033.112.24.Δ | SLM 1100-830 L13 | Philips | 1240 | 10 | High Efficiency | 122 | 3000 | >82 | 50.000 | € 150,00 |
| 3033.113.24.Δ | SLM 1100-840 L13 | Philips | 1330 | 10 | High Efficiency | 130 | 4000 | >82 | 50.000 | € 150,00 |
| 3033.114.24.Δ | SLM 2000-830 L13 | Philips | 2020 | 17 | High Efficiency | 117 | 3000 | >82 | 50.000 | € 160,00 |
| 3033.116.24.Δ | SLM 2000-840 L13 | Philips | 2150 | 17 | High Efficiency | 124 | 4000 | >82 | 50.000 | € 160,00 |
| 3033.125.24.Δ | SLM 2000-927 L13 # | Philips | 1570 | 17 | High Efficiency | 91 | 2700 | >97 | 50.000 | € 165,00 |
| 3033.120.24.Δ | SLM 2000-930 L13 | Philips | 1650 | 17 | High Efficiency | 95 | 3000 | >97 | 50.000 | € 165,00 |
| 3033.117.24.Δ | SLM 3000-830 L15 | Philips | 2970 | 26 | High Efficiency | 114 | 3000 | >82 | 50.000 | € 170,00 |
| 3033.119.24.Δ | SLM 3000-840 L15 | Philips | 3170 | 26 | High Efficiency | 122 | 4000 | >82 | 50.000 | € 170,00 |
| 3033.128.24.Δ | SLM 3000-927 L15 # | Philips | 2320 | 26 | High Efficiency | 89 | 2700 | >97 | 50.000 | € 175,00 |
| 3033.121.24.Δ | SLM 3000-930 L15 | Philips | 2400 | 26 | High Efficiency | 92 | 3000 | >97 | 50.000 | € 175,00 |
| 3033.109.24.-Δ | SLM CW 3000-930 L15 | Philips | 2790 | 34 | Crisp White | 82 | 3000 | >92 | 50.000 | € 190,00 |

* SLM G4: High efficacy is Keylight standard. High value: option for more Lumen flux output (more power, more watt) option on request.
 # SLM 827 + 927, On special request
 - SLM Premium White (colour point bBBL) 2000 Lm / 4500 Lm 3000k, On special request

TECHNICAL INFORMATION

PRODUCT

BUZZA



- PRODUCT MATERIAL** ▶ Die-cast aluminium
- ADAPTER** ▶ 3-phase track adapter
- LIGHT SOURCE** ▶ Fortimo DLM-I
- MODULE LIFETIME** ▶ Approx. 25.000 hours
- LED COOLING** ▶ Passive cooling
- DRIVER** ▶ Incl. integrated driver
- COLORS (Δ)** ▶ ● **3** = RAL 9003 white
- BEAM ANGLE** ▶ 60°
- ADJUSTABLE** ▶ Horizontally and vertically rotational
- SIZE** ▶ 151 X 238MM

OPTIONS

- MONO POINT** ▶ To fix the track light to the ceiling or wall.
Color 3 - 5 - 6 € 28,50

INFORMATION

- WARRANTY** ▶ 3 Years

Not dimmable

Keylight International B.V. reserves the right to modify or change technical, construction or LED specifications due to continuous improvements of our products and lightsources.



BUZZA

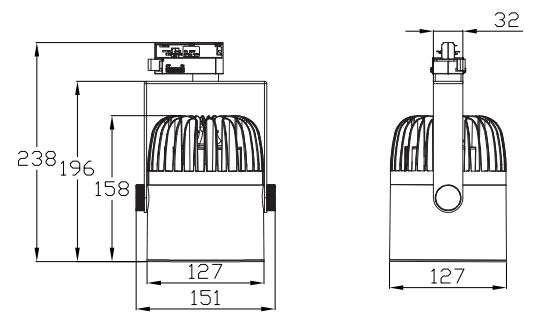

Technical drawing

| ARTICLE NO. | LAMP TYPE | BRAND | LIGHT OUTPUT | MODULE POWER | MODULE EFFICIENCY | CORRELATED COLOUR TEMPERATURE | COLOUR RENDERING INDEX | TC LIFE | ADAPTER | SALES PRICE |
|---------------|-----------|---------|--------------|--------------|-------------------|-------------------------------|------------------------|---------|---------|-------------|
| | | | LM | W | LM/W | K | RA | HRS | | EURO |
| 3022.122.60.3 | DLM-Int | Philips | 1100 | 15 | 73 | 3000 | >80 | 25.000 | 3-phase | € 150,00 |
| 3022.123.60.3 | DLM-Int | Philips | 1100 | 14 | 79 | 4000 | >80 | 25.000 | 3-phase | € 150,00 |
| 3022.124.60.3 | DLM-Int | Philips | 2000 | 28 | 71 | 3000 | >80 | 25.000 | 3-phase | € 165,00 |
| 3022.125.60.3 | DLM-Int | Philips | 2000 | 27 | 74 | 4000 | >80 | 25.000 | 3-phase | € 165,00 |

TECHNICAL INFORMATION

PRODUCT

DRUM



- PRODUCT MATERIAL** ▶ Die-cast aluminium
- ADAPTER** ▶ 3-phase track adapter
- LIGHT SOURCE** ▶ Core AC 230v
- MODULE LIFETIME** ▶ Approx. 50.000 hours
- LED COOLING** ▶ Passive cooling
- DRIVER** ▶ Not needed. Direct 230V
- COLORS (Δ)** ▶
 - 3 = RAL 9003 white
 - 5 = RAL 9005 black
 - 6 = RAL 9006 alu
- BEAM ANGLE** ▶ 24°
- ADJUSTABLE** ▶ Horizontally and vertically rotational
- SIZE** ▶ 105 X 210MM

OPTIONS

- MONO POINT** ▶ To fix the track light to the ceiling or wall.
 - Color 3 - 5 - 6 € 28,50
- OPTIONAL BEAM ANGLE** ▶ 36° € 5,00

INFORMATION

- WARRANTY** ▶ 3 Years

Δ = product color code. See colors

Not dimmable
Long-life patented LED cooling system.
Flicker Free

Keylight International B.V. reserves the right to modify or change technical, construction or LED specifications due to continuous improvements of our products and lightsources.



DRUM

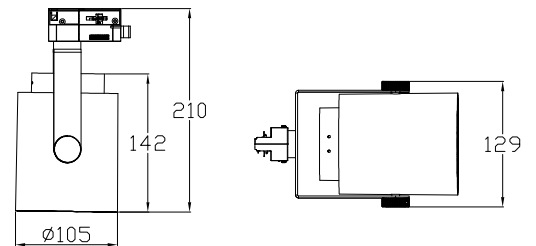

Technical drawing

| ARTICLE NO. | LAMP TYPE | BRAND | LIGHT OUTPUT | MODULE POWER | MODULE EFFICIENCY | CORRELATED COLOUR TEMPERATURE | COLOUR RENDERING INDEX | TC LIFE | SALES PRICE |
|---------------|-------------|-------|--------------|--------------|-------------------|-------------------------------|------------------------|---------|-------------|
| | | | LM | W | LM/W | K | RA | HRS | EURO |
| 3035.750.20.Δ | Core AC Pro | Osram | 2000 | 20 | 100 | 3000 | >80 | 50.000 | € 150,00 |
| 3035.751.20.Δ | Core AC Pro | Osram | 2000 | 20 | 103 | 4000 | >80 | 50.000 | € 150,00 |
| 3035.752.20.Δ | Core AC Pro | Osram | 3000 | 33 | 90 | 3000 | >80 | 50.000 | € 160,00 |
| 3035.753.20.Δ | Core AC Pro | Osram | 3000 | 33 | 93 | 4000 | >80 | 50.000 | € 160,00 |

TECHNICAL INFORMATION

PRODUCT

FORCE



- PRODUCT MATERIAL** ▶ Die-cast aluminium
- ADAPTER** ▶ 3-phase track adapter
- LIGHT SOURCE** ▶ Core AC 230v
- MODULE LIFETIME** ▶ Approx. 50.000 hours
- LED COOLING** ▶ Passive cooling
- DRIVER** ▶ Not needed. Direct 230V
- COLORS (Δ)** ▶
 - 3 = RAL 9003 white
 - 5 = RAL 9005 black
- BEAM ANGLE** ▶ 24°
- ADJUSTABLE** ▶ Horizontally and vertically rotational
- SIZE** ▶ 124 X 216MM

OPTIONS

- MONO POINT** ▶ To fix the track light to the ceiling or wall.
Color 3 - 5 - 6 € 28,50
- OPTIONAL BEAM ANGLE** ▶ 36° € 5,00

INFORMATION

- WARRANTY** ▶ 3 Years

Δ = product color code. See colors

Not dimmable
Long-life patented LED cooling system.

Flicker Free

Keylight International B.V. reserves the right to modify or change technical, construction or LED specifications due to continuous improvements of our products and lightsources.



FORCE

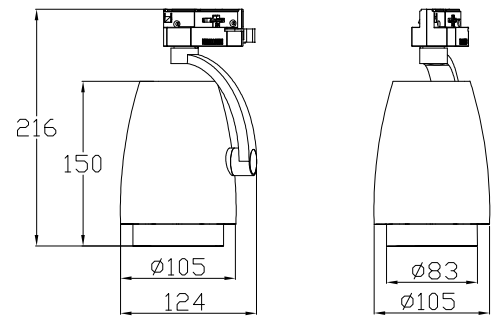

Technical drawing

| ARTICLE NO. | LAMP TYPE | BRAND | LIGHT OUTPUT | MODULE POWER | MODULE EFFICIENCY | CORRELATED COLOUR TEMPERATURE | COLOUR RENDERING INDEX | TC LIFE | SALES PRICE |
|---------------|-------------|-------|--------------|--------------|-------------------|-------------------------------|------------------------|---------|-------------|
| | | | LM | W | LM/W | K | RA | HRS | EURO |
| 3036.750.20.Δ | Core AC Pro | Osram | 2000 | 20 | 100 | 3000 | >80 | 50.000 | € 145,00 |
| 3036.751.20.Δ | Core AC Pro | Osram | 2000 | 20 | 103 | 4000 | >80 | 50.000 | € 145,00 |
| 3036.752.20.Δ | Core AC Pro | Osram | 3000 | 33 | 90 | 3000 | >80 | 50.000 | € 155,00 |
| 3036.753.20.Δ | Core AC Pro | Osram | 3000 | 33 | 93 | 4000 | >80 | 50.000 | € 155,00 |

TECHNICAL INFORMATION

PRODUCT

DAXX



- PRODUCT MATERIAL** ▶ Die-cast aluminium
- ADAPTER** ▶ 3-phase track adapter
- LIGHT SOURCE** ▶ Core AC 230v
- MODULE LIFETIME** ▶ Approx. 50.000 hours
- LED COOLING** ▶ Passive cooling
- DRIVER** ▶ Not needed. Direct 230V
- COLORS (Δ)** ▶ ● + ● = RAL 9003 + black
- BEAM ANGLE** ▶ 36°
- ADJUSTABLE** ▶ Horizontally and vertically rotational
- SIZE** ▶ 115 X 178MM

OPTIONS

- MONO POINT** ▶ To fix the track light to the ceiling or wall.
Color 3 - 5 - 6 € 28,50
- OPTIONAL BEAM ANGLE** ▶ 24° / 50° € 5,00

INFORMATION

- WARRANTY** ▶ 3 Years

Not dimmable
Long-life patented LED cooling system.
Flicker Free

Keylight International B.V. reserves the right to modify or change technical, construction or LED specifications due to continuous improvements of our products and lightsources.



DAXX

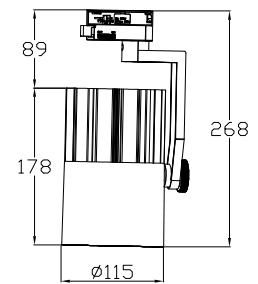

Technical drawing

| ARTICLE NO. | LAMP TYPE | BRAND | LIGHT OUTPUT | MODULE POWER | MODULE EFFICIENCY | CORRELATED COLOUR TEMPERATURE | COLOUR RENDERING INDEX | TC LIFE | SALES PRICE |
|---------------|-------------|-------|--------------|--------------|-------------------|-------------------------------|------------------------|---------|-------------|
| | | | LM | W | LM/W | K | RA | HRS | EURO |
| 3034.750.20.5 | Core AC Pro | Osram | 2000 | 20 | 100 | 3000 | >80 | 50.000 | € 175,00 |
| 3034.751.20.5 | Core AC Pro | Osram | 2000 | 20 | 103 | 4000 | >80 | 50.000 | € 175,00 |
| 3034.752.20.5 | Core AC Pro | Osram | 3000 | 33 | 90 | 3000 | >80 | 50.000 | € 185,00 |
| 3034.753.20.5 | Core AC Pro | Osram | 3000 | 33 | 93 | 4000 | >80 | 50.000 | € 185,00 |

TECHNICAL INFORMATION

PRODUCT

COLT 14



- PRODUCT MATERIAL** ▶ Die-cast aluminium
- ADAPTER** ▶ 1-phase track adapter
- LIGHT SOURCE** ▶ MasterLED
- DRIVER** ▶ Philips driver included
- COLORS (Δ)** ▶
 - 3 = RAL 9003 white
 - 5 = RAL 9005 black
 - 6 = RAL 9006 alu
- BEAM ANGLE** ▶ 25° / 40°
- ADJUSTABLE** ▶ Horizontally and vertically rotational
- DIMMABLE** ▶ Standard
- SIZE** ▶ 80 X 70MM

OPTIONS

- MONO POINT** ▶ To fix the track light to the ceiling or wall.
Color 3 - 5 - 6 € 10,00

INFORMATION

- WARRANTY** ▶ 2 Years

! Only luminaire body, lightsource excluded.

* Specification may vary per type of lightsource

Keylight International B.V. reserves the right to modify or change technical, construction or LED specifications due to continuous improvements of our products and lightsources.



COLT 14

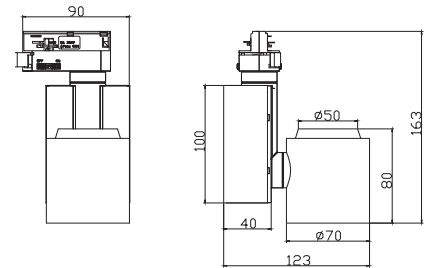

Technical drawing

| ARTICLE NO. | LAMP TYPE | BRAND | LIGHT OUTPUT | MODULE POWER | MODULE EFFICIENCY | CORRELATED COLOUR TEMPERATURE | COLOUR RENDERING INDEX | TC LIFE | ADAPTER | SALES PRICE |
|-----------------------|-----------|--------------|--------------|--------------|-------------------|-------------------------------|------------------------|---------|---------|-------------|
| Δ see colors | | | LM | W | LM/W | K | RA | HRS | | EURO |
| ! 3119.305.24Δ | GU5.3 | Retrofit LED | * | * | * | * | * | * | 1-phase | € 55,00 |

TECHNICAL INFORMATION

PRODUCT

ARTI



- PRODUCT MATERIAL** ▶ Die-cast aluminium
- ADAPTER** ▶ 1-phase track adapter
- LIGHT SOURCE** ▶ COB LED
- MODULE LIFETIME** ▶ Approx. 25.000 hours
- LED COOLING** ▶ Passive cooling
- DRIVER** ▶ Included
- COLORS (Δ)** ▶
 - 3 = RAL 9003 white
 - 5 = RAL 9005 black
 - 6 = RAL 9006 alu
- BEAM ANGLE** ▶ 24°
- ADJUSTABLE** ▶ Horizontally and vertically rotational
- SIZE** ▶ 120 X 110MM

OPTIONS

- MONO POINT** ▶ To fix the track light to the ceiling or wall.
Color 3 - 5 - 6 € 10,00

INFORMATION

- WARRANTY** ▶ 2 Years

Not dimmable

Keylight International B.V. reserves the right to modify or change technical, construction or LED specifications due to continuous improvements of our products and lightsources.



ARTI

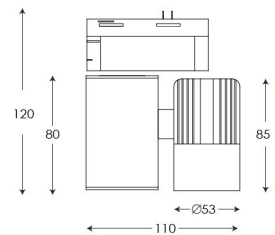

Technical drawing

| ARTICLE NO. | LAMP TYPE | BRAND | LIGHT OUTPUT | MODULE POWER | MODULE EFFICIENCY | CORRELATED COLOUR TEMPERATURE | COLOUR RENDERING INDEX | TC LIFE | ADAPTER | SALES PRICE |
|----------------|-----------|-------|--------------|--------------|-------------------|-------------------------------|------------------------|---------|---------|-------------|
| | | | LM | W | LM/W | K | RA | HRS | | EURO |
| 3037.999.99.24 | CXA COB | CREE | 700 | 10 | 70 | 3000 | >80 | 25.000 | 1-phase | € 65,00 |

KEYLIGHT 1-PHASE



| ARTICLE NO. | DESCRIPTION | LENGTH IN MM | COLOR | PHASE | SALES PRICE |
|---------------|-------------|--------------|-------|-------|-------------|
| 9110.995.99.3 | Track rail | 1000 | White | 1 | € 19,00 |
| 9110.995.99.5 | Track rail | 1000 | Black | 1 | € 19,00 |
| 9110.995.99.6 | Track rail | 1000 | Alu | 1 | € 19,00 |
| 9120.995.99.3 | Track rail | 2000 | White | 1 | € 38,00 |
| 9120.995.99.5 | Track rail | 2000 | Black | 1 | € 38,00 |
| 9120.995.99.6 | Track rail | 2000 | Alu | 1 | € 38,00 |
| 9130.995.99.3 | Track rail | 3000 | White | 1 | € 55,00 |
| 9130.995.99.5 | Track rail | 3000 | Black | 1 | € 55,00 |
| 9130.995.99.6 | Track rail | 3000 | Alu | 1 | € 55,00 |



| ARTICLE NO. | DESCRIPTION | POLARITY SIDE | COLOR | PHASE | SALES PRICE |
|---------------|-------------|---------------|-------|-------|-------------|
| 9152.995.99.3 | End Feed | | White | 1 | € 4,00 |
| 9152.995.99.5 | End Feed | | Black | 1 | € 4,00 |
| 9152.995.99.6 | End Feed | | Alu | 1 | € 4,00 |
| 9153.995.99.3 | End Feed | | White | 1 | € 4,00 |
| 9153.995.99.5 | End Feed | | Black | 1 | € 4,00 |
| 9153.995.99.6 | End Feed | | Alu | 1 | € 4,00 |



| ARTICLE NO. | DESCRIPTION | COLOR | PHASE | SALES PRICE |
|---------------|-------------|-------|-------|-------------|
| 9155.995.99.3 | Middle feed | White | 1 | € 7,50 |
| 9155.995.99.5 | Middle feed | Black | 1 | € 7,50 |
| 9155.995.99.6 | Middle feed | Alu | 1 | € 7,50 |

Keylight International B.V. reserves the right to modify or change technical, construction or LED specifications due to continuous improvements of our products and lightsources.



| ARTICLE NO. | DESCRIPTION | COLOR | PHASE | SALES PRICE |
|---------------|--------------------|-------|-------|-------------|
| 9151.995.99.3 | Straight connector | White | 1 | € 3,00 |
| 9151.995.99.5 | Straight connector | Black | 1 | € 3,00 |
| 9151.995.99.6 | Straight connector | Alu | 1 | € 3,00 |



| ARTICLE NO. | DESCRIPTION | POLARITY SIDE | COLOR | PHASE | SALES PRICE |
|---------------|-------------|---------------|-------|-------|-------------|
| 9154.995.99.3 | L Feed | | White | 1 | € 7,00 |
| 9154.995.99.5 | L Feed | | Black | 1 | € 7,00 |
| 9154.995.99.6 | L Feed | | Alu | 1 | € 7,00 |



| ARTICLE NO. | DESCRIPTION | POLARITY SIDE | COLOR | PHASE | SALES PRICE |
|---------------|-------------|---------------|-------|-------|-------------|
| 9163.995.99.3 | L Feed | | White | 1 | € 7,00 |
| 9163.995.99.5 | L Feed | | Black | 1 | € 7,00 |
| 9163.995.99.6 | L Feed | | Alu | 1 | € 7,00 |



| ARTICLE NO. | DESCRIPTION | POLARITY SIDE | COLOR | PHASE | SALES PRICE |
|---------------|-------------|---------------|-------|-------|-------------|
| 9156.995.99.3 | T Feed | | White | 1 | € 11,50 |
| 9156.995.99.5 | T Feed | | Black | 1 | € 11,50 |
| 9156.995.99.6 | T Feed | | Alu | 1 | € 11,50 |

KEYLIGHT 1-PHASE



| ARTICLE NO. | DESCRIPTION | POLARITY SIDE | COLOR | PHASE | SALES PRICE |
|---------------|-------------|---------------|-------|-------|-------------|
| 9164.995.99.3 | T Feed | | White | 1 | € 11,50 |
| 9164.995.99.5 | T Feed | | Black | 1 | € 11,50 |
| 9164.995.99.6 | T Feed | | Alu | 1 | € 11,50 |



| ARTICLE NO. | DESCRIPTION | COLOR | PHASE | SALES PRICE |
|---------------|-------------|-------|-------|-------------|
| 9157.995.99.3 | X Feed | White | 1 | € 15,00 |
| 9157.995.99.5 | X Feed | Black | 1 | € 15,00 |
| 9157.995.99.6 | X Feed | Alu | 1 | € 15,00 |



| ARTICLE NO. | DESCRIPTION | COLOR | PHASE | SALES PRICE |
|---------------|-------------|-------|-------|-------------|
| 9159.995.99.3 | End Cap | White | 1 | € 0,75 |
| 9159.995.99.5 | End Cap | Black | 1 | € 0,75 |
| 9159.995.99.6 | End Cap | Alu | 1 | € 0,75 |



| ARTICLE NO. | DESCRIPTION | COLOR | PHASE | SALES PRICE |
|---------------|-------------|-------|-------|-------------|
| 9158.995.99.3 | Adapter M10 | White | 1 | € 6,50 |
| 9158.995.99.5 | Adapter M10 | Black | 1 | € 6,50 |
| 9158.995.99.6 | Adapter M10 | Alu | 1 | € 6,50 |



3.V. resp.
to cor

| ARTICLE NO. | DESCRIPTION | LENGTH IN MM | COLOR | PHASE | SALES PRICE |
|---------------|----------------------------|--------------|-------|-------|-------------|
| 9160.995.99.3 | Suspension set Steel cable | 50 - 3000 | White | 1 | € 9,00 |
| 9160.995.99.5 | Suspension set Steel cable | 50 - 3000 | Black | 1 | € 9,00 |
| 9160.995.99.6 | Suspension set Steel cable | 50 - 3000 | Alu | 1 | € 9,00 |



| ARTICLE NO. | DESCRIPTION | LENGTH IN MM | COLOR | PHASE | SALES PRICE |
|---------------|-----------------------|--------------|-------|-------|-------------|
| 9161.995.99.3 | Suspension set Pendle | 200 - 1100 | White | 1 | € 23,00 |
| 9161.995.99.5 | Suspension set Pendle | 200 - 1100 | Black | 1 | € 23,00 |
| 9161.995.99.6 | Suspension set Pendle | 200 - 1100 | Alu | 1 | € 23,00 |



| ARTICLE NO. | DESCRIPTION | COLOR | PHASE | SALES PRICE |
|---------------|-------------|-------|-------|-------------|
| 9162.995.99.3 | Monopoint | White | 1 | € 10,00 |
| 9162.995.99.5 | Monopoint | Black | 1 | € 10,00 |
| 9162.995.99.6 | Monopoint | Alu | 1 | € 10,00 |

GLOBAL TRAC PRO 3-PHASE



| ARTICLE NO. | DESCRIPTION | LENGTH IN MM | COLOR | PHASE | SALES PRICE |
|---------------|-------------|--------------|-------|-------|-------------|
| 9332.995.99.3 | Track rail | 2000 | White | 3 | € 51,00 |
| 9332.995.99.5 | Track rail | 2000 | Black | 3 | € 51,00 |
| 9332.995.99.6 | Track rail | 2000 | Alu | 3 | € 51,00 |
| 9333.995.99.3 | Track rail | 3000 | White | 3 | € 80,00 |
| 9333.995.99.5 | Track rail | 3000 | Black | 3 | € 80,00 |
| 9333.995.99.6 | Track rail | 3000 | Alu | 3 | € 80,00 |
| 9334.995.99.3 | Track rail | 4000 | White | 3 | € 95,00 |
| 9334.995.99.5 | Track rail | 4000 | Black | 3 | € 95,00 |
| 9334.995.99.6 | Track rail | 4000 | Alu | 3 | € 95,00 |



| ARTICLE NO. | DESCRIPTION | COLOR | PHASE | SALES PRICE |
|---------------|-------------|-------|-------|-------------|
| 9351.995.99.3 | End Feed | White | 3 | € 15,00 |
| 9351.995.99.5 | End Feed | Black | 3 | € 15,00 |
| 9351.995.99.6 | End Feed | Alu | 3 | € 15,00 |
| 9352.995.99.3 | End Feed | White | 3 | € 15,00 |
| 9352.995.99.5 | End Feed | Black | 3 | € 15,00 |
| 9352.995.99.6 | End Feed | Alu | 3 | € 15,00 |



| ARTICLE NO. | DESCRIPTION | COLOR | PHASE | SALES PRICE |
|---------------|-------------|-------|-------|-------------|
| 9353.995.99.3 | Middle feed | White | 3 | € 39,00 |
| 9353.995.99.5 | Middle feed | Black | 3 | € 39,00 |
| 9353.995.99.6 | Middle feed | Alu | 3 | € 39,00 |

Keylight International B.V. reserves the right to modify or change technical, construction or LED specifications due to continuous improvements of our products and lightsources.



| ARTICLE NO. | DESCRIPTION | COLOR | PHASE | SALES PRICE |
|---------------|--------------------|-------|-------|-------------|
| 9354.995.99.3 | Straight connector | White | 3 | € 10,00 |
| 9354.995.99.5 | Straight connector | Black | 3 | € 10,00 |
| 9354.995.99.6 | Straight connector | Alu | 3 | € 10,00 |



| ARTICLE NO. | DESCRIPTION | COLOR | PHASE | SALES PRICE |
|---------------|---------------------------|-------|-------|-------------|
| 9367.995.99.3 | Flexible corner connector | White | 3 | € 42,00 |
| 9367.995.99.5 | Flexible corner connector | Black | 3 | € 42,00 |
| 9367.995.99.6 | Flexible corner connector | Alu | 3 | € 42,00 |



| ARTICLE NO. | DESCRIPTION | COLOR | PHASE | SALES PRICE |
|---------------|-----------------------------|-------|-------|-------------|
| 9363.995.99.3 | Adjustable corner connector | White | 3 | € 42,00 |
| 9363.995.99.5 | Adjustable corner connector | Black | 3 | € 42,00 |
| v.995.99.6 | Adjustable corner connector | Alu | 3 | € 42,00 |



| ARTICLE NO. | DESCRIPTION | COLOR | PHASE | SALES PRICE |
|---------------|-------------|-------|-------|-------------|
| 9362.995.99.3 | X Feed | White | 3 | € 51,00 |
| 9362.995.99.5 | X Feed | Black | 3 | € 51,00 |
| 9362.995.99.6 | X Feed | Alu | 3 | € 51,00 |

GLOBAL TRAC PRO 3-PHASE



| ARTICLE NO. | DESCRIPTION | POLARITY SIDE | COLOR | PHASE | SALES PRICE |
|---------------|-------------|---------------|-------|-------|-------------|
| 9356.995.99.3 | L Feed | | White | 3 | € 26,00 |
| 9356.995.99.5 | L Feed | | Black | 3 | € 26,00 |
| 9356.995.99.6 | L Feed | | Alu | 3 | € 26,00 |

| | | | | | |
|---------------|--------|--|-------|---|---------|
| 9355.995.99.3 | L Feed | | White | 3 | € 26,00 |
| 9355.995.99.5 | L Feed | | Black | 3 | € 26,00 |
| 9355.995.99.6 | L Feed | | Alu | 3 | € 26,00 |



| ARTICLE NO. | DESCRIPTION | POLARITY SIDE | COLOR | PHASE | SALES PRICE |
|---------------|-------------|---------------|-------|-------|-------------|
| 9357.995.99.3 | T Feed | | White | 3 | € 39,00 |
| 9357.995.99.5 | T Feed | | Black | 3 | € 39,00 |
| 9357.995.99.6 | T Feed | | Alu | 3 | € 39,00 |



| | | | | | |
|---------------|--------|--|-------|---|---------|
| 9359.995.99.3 | T Feed | | White | 3 | € 39,00 |
| 9359.995.99.5 | T Feed | | Black | 3 | € 39,00 |
| 9359.995.99.6 | T Feed | | Alu | 3 | € 26,00 |



| | | | | | |
|---------------|--------|--|-------|---|---------|
| 9361.995.99.3 | T Feed | | White | 3 | € 39,00 |
| 9361.995.99.5 | T Feed | | Black | 3 | € 39,00 |
| 9361.995.99.6 | T Feed | | Alu | 3 | € 39,00 |

Keylight International B.V. reserves the right to modify or change technical, construction or LED specifications due to continuous improvements of our products and lightsources.



| | | | | | |
|---------------|--------|--|-------|---|---------|
| 9358.995.99.3 | T Feed | | White | 3 | € 39,00 |
| 9358.995.99.5 | T Feed | | Black | 3 | € 39,00 |
| 9358.995.99.6 | T Feed | | Alu | 3 | € 39,00 |



| ARTICLE NO. | DESCRIPTION | COLOR | PHASE | SALES PRICE |
|---------------|-------------|-------|-------|-------------|
| 9364.995.99.3 | End Cap | White | 3 | € 1,95 |
| 9364.995.99.5 | End Cap | Black | 3 | € 1,95 |
| 9364.995.99.6 | End Cap | Alu | 3 | € 1,95 |



| ARTICLE NO. | DESCRIPTION | COLOR | PHASE | SALES PRICE |
|---------------|-------------|-------|-------|-------------|
| 9366.995.99.3 | Fix Point | White | 3 | € 28,50 |
| 9366.995.99.5 | Fix Point | Black | 3 | € 28,50 |
| 9366.995.99.6 | Fix Point | Alu | 3 | € 28,50 |



Recessed tracks

All 3 phase tracks are also available as recessed tracks. For more information, contact us.



Pulse track

All 3 phase tracks are also available with pulse dali 1-10v. For more information, contact us



Profile Systems



PROFILE 6
PAGE 1



PROFILE 6 R
PAGE 1



PROFILE 8
PAGE 1



PROFILE 8 R
PAGE 1



PROFILE 6 W (UP/DN)
PAGE 1



PROFILE 18 D + 18 ID
PAGE 1

Profile Systems

| | |
|-----------|--------|
| UTAH 18 | PAGE 1 |
| YORK | PAGE 1 |
| DL 180 | PAGE 1 |
| KANSAS 16 | PAGE 1 |
| DEEP 22 | PAGE 1 |
| DEEP 22 | PAGE 1 |

TECHNICAL INFORMATION

PRODUCT

PROFILE 6



- PRODUCT MATERIAL** ▶ Aluminium profile
- LIGHT SOURCE** ▶ Philips Ledline
- MODULE LIFETIME** ▶ Approx. 50.000 hours
- LED COOLING** ▶ Passive cooling
- DRIVER LEDLINE** ▶ Incl. standard xitanium driver.
- COLORS (Δ)** ▶
 - 3 = RAL 9003 white
 - 5 = RAL 9005 black
 - 6 = RAL 9006 alu
- REFLECTOR PLATE** ▶ Opal diffuser / acrylic
- ADJUSTABLE** ▶ No
- SIZE** ▶ **581/862/1143/1424 X 60.4 X 78MM**

OPTIONS

- COLORS** ▶ Available in all RAL colours on request
Additional price + 10%
- DIMMABLE** ▶ Dimmable DALI on request
- SUSPENSION SET** ▶ standard length 1.5m € 17,00

INFORMATION

- WARRANTY** ▶ 5 Years

Δ see colors

This luminaire can be mounted directly to the ceiling or pendent with steel wires and can be connected to form long LED lighting lines.

We can produce this luminaire in different lengths and shapes on request.

Keylight International B.V. reserves the right to modify or change technical, construction or LED specifications due to continuous improvements of our products and lightsources.

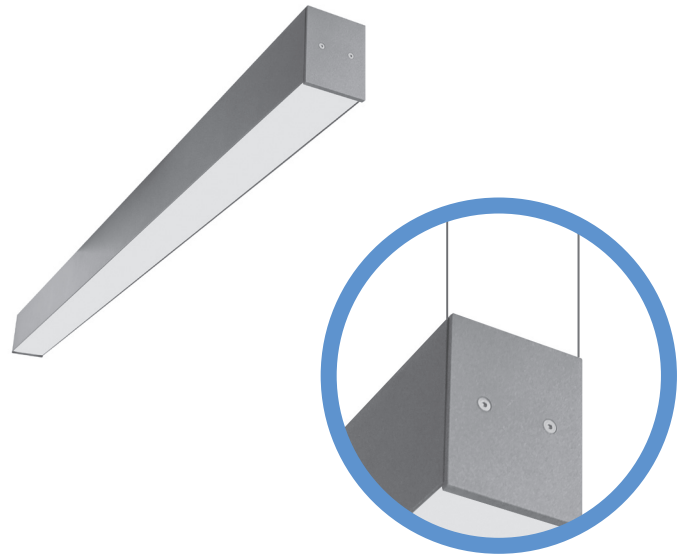

PROFILE 6

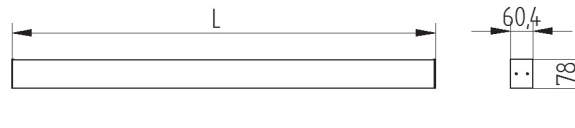

Technical drawing

| ARTICLE NO. | LAMP TYPE | BRAND | LIGHT OUTPUT | MODULE POWER | MODULE EFFICIENCY | CORRELATED COLOUR TEMPERATURE | COLOUR RENDERING INDEX | TC LIFE | LENGTH | SALES PRICE |
|--------------|-----------|---------|--------------|--------------|-------------------|-------------------------------|------------------------|---------|--------|-------------|
| Δ see colors | | | LM | W | LM/W | K | RA | HRS | MM | EURO |
| 9113.197.91Δ | Ledline | Philips | 2200 | 16 | 137 | 3000 | >80 | 50.000 | 581 | € 245,00 |
| 9113.198.91Δ | Ledline | Philips | 2200 | 16 | 137 | 4000 | >80 | 50.000 | 581 | € 245,00 |
| 9113.295.91Δ | Ledline | Philips | 3300 | 24 | 137 | 3000 | >80 | 50.000 | 862 | € 290,00 |
| 9113.296.91Δ | Ledline | Philips | 3300 | 24 | 137 | 4000 | >80 | 50.000 | 862 | € 290,00 |
| 9114.197.91Δ | Ledline | Philips | 4400 | 32 | 137 | 3000 | >80 | 50.000 | 1143 | € 335,00 |
| 9114.198.91Δ | Ledline | Philips | 4400 | 32 | 137 | 4000 | >80 | 50.000 | 1143 | € 335,00 |
| 9114.291.91Δ | Ledline | Philips | 5500 | 40 | 137 | 3000 | >80 | 50.000 | 1424 | € 375,00 |
| 9114.292.91Δ | Ledline | Philips | 5500 | 40 | 137 | 4000 | >80 | 50.000 | 1424 | € 375,00 |
| 9226.197.91Δ | Ledline | Philips | 8000 | 62 | 137 | 3000 | >80 | 50.000 | 1143 | € 375,00 |
| 9226.198.91Δ | Ledline | Philips | 8000 | 62 | 137 | 4000 | >80 | 50.000 | 1143 | € 375,00 |
| 9226.293.91Δ | Ledline | Philips | 10.000 | 77 | 137 | 3000 | >80 | 50.000 | 1424 | € 475,00 |
| 9226.294.91Δ | Ledline | Philips | 10.000 | 77 | 137 | 4000 | >80 | 50.000 | 1424 | € 475,00 |

TECHNICAL INFORMATION

PRODUCT

PROFILE 6 R



- PRODUCT MATERIAL** ▶ Aluminium profile
- LIGHT SOURCE** ▶ Philips Ledline
- MODULE LIFETIME** ▶ Approx. 50.000 hours
- LED COOLING** ▶ Passive cooling
- DRIVER LEDLINE** ▶ Incl. standard xitanium driver.
- COLORS (Δ)** ▶
 - 3 = RAL 9003 white
 - 5 = RAL 9005 black
 - 6 = RAL 9006 alu
- REFLECTOR PLATE** ▶ Opal diffuser / acrylic
- ADJUSTABLE** ▶ No
- SIZE** ▶ 601/882/1163/1444 X 60.4 X 78MM

OPTIONS

- COLORS** ▶ Available in all RAL colours on request
Additional price + 10%
- DIMMABLE** ▶ Dimmable DALI on request

INFORMATION

- WARRANTY** ▶ 5 Years

Δ see colors

This luminaire can be mounted directly in to the ceiling and can be connected to form long LED lighting lines.

We can produce this luminaire in different lengths and shapes on request.

Keylight International B.V. reserves the right to modify or change technical, construction or LED specifications due to continuous improvements of our products and lightsources.



PROFILE 6 R

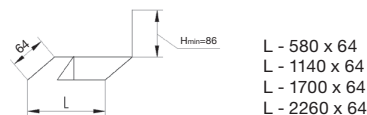

- L - 580 x 64
- L - 1140 x 64
- L - 1700 x 64
- L - 2260 x 64

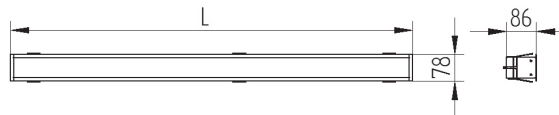

Technical drawing

| ARTICLE NO. | LAMP TYPE | BRAND | LIGHT OUTPUT | MODULE POWER | MODULE EFFICIENCY | CORRELATED COLOUR TEMPERATURE | COLOUR RENDERING INDEX | TC LIFE | LENGTH | SALES PRICE |
|--------------|-----------|---------|--------------|--------------|-------------------|-------------------------------|------------------------|---------|--------|-------------|
| Δ see colors | | | LM | W | LM/W | K | RA | HRS | MM | EURO |
| 9027.197.91Δ | Ledline | Philips | 2200 | 16 | 137 | 3000 | >80 | 50.000 | 601 | € 245,00 |
| 9027.198.91Δ | Ledline | Philips | 2200 | 16 | 137 | 4000 | >80 | 50.000 | 601 | € 245,00 |
| 9027.295.91Δ | Ledline | Philips | 3300 | 24 | 137 | 3000 | >80 | 50.000 | 882 | € 290,00 |
| 9027.296.91Δ | Ledline | Philips | 3300 | 24 | 137 | 4000 | >80 | 50.000 | 882 | € 290,00 |
| 9027.197.91Δ | Ledline | Philips | 4400 | 32 | 137 | 3000 | >80 | 50.000 | 1163 | € 335,00 |
| 9027.198.91Δ | Ledline | Philips | 4400 | 32 | 137 | 4000 | >80 | 50.000 | 1163 | € 335,00 |
| 9027.291.91Δ | Ledline | Philips | 5500 | 40 | 137 | 3000 | >80 | 50.000 | 1444 | € 375,00 |
| 9027.292.91Δ | Ledline | Philips | 5500 | 40 | 137 | 4000 | >80 | 50.000 | 1444 | € 375,00 |
| 9027.197.91Δ | Ledline | Philips | 8000 | 62 | 137 | 3000 | >80 | 50.000 | 1163 | € 375,00 |
| 9027.198.91Δ | Ledline | Philips | 8000 | 62 | 137 | 4000 | >80 | 50.000 | 1163 | € 375,00 |
| 9027.293.91Δ | Ledline | Philips | 10.000 | 77 | 137 | 3000 | >80 | 50.000 | 1444 | € 475,00 |
| 9027.294.91Δ | Ledline | Philips | 10.000 | 77 | 137 | 4000 | >80 | 50.000 | 1444 | € 475,00 |

TECHNICAL INFORMATION

PRODUCT

PROFILE 8



- PRODUCT MATERIAL** ▶ Aluminium profile
- LIGHT SOURCE** ▶ Philips Ledline
- MODULE LIFETIME** ▶ Approx. 50.000 hours
- LED COOLING** ▶ Passive cooling
- DRIVER LEDLINE** ▶ Incl. standard xitanium driver.
- COLORS (Δ)** ▶
 - 3 = RAL 9003 white
 - 5 = RAL 9005 black
 - 6 = RAL 9006 alu
- REFLECTOR PLATE** ▶ Opal diffuser / acrylic
- ADJUSTABLE** ▶ No
- SIZE** ▶ 581/862/1143/1424 X 80 X 76MM

OPTIONS

- COLORS** ▶ Available in all RAL colours on request
Additional price + 10%
- DIMMABLE** ▶ Dimmable DALI on request
- SUSPENSION SET** ▶ standard length 1.5m € 17,00

INFORMATION

- WARRANTY** ▶ 5 Years

Δ see colors

This luminaire can be mounted directly to the ceiling or pendent with steel wires and can be connected to form long LED lighting lines.

We can produce this luminaire in different lengths and shapes on request.

Keylight International B.V. reserves the right to modify or change technical, construction or LED specifications due to continuous improvements of our products and lightsources.

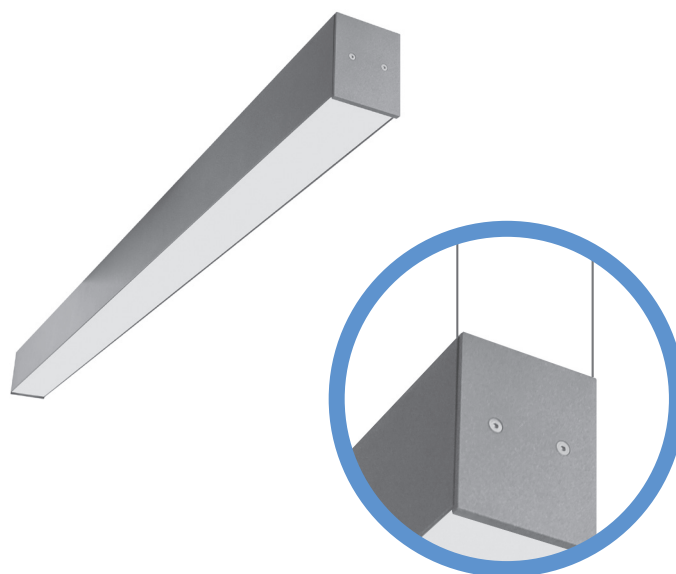

PROFILE 8

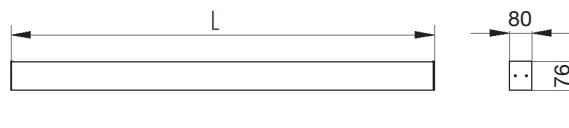

Technical drawing

| ARTICLE NO. | LAMP TYPE | BRAND | LIGHT OUTPUT | MODULE POWER | MODULE EFFICIENCY | CORRELATED COLOUR TEMPERATURE | COLOUR RENDERING INDEX | TC LIFE | LENGTH | SALES PRICE |
|--------------|-----------|---------|--------------|--------------|-------------------|-------------------------------|------------------------|---------|--------|-------------|
| Δ see colors | | | LM | W | LM/W | K | RA | HRS | MM | EURO |
| 9015.197.91Δ | Ledline | Philips | 2200 | 16 | 137 | 3000 | >80 | 50.000 | 581 | € 270,00 |
| 9015.198.91Δ | Ledline | Philips | 2200 | 16 | 137 | 4000 | >80 | 50.000 | 581 | € 270,00 |
| 9015.295.91Δ | Ledline | Philips | 3300 | 24 | 137 | 3000 | >80 | 50.000 | 862 | € 310,00 |
| 9015.296.91Δ | Ledline | Philips | 3300 | 24 | 137 | 4000 | >80 | 50.000 | 862 | € 310,00 |
| 9015.197.91Δ | Ledline | Philips | 4400 | 32 | 137 | 3000 | >80 | 50.000 | 1143 | € 350,00 |
| 9015.198.91Δ | Ledline | Philips | 4400 | 32 | 137 | 4000 | >80 | 50.000 | 1143 | € 350,00 |
| 9015.291.91Δ | Ledline | Philips | 5500 | 40 | 137 | 3000 | >80 | 50.000 | 1424 | € 395,00 |
| 9015.292.91Δ | Ledline | Philips | 5500 | 40 | 137 | 4000 | >80 | 50.000 | 1424 | € 395,00 |
| 9015.197.91Δ | Ledline | Philips | 8000 | 62 | 137 | 3000 | >80 | 50.000 | 1143 | € 395,00 |
| 9015.198.91Δ | Ledline | Philips | 8000 | 62 | 137 | 4000 | >80 | 50.000 | 1143 | € 395,00 |
| 9015.293.91Δ | Ledline | Philips | 10.000 | 77 | 137 | 3000 | >80 | 50.000 | 1424 | € 490,00 |
| 9015.294.91Δ | Ledline | Philips | 10.000 | 77 | 137 | 4000 | >80 | 50.000 | 1424 | € 490,00 |

TECHNICAL INFORMATION

PRODUCT

PROFILE 8 R



- PRODUCT MATERIAL** ▶ Aluminium profile
- LIGHT SOURCE** ▶ Philips Ledline
- MODULE LIFETIME** ▶ Approx. 50.000 hours
- LED COOLING** ▶ Passive cooling
- DRIVER LEDLINE** ▶ Incl. standard xitanium driver.
- COLORS (Δ)** ▶
 - 3 = RAL 9003 white
 - 5 = RAL 9005 black
 - 6 = RAL 9006 alu
- REFLECTOR PLATE** ▶ Opal diffuser / acrylic
- ADJUSTABLE** ▶ No
- SIZE** ▶ 601/882/1163/1444 X 60.4 X 78MM

OPTIONS

- COLORS** ▶ Available in all RAL colours on request
Additional price + 10%
- DIMMABLE** ▶ Dimmable DALI on request

INFORMATION

- WARRANTY** ▶ 5 Years

Δ see colors

This luminaire can be mounted directly in to the ceiling and can be connected to form long LED lighting lines.

We can produce this luminaire in different lengths and shapes on request.

Keylight International B.V. reserves the right to modify or change technical, construction or LED specifications due to continuous improvements of our products and lightsources.



PROFILE 8 R

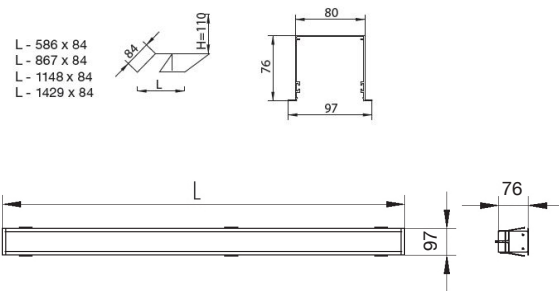

Technical drawing

| ARTICLE NO. | LAMP TYPE | BRAND | LIGHT OUTPUT | MODULE POWER | MODULE EFFICIENCY | CORRELATED COLOUR TEMPERATURE | COLOUR RENDERING INDEX | TC LIFE | LENGTH | SALES PRICE |
|--------------|-----------|---------|--------------|--------------|-------------------|-------------------------------|------------------------|---------|--------|-------------|
| Δ see colors | | | LM | W | LM/W | K | RA | HRS | MM | EURO |
| 9080.197.91Δ | Ledline | Philips | 2200 | 16 | 137 | 3000 | >80 | 50.000 | 601 | € 270,00 |
| 9080.198.91Δ | Ledline | Philips | 2200 | 16 | 137 | 4000 | >80 | 50.000 | 601 | € 270,00 |
| 9080.295.91Δ | Ledline | Philips | 3300 | 24 | 137 | 3000 | >80 | 50.000 | 882 | € 310,00 |
| 9080.296.91Δ | Ledline | Philips | 3300 | 24 | 137 | 4000 | >80 | 50.000 | 882 | € 310,00 |
| 9014.197.91Δ | Ledline | Philips | 4400 | 32 | 137 | 3000 | >80 | 50.000 | 1163 | € 350,00 |
| 9014.198.91Δ | Ledline | Philips | 4400 | 32 | 137 | 4000 | >80 | 50.000 | 1163 | € 350,00 |
| 9014.291.91Δ | Ledline | Philips | 5500 | 40 | 137 | 3000 | >80 | 50.000 | 1444 | € 395,00 |
| 9014.292.91Δ | Ledline | Philips | 5500 | 40 | 137 | 4000 | >80 | 50.000 | 1444 | € 395,00 |
| 9026.197.91Δ | Ledline | Philips | 8000 | 62 | 137 | 3000 | >80 | 50.000 | 1163 | € 395,00 |
| 9026.198.91Δ | Ledline | Philips | 8000 | 62 | 137 | 4000 | >80 | 50.000 | 1163 | € 395,00 |
| 9026.293.91Δ | Ledline | Philips | 10.000 | 77 | 137 | 3000 | >80 | 50.000 | 1444 | € 490,00 |
| 9026.294.91Δ | Ledline | Philips | 10.000 | 77 | 137 | 4000 | >80 | 50.000 | 1444 | € 490,00 |

TECHNICAL INFORMATION

PRODUCT

PROFILE 6 W (UP/DN) LED IP20 CE P

- PRODUCT MATERIAL** ▶ Aluminium profile
- LIGHT SOURCE** ▶ Philips Ledline
- MODULE LIFETIME** ▶ Approx. 50.000 hours
- LED COOLING** ▶ Passive cooling
- DRIVER LEDLINE** ▶ Incl. standard xitanium driver.
- COLORS (Δ)** ▶
 - 3 = RAL 9003 white
 - 5 = RAL 9005 black
 - 6 = RAL 9006 alu
- REFLECTOR PLATE** ▶ Opal diffuser / acrylic
- ADJUSTABLE** ▶ No
- SIZE** ▶ 671/1231 X 78 X 110MM

OPTIONS

- COLORS** ▶ Available in all RAL colours on request
Additional price + 10%
- DIMMABLE** ▶ Dimmable DALI on request

INFORMATION

- WARRANTY** ▶ 5 Years

Δ see colors

Wall mounted direct/indirect LED luminaire.

Keylight International B.V. reserves the right to modify or change technical, construction or LED specifications due to continuous improvements of our products and lightsources.



PROFILE 6 W

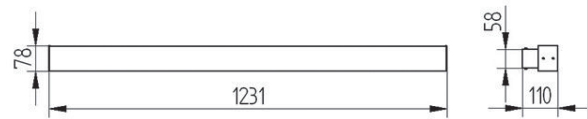

Technical drawing

| ARTICLE NO. | LAMP TYPE | BRAND | LIGHT OUTPUT | MODULE POWER | MODULE EFFICIENCY | CORRELATED COLOUR TEMPERATURE | COLOUR RENDERING INDEX | TC LIFE | LENGTH | SALES PRICE |
|--------------|-----------|---------|--------------|--------------|-------------------|-------------------------------|------------------------|---------|--------|-------------|
| Δ see colors | | | LM | W | LM/W | K | RA | HRS | MM | EURO |
| 9016.197.91Δ | Ledline | Philips | 2X 2200 | 36 | 122 | 3000 | >80 | 50.000 | 671 | € 370,00 |
| 9016.198.91Δ | Ledline | Philips | 2X 2200 | 36 | 122 | 4000 | >80 | 50.000 | 671 | € 370,00 |
| 9017.197.91Δ | Ledline | Philips | 2X 4400 | 65 | 135 | 3000 | >80 | 50.000 | 1231 | € 580,00 |
| 9017.198.91Δ | Ledline | Philips | 2X 4400 | 65 | 135 | 4000 | >80 | 50.000 | 1231 | € 580,00 |

TECHNICAL INFORMATION

PRODUCT

PROFILE 18 D + 18 ID



- PRODUCT MATERIAL** ▶ Aluminium profile
- LIGHT SOURCE** ▶ Philips Ledline
- MODULE LIFETIME** ▶ Approx. 50.000 hours
- LED COOLING** ▶ Passive cooling
- DRIVER LEDLINE** ▶ Incl. standard xitanium driver.
- COLORS (Δ)** ▶
 - 3 = RAL 9003 white
 - 5 = RAL 9005 black
 - 6 = RAL 9006 alu
- REFLECTOR PLATE** ▶ Opal diffuser / acrylic
- ADJUSTABLE** ▶ No
- SIZE** ▶ 1250 X 175 X 48MM

OPTIONS

- COLORS** ▶ Available in all RAL colours on request
Additional price + 10%
- DIMMABLE** ▶ Dimmable DALI on request
- SUSPENSION SET** ▶ standard length 1.5m € 17,00

INFORMATION

- WARRANTY** ▶ 5 Years

Δ see colors

PENDENT DIRECT LED LUMINAIRE

This luminaire can be mounted directly to the ceiling or pendent with steel wires and can be connected to form long LED lighting lines. We can produce this luminaire in different lengths and shapes on request. Standard length of suspension set: 1.5m.

Keylight International B.V. reserves the right to modify or change technical, construction or LED specifications due to continuous improvements of our products and lightsources.

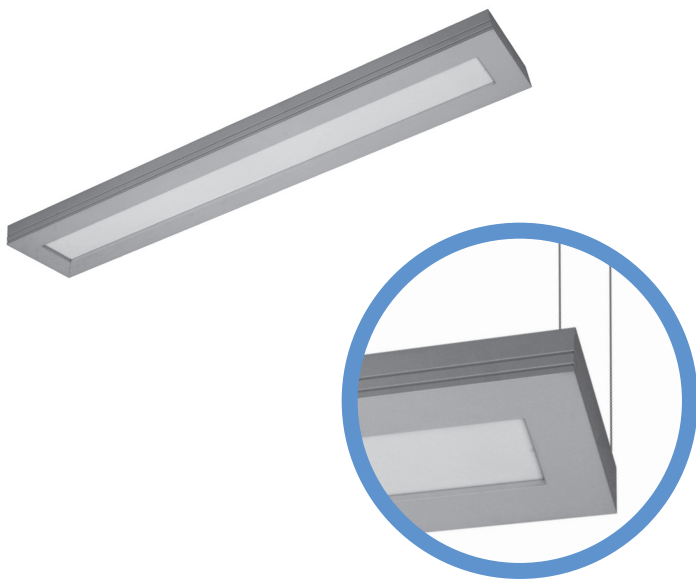

PROFILE 18 D

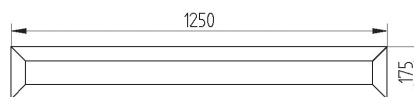

Technical drawing

| ARTICLE NO. | LAMP TYPE | BRAND | LIGHT OUTPUT | MODULE POWER | MODULE EFFICIENCY | CORRELATED COLOUR TEMPERATURE | COLOUR RENDERING INDEX | TC LIFE | SALES PRICE |
|---------------------|-----------|---------|--------------|--------------|-------------------|-------------------------------|------------------------|---------|-------------|
| PROFILE 18 D | | | | | | | | | |
| Δ see colors | | | LM | W | LM/W | K | RA | HRS | EURO |
| 9250.197.90Δ | Ledline | Philips | 4400 | 32 | 137 | 3000 | >80 | 50.000 | € 440,00 |
| 9250.198.90Δ | Ledline | Philips | 4400 | 32 | 137 | 4000 | >80 | 50.000 | € 440,00 |
| 9251.197.90Δ | Ledline | Philips | 8000 | 62 | 137 | 3000 | >80 | 50.000 | € 475,00 |
| 9250.198.90Δ | Ledline | Philips | 8000 | 62 | 137 | 4000 | >80 | 50.000 | € 475,00 |

| ARTICLE NO. | LAMP TYPE | BRAND | LIGHT OUTPUT | MODULE POWER | MODULE EFFICIENCY | CORRELATED COLOUR TEMPERATURE | COLOUR RENDERING INDEX | TC LIFE | SALES PRICE |
|----------------------|-----------|---------|--------------|--------------|-------------------|-------------------------------|------------------------|---------|-------------|
| PROFILE 18 ID | | | | | | | | | |
| Δ see colors | | | LM | W | LM/W | K | RA | HRS | EURO |
| 9253.197.90Δ | Ledline | Philips | 4400 | 32 | 137 | 3000 | >80 | 50.000 | € 440,00 |
| 9253.198.90Δ | Ledline | Philips | 4400 | 32 | 137 | 4000 | >80 | 50.000 | € 440,00 |
| 9254.197.90Δ | Ledline | Philips | 8000 | 62 | 137 | 3000 | >80 | 50.000 | € 475,00 |
| 9254.198.90Δ | Ledline | Philips | 8000 | 62 | 137 | 4000 | >80 | 50.000 | € 475,00 |



Pendent Luminaires





DRAGON P
PAGE 1



OVAL
PAGE 1



HORN S
PAGE 1



HORN M
PAGE 1



HORN L
PAGE 1



INDU LED
PAGE 1



WORK BAY
PAGE 1



CLASSIC BAY
PAGE 1



HIGH BAY
PAGE 1



ORBIT 30 P
PAGE 1



ROUNDY 12 + 15
PAGE 1



QUADRANT 70
PAGE 1



QUADRANT 90
PAGE 1



BOOST 30
PAGE 1



BOOST 40
PAGE 1



BOOST 50
PAGE 1



ORBIT 45 P
PAGE 1



ORBIT 65 P
PAGE 1



ORBIT 90 P
PAGE 1

Pendent Luminaires

| | |
|------------|--------|
| UTAH 18 | PAGE 1 |
| YORK | PAGE 1 |
| DL 180 | PAGE 1 |
| KANSAS 16 | PAGE 1 |
| DEEP 22 | PAGE 1 |
| VISION 15 | PAGE 1 |
| VISION 20 | PAGE 1 |
| ROLED | PAGE 1 |
| CAP R1 | PAGE 1 |
| CAP R2 | PAGE 1 |
| LINKON 13 | PAGE 1 |
| LINKON 14L | PAGE 1 |
| UTAH 22 | PAGE 1 |
| UTAH 18 | PAGE 1 |
| YORK | PAGE 1 |
| DL 180 | PAGE 1 |
| KANSAS 16 | PAGE 1 |
| DEEP 22 | PAGE 1 |
| VISION 15 | PAGE 1 |

DRAGON P



- PRODUCT MATERIAL** ▶ Aluminium
- LIGHT SOURCE** ▶ Cree
- MODULE LIFETIME** ▶ Approx. 30.000 hours
- LED COOLING** ▶ Passive cooling
- COLORS** ▶ ● 9 = Alu Brushed
- SIZE** ▶ 70 X 180MM
- BEAM ANGLE SPOT** ▶ 60°

INFORMATION

- WARRANTY** ▶ 5 Years

Keylight International B.V. reserves the right to modify or change technical, construction or LED specifications due to continuous improvements of our products and lightsources.



DRAGON P

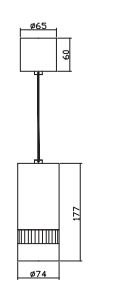

Technical drawing

| ARTICLE NO. | LAMP TYPE | BRAND | LIGHT OUTPUT | MODULE POWER | MODULE EFFICIENCY | CORRELATED COLOUR TEMPERATURE | COLOUR RENDERING INDEX | TC LIFE | SALES PRICE |
|---------------|-----------|-------|--------------|--------------|-------------------|-------------------------------|------------------------|---------|-------------|
| | | | LM | W | LM/W | K | RA | HRS | EURO |
| 7007.990.60.9 | X-PE | Cree | | 6 | | 2700 | >80 | 30.000 | € 165,00 |

OVAL



- PRODUCT MATERIAL** ▶ Steel & aluminium
- LIGHT SOURCE** ▶ Philips Fortimo Disc
- MODULE LIFETIME** ▶ Approx. 40.000 hours
- LED COOLING** ▶ Passive cooling
- COLORS (Δ)** ▶
 - 3 = RAL 9003 white
 - 5 = RAL 9005 black
 - 6 = RAL 9006 alu
- SIZE** ▶ 140 X 122MM
- BEAM ANGLE SPOT** ▶ 80°

OPTIONS

- COLORS** ▶ Available in all RAL colours on request.
Additional price + 10%
- DIMMABLE** ▶ Standard dimmable leading edge

INFORMATION

- WARRANTY** ▶ 5 Years

Δ = product color code. See colors

Keylight International B.V. reserves the right to modify or change technical, construction or LED specifications due to continuous improvements of our products and lightsources.



OVAL

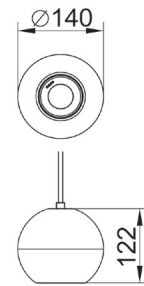

Technical drawing

| ARTICLE NO. | LAMP TYPE | BRAND | LIGHT OUTPUT | MODULE POWER | MODULE EFFICIENCY | CORRELATED COLOUR TEMPERATURE | COLOUR RENDERING INDEX | TC LIFE | POWER FACTOR | SALES PRICE |
|--------------|-----------|---------|--------------|--------------|-------------------|-------------------------------|------------------------|---------|--------------|-------------|
| Δ see colors | | | LM | W | LM/W | K | RA | HRS | PF | EURO |
| 7014.141.85Δ | Disk G3 | Philips | 800 | 12 | 68 | 2700 | >80 | 50.000 | >,09 | € 175,00 |
| 7014.142.85Δ | Disk G3 | Philips | 800 | 12 | 68 | 3000 | >80 | 50.000 | >,09 | € 175,00 |
| 7014.143.85Δ | Disk G3 | Philips | 850 | 11 | 72 | 4000 | >80 | 50.000 | >,09 | € 175,00 |

HORN S



- PRODUCT MATERIAL** ▶ Steel
- LIGHT SOURCE** ▶ Philips MasterLED
- MODULE LIFETIME** ▶ Approx. 40.000 hours
- LED COOLING** ▶ Passive cooling
- COLORS (Δ)** ▶
 - 3 = RAL 9003 white
 - 5 = RAL 9005 black
 - 6 = RAL 9006 alu
- SIZE** ▶ 80 X 230MM
- BEAM ANGLE SPOT** ▶ 25° / 40°

OPTIONS

- COLORS** ▶ Available in all RAL colours on request.
Additional price + 10%
Also available: color combinations
- DIMMABLE** ▶ Yes

INFORMATION

- WARRANTY** ▶ 5 Years

Δ = product color code. See colors

Without lightsource

Keylight International B.V. reserves the right to modify or change technical, construction or LED specifications due to continuous improvements of our products and lightsources.



HORN S

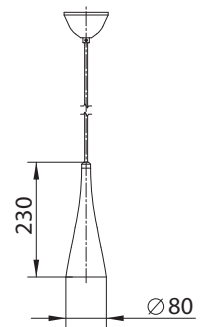

Technical drawing

| ARTICLE NO. | LAMP TYPE | BRAND | LIGHT OUTPUT | MODULE POWER | MODULE EFFICIENCY | CORRELATED COLOUR TEMPERATURE | COLOUR RENDERING INDEX | TC LIFE | BEAM ANGLE | SALES PRICE |
|---------------|-----------|---------|--------------|--------------|-------------------|-------------------------------|------------------------|---------|------------|-------------|
| Δ see colors | | | LM | W | LM/W | K | RA | HRS | ° | EURO |
| 7520.601.99 Δ | MasterLED | Philips | 410 | 8 | 51 | 2700 | >80 | 40.000 | 25 | € 160,00 |
| 7520.602.99 Δ | MasterLED | Philips | 410 | 8 | 51 | 2700 | >80 | 40.000 | 40 | € 160,00 |
| 7520.603.99 Δ | MasterLED | Philips | 450 | 8 | 56 | 3000 | >80 | 40.000 | 25 | € 160,00 |
| 7520.604.99 Δ | MasterLED | Philips | 450 | 8 | 56 | 3000 | >80 | 40.000 | 40 | € 160,00 |
| 7520.605.99 Δ | MasterLED | Philips | 460 | 8 | 58 | 4000 | >80 | 40.000 | 25 | € 160,00 |
| 7520.606.99 Δ | MasterLED | Philips | 460 | 8 | 58 | 4000 | >80 | 40.000 | 40 | € 160,00 |

TECHNICAL INFORMATION

PRODUCT

HORN M



- PRODUCT MATERIAL** ▶ Steel
- LIGHT SOURCE** ▶ Philips Integrated
- MODULE LIFETIME** ▶ Approx. 50.000 hours
- LED COOLING** ▶ Passive cooling
- COLORS (Δ)** ▶
 - 3 = RAL 9003 white
 - 5 = RAL 9005 black
 - 6 = RAL 9006 alu
- SIZE** ▶ 80 X 230MM
- BEAM ANGLE SPOT** ▶ 25° / 40°

OPTIONS

- COLORS** ▶ Available in all RAL colours on request.
Additional price + 10%
Also available: color combinations
- DIMMABLE** ▶ N/A

INFORMATION

- WARRANTY** ▶ 5 Years

Δ = product color code. See colors

Keylight International B.V. reserves the right to modify or change technical, construction or LED specifications due to continuous improvements of our products and lightsources.



HORN M

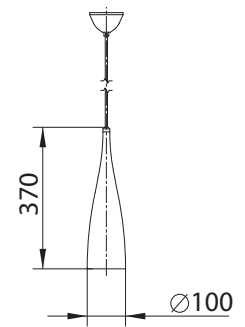

Technical drawing

| ARTICLE NO. | LAMP TYPE | BRAND | LIGHT OUTPUT | MODULE POWER | MODULE EFFICIENCY | CORRELATED COLOUR TEMPERATURE | COLOUR RENDERING INDEX | TC LIFE | BEAM ANGLE | SALES PRICE |
|---------------|-----------------|---------|--------------|--------------|-------------------|-------------------------------|------------------------|---------|------------|-------------|
| Δ see colors | | | LM | W | LM/W | K | RA | HRS | ° | EURO |
| 7521.912.15 Δ | Integrated spot | Philips | 600 | 13 | 46 | 2700 | >80 | 50.000 | 15 | € 175,00 |
| 7521.912.24 Δ | Integrated spot | Philips | 600 | 13 | 46 | 2700 | >80 | 50.000 | 24 | € 175,00 |
| 7521.912.36 Δ | Integrated spot | Philips | 600 | 13 | 46 | 2700 | >80 | 50.000 | 36 | € 175,00 |
| 7521.913.15 Δ | Integrated spot | Philips | 640 | 13 | 51 | 3000 | >80 | 50.000 | 15 | € 175,00 |
| 7521.913.24 Δ | Integrated spot | Philips | 640 | 13 | 51 | 3000 | >80 | 50.000 | 24 | € 175,00 |
| 7521.913.36 Δ | Integrated spot | Philips | 640 | 13 | 51 | 3000 | >80 | 50.000 | 36 | € 175,00 |
| 7521.914.15 Δ | Integrated spot | Philips | 640 | 13 | 51 | 4000 | >80 | 50.000 | 15 | € 175,00 |
| 7521.914.24 Δ | Integrated spot | Philips | 640 | 13 | 51 | 4000 | >80 | 50.000 | 24 | € 175,00 |
| 7521.914.36 Δ | Integrated spot | Philips | 640 | 13 | 51 | 4000 | >80 | 50.000 | 36 | € 175,00 |

TECHNICAL INFORMATION

PRODUCT

HORN L



- PRODUCT MATERIAL** ▶ Steel
- LIGHT SOURCE** ▶ Philips Fortimo Disc
- MODULE LIFETIME** ▶ Approx. 40.000 hours
- LED COOLING** ▶ Passive cooling
- COLORS (Δ)** ▶
 - 3 = RAL 9003 white
 - 5 = RAL 9005 black
 - 6 = RAL 9006 alu
- SIZE** ▶ 300 X 395MM
- BEAM ANGLE SPOT** ▶ 80°

OPTIONS

- COLORS** ▶ Available in all RAL colours on request.
Additional price + 10%
Also available: color combinations
- DIMMABLE** ▶ Standard dimmable leading edge

INFORMATION

- WARRANTY** ▶ 5 Years

Δ = product color code. See colors

Keylight International B.V. reserves the right to modify or change technical, construction or LED specifications due to continuous improvements of our products and lightsources.



HORN L

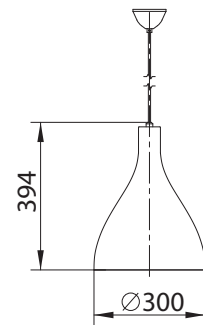

Technical drawing

| ARTICLE NO. | LAMP TYPE | BRAND | LIGHT OUTPUT | MODULE POWER | MODULE EFFICIENCY | CORRELATED COLOUR TEMPERATURE | COLOUR RENDERING INDEX | TC LIFE | POWER FACTOR | SALES PRICE |
|--------------|-----------|---------|--------------|--------------|-------------------|-------------------------------|------------------------|---------|--------------|-------------|
| Δ see colors | | | LM | W | LM/W | K | RA | HRS | PF | EURO |
| 7522.141.85Δ | Disk G3 | Philips | 800 | 12 | 68 | 2700 | >80 | 50.000 | >,09 | € 210,00 |
| 7522.142.85Δ | Disk G3 | Philips | 800 | 12 | 68 | 3000 | >80 | 50.000 | >,09 | € 210,00 |
| 7522.143.85Δ | Disk G3 | Philips | 850 | 11 | 72 | 4000 | >80 | 50.000 | >,09 | € 210,00 |

Keylight International B.V. reserves the right to modify or change technical, construction or LED specifications due to continuous improvements of our products and lightsources.

TECHNICAL INFORMATION

PRODUCT

BOOST 30



- PRODUCT MATERIAL** ▶ Steel + alu
- LIGHT SOURCE** ▶ Twistable G3
- MODULE LIFETIME** ▶ Approx. 50.000 hours
- LED COOLING** ▶ Passive cooling
- DRIVER** ▶ Incl. Integrated driver.
- COLORS (Δ)** ▶
 - 3 = RAL 9003 white
 - 5 = RAL 9005 black
 - 6 = RAL 9006 alu
- BEAM ANGLE** ▶ N/A
- ADJUSTABLE** ▶ No
- SIZE** ▶ 315 X 285MM

OPTIONS

- COLORS** ▶ Available in all RAL colours on request
Additional price + 10%
- DIMMABLE** ▶ Standard dimmable leading edge.
- GLASS & IP RING** ▶ Optional IP44 cover on request

INFORMATION

- WARRANTY** ▶ 5 Years

Δ = product color code. See colors

1.5m suspension set standard.

Acrylic 315mm reflector

Keylight International B.V. reserves the right to modify or change technical, construction or LED specifications due to continuous improvements of our products and lightsources.



BOOST 30

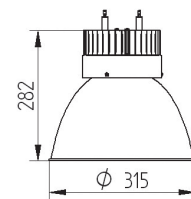

Technical drawing

| ARTICLE NO. | LAMP TYPE | BRAND | LIGHT OUTPUT | MODULE POWER | MODULE EFFICIENCY | CORRELATED COLOUR TEMPERATURE | COLOUR RENDERING INDEX | TC LIFE | SUSP. SET | SALES PRICE |
|--------------|--------------|---------|--------------|--------------|-------------------|-------------------------------|------------------------|---------|-----------|-------------|
| Δ see colors | | | LM | W | LM/W | K | RA | HRS | M | EURO |
| 7315.148.92Δ | Twistable G3 | Philips | 2000 | 30 | 70 | 3000 | >80 | 50.000 | 1.5 | € 315,00 |
| 7315.149.92Δ | Twistable G3 | Philips | 2000 | 28 | 77 | 4000 | >80 | 50.000 | 1.5 | € 315,00 |

TECHNICAL INFORMATION

PRODUCT

BOOST 40



- PRODUCT MATERIAL** ▶ Steel and aluminium
- LIGHT SOURCE** ▶ DLM-I / DLM G5
- MODULE LIFETIME** ▶ DLM Approx. 50.000 hours
- LED COOLING** ▶ Passive cooling
- DRIVER DLM** ▶ Incl. standard xitanium driver.
- COLORS Δ** ▶
 - 3 = RAL 9003 black
 - 5 = RAL 9005 white
 - 6 = RAL 9006 alu
- BEAM ANGLE** ▶ Acrylic 415mm reflector
- ADJUSTABLE** ▶ No
- SIZE** ▶ 415 X 448MM

OPTIONS

- COLORS** ▶ Available in all RAL colours on request
Additional price + 10%
- DIMMABLE** ▶ Dimmable DALI € 45,00
- GLASS & IP RING** ▶ Optional IP44 cover on request

INFORMATION

- WARRANTY** ▶ 5 Years

Δ = product color code. See colors

1.5m suspension set standard.

Acrylic 415mm reflector

Keylight International B.V. reserves the right to modify or change technical, construction or LED specifications due to continuous improvements of our products and lightsources.



BOOST 40

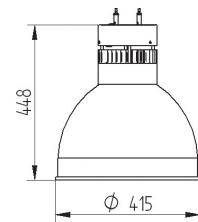

Technical drawing

| ARTICLE NO. | LAMP TYPE | BRAND | LIGHT OUTPUT | MODULE POWER | MODULE EFFICIENCY | CORRELATED COLOUR TEMPERATURE | COLOUR RENDERING INDEX | TC LIFE | SUSP. SET | SALES PRICE |
|--------------|-----------|---------|--------------|--------------|-------------------|-------------------------------|------------------------|---------|-----------|-------------|
| Δ see colors | | | LM | W | LM/W | K | RA | HRS | M | EURO |
| 7415.101.92Δ | DLM G5 | Philips | 1100 | 11 | 100 | 3000 | >80 | 50.000 | 1.5 | € 395,00 |
| 7415.102.92Δ | DLM G5 | Philips | 1100 | 10 | 110 | 4000 | >80 | 50.000 | 1.5 | € 395,00 |
| 7415.103.92Δ | DLM G5 | Philips | 2000 | 21 | 95 | 3000 | >80 | 50.000 | 1.5 | € 410,00 |
| 7415.104.92Δ | DLM G5 | Philips | 2000 | 19 | 105 | 4000 | >80 | 50.000 | 1.5 | € 410,00 |
| 7415.105.92Δ | DLM G5 | Philips | 3000 | 32 | 94 | 3000 | >80 | 50.000 | 1.5 | € 420,00 |
| 7415.106.92Δ | DLM G5 | Philips | 3000 | 29 | 103 | 4000 | >80 | 50.000 | 1.5 | € 420,00 |

TECHNICAL INFORMATION

PRODUCT

BOOST 50



- PRODUCT MATERIAL** ▶ Steel and aluminium
- LIGHT SOURCE** ▶ DLM-I / DLM G5
- MODULE LIFETIME** ▶ DLM Approx. 50.000 hours
- LED COOLING** ▶ Passive cooling
- DRIVER DLM** ▶ Incl. standard titanium driver.
- COLORS Δ** ▶
 - 3 = RAL 9003 black
 - 5 = RAL 9005 white
 - 6 = RAL 9006 alu
- BEAM ANGLE** ▶ Acrylic 515mm reflector
- ADJUSTABLE** ▶ No
- SIZE** ▶ 515 X 493MM

OPTIONS

- COLORS** ▶ Available in all RAL colours on request
Additional price + 10%
- DIMMABLE** ▶ Dimmable DALI € 45,00
- GLASS & IP RING** ▶ Optional IP44 cover on request

INFORMATION

- WARRANTY** ▶ 5 Years

Δ = product color code. See colors

1.5m suspension set standard.

Acrylic 515mm reflector

Keylight International B.V. reserves the right to modify or change technical, construction or LED specifications due to continuous improvements of our products and lightsources.



BOOST 50

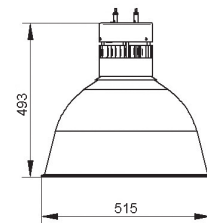

Technical drawing

| ARTICLE NO. | LAMP TYPE | BRAND | LIGHT OUTPUT | MODULE POWER | MODULE EFFICIENCY | CORRELATED COLOUR TEMPERATURE | COLOUR RENDERING INDEX | TC LIFE | SUSP. SET | SALES PRICE |
|--------------|-----------|---------|--------------|--------------|-------------------|-------------------------------|------------------------|---------|-----------|-------------|
| Δ see colors | | | LM | W | LM/W | K | RA | HRS | M | EURO |
| 7515.101.92Δ | DLM G5 | Philips | 1100 | 11 | 100 | 3000 | >80 | 50.000 | 1.5 | € 430,00 |
| 7515.102.92Δ | DLM G5 | Philips | 1100 | 10 | 110 | 4000 | >80 | 50.000 | 1.5 | € 430,00 |
| 7515.103.92Δ | DLM G5 | Philips | 2000 | 21 | 95 | 3000 | >80 | 50.000 | 1.5 | € 445,00 |
| 7515.104.92Δ | DLM G5 | Philips | 2000 | 19 | 105 | 4000 | >80 | 50.000 | 1.5 | € 445,00 |
| 7515.105.92Δ | DLM G5 | Philips | 3000 | 32 | 94 | 3000 | >80 | 50.000 | 1.5 | € 455,00 |
| 7515.106.92Δ | DLM G5 | Philips | 3000 | 29 | 103 | 4000 | >80 | 50.000 | 1.5 | € 455,00 |

TECHNICAL INFORMATION

PRODUCT

INDU LED



- PRODUCT MATERIAL** ▶ Steel and aluminium
- LIGHT SOURCE** ▶ DLM-I / DLM G5 / DLM Food
- MODULE LIFETIME** ▶ DLM Approx. 50.000 hours
- LED COOLING** ▶ Passive cooling
- DRIVER DLM** ▶ Incl. standard xitanium driver.
- COLORS Δ** ▶
 - 3 = RAL 9003 black
 - 5 = RAL 9005 white
 - 6 = RAL 9006 alu
- ADJUSTABLE** ▶ No
- SIZE** ▶ 485 X 440MM

OPTIONS

- COLORS** ▶ Available in all RAL colours on request
Additional price + 10%.
Also available: color combinations
- DIMMABLE** ▶ Dimmable DALI € 45,00

INFORMATION

- WARRANTY** ▶ 5 Years

Δ = product color code. See colors

1.5m suspension set standard.

Keylight International B.V. reserves the right to modify or change technical, construction or LED specifications due to continuous improvements of our products and lightsources.



INDU LED

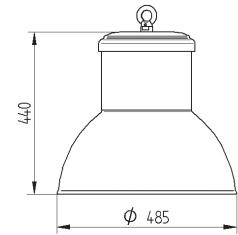

Technical drawing

| ARTICLE NO. | LAMP TYPE | BRAND | LIGHT OUTPUT | MODULE POWER | MODULE EFFICIENCY | CORRELATED COLOUR TEMPERATURE | COLOUR RENDERING INDEX | TC LIFE | SUSP. SET | SALES PRICE |
|--------------|-----------|---------|--------------|--------------|-------------------|-------------------------------|------------------------|---------|-----------|-------------|
| Δ see colors | | | LM | W | LM/W | K | RA | HRS | M | EURO |
| 7485.101.92Δ | DLM G5 | Philips | 1100 | 11 | 100 | 3000 | >80 | 50.000 | 1.5 | € 535,00 |
| 7485.102.92Δ | DLM G5 | Philips | 1100 | 10 | 110 | 4000 | >80 | 50.000 | 1.5 | € 535,00 |
| 7485.103.92Δ | DLM G5 | Philips | 2000 | 21 | 95 | 3000 | >80 | 50.000 | 1.5 | € 550,00 |
| 7485.104.92Δ | DLM G5 | Philips | 2000 | 19 | 105 | 4000 | >80 | 50.000 | 1.5 | € 550,00 |
| 7485.105.92Δ | DLM G5 | Philips | 3000 | 32 | 94 | 3000 | >80 | 50.000 | 1.5 | € 560,00 |
| 7485.106.92Δ | DLM G5 | Philips | 3000 | 29 | 103 | 4000 | >80 | 50.000 | 1.5 | € 560,00 |
| 7485.133.80Δ | DLM FOOD | Philips | 2700 | 43 | 65 | 3000 | >75 | 50.000 | 1.5 | € 795,00 |
| 7485.134.80Δ | DLM FOOD | Philips | 2700 | 41 | 75 | 4000 | >75 | 50.000 | 1.5 | € 795,00 |

WORK BAY



- PRODUCT MATERIAL** ▶ Steel, aluminium
- LIGHT SOURCE** ▶ Vossloh-Schwabe LUGA LED
- MODULE LIFETIME** ▶ Approx. 50.000 hours
- LED COOLING** ▶ Passive cooling
- DRIVER** ▶ Incl. driver
- COLORS (Δ)** ▶
 - 3 = RAL 9003 white
 - 5 = RAL 9005 black
 - 6 = RAL 9006 alu
- SIZE** ▶ 515 X 836MM

OPTIONS

- COLORS** ▶ Available in all RAL colours on request
Additional price + 10%
Also available: color combinations
- DIMMABLE** ▶ Dimmable DALI € 45,00

INFORMATION

- WARRANTY** ▶ 5 Years

Δ = product color code. See colors

1.5m suspension set standard.

Keylight International B.V. reserves the right to modify or change technical, construction or LED specifications due to continuous improvements of our products and lightsources.



WORK BAY

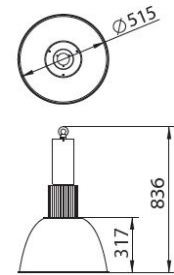

Technical drawing

| ARTICLE NO. | TYPE | LED TYPE | BRAND | LIGHT OUTPUT | MODULE POWER | MODULE EFFICIENCY | CORRELATED COLOUR TEMPERATURE | COLOUR RENDERING INDEX | TC LIFE | SALES PRICE |
|--------------|----------|----------|-----------------|--------------|--------------|-------------------|-------------------------------|------------------------|---------|-------------|
| Δ see colors | | | | LM | W | LM/W | K | RA | HRS | EURO |
| 7516.117.24Δ | LUGA LED | LV | Vossloh-Schwabe | 10.000 | 102 | 98 | 3000 | 80 | 50.000 | € 1225,00 |
| 7516.119.24Δ | LUGA LED | LV | Vossloh-Schwabe | 10.000 | 102 | 98 | 4000 | 80 | 50.000 | € 1225,00 |
| 7516.128.24Δ | LUGA LED | LV | Vossloh-Schwabe | 10.000 | 102 | 98 | 5000 | 80 | 50.000 | € 1225,00 |

CLASSIC BAY



- PRODUCT MATERIAL** ▶ Steel, aluminium and acryl
- LIGHT SOURCE** ▶ Fortimo SLM Gen4
- MODULE LIFETIME** ▶ Approx. 50.000 hours
- LED COOLING** ▶ Passive cooling
- DRIVER** ▶ Incl. xitanium driver
- COLORS (Δ)** ▶
 - 3 = RAL 9003 white
 - 5 = RAL 9005 black
 - 6 = RAL 9006 alu
- SIZE** ▶ 600 X 544MM

OPTIONS

- COLORS** ▶ Available in all RAL colours on request
Additional price + 10%
Also available: color combinations
- DIMMABLE** ▶ Dimmable DALI € 45,00

INFORMATION

- WARRANTY** ▶ 5 Years

Δ = product color code. See colors

1.5m suspension set standard.

Keylight International B.V. reserves the right to modify or change technical, construction or LED specifications due to continuous improvements of our products and lightsources.



CLASSIC BAY

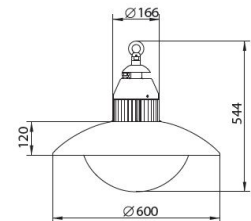

Technical drawing

| ARTICLE NO. | TYPE | LED TYPE | BRAND | LIGHT OUTPUT | MODULE POWER | MODULE EFFICIENCY | CORRELATED COLOUR TEMPERATURE | COLOUR RENDERING INDEX | TC LIFE | SALES PRICE |
|--------------|-----------------|----------|---------|--------------|--------------|-------------------|-------------------------------|------------------------|---------|-------------|
| Δ see colors | | | | LM | W | LM/W | K | RA | HRS | EURO |
| 7517.117.24Δ | SLM 3000-830 | G4 | Philips | 3000 | 26 | 118 | 3000 | 82 | 50.000 | € 785,00 |
| 7517.119.24Δ | SLM 3000-840 | G4 | Philips | 3000 | 26 | 126 | 4000 | 82 | 50.000 | € 785,00 |
| 7517.128.24Δ | SLM 3000-927 | G4 | Philips | 3000 | 26 | 92 | 2700 | 97 | 50.000 | € 785,00 |
| 7517.121.24Δ | SLM 3000-930 | G4 | Philips | 3000 | 26 | 95 | 3000 | 97 | 50.000 | € 785,00 |
| 7517.145.24Δ | SLM 3000-940 | G4 | Philips | 3000 | 26 | 103 | 3000 | 82 | 50.000 | € 785,00 |
| 7517.135.24Δ | SLM 4500-830 | G4 | Philips | 4500 | 42 | 115 | 3000 | 82 | 50.000 | € 795,00 |
| 7517.136.24Δ | SLM 4500-840 | G4 | Philips | 4500 | 42 | 123 | 4000 | 82 | 50.000 | € 795,00 |
| 7517.157.24Δ | SLM 4500-927 | G4 | Philips | 4500 | 42 | 90 | 2700 | 97 | 50.000 | € 795,00 |
| 7517.137.24Δ | SLM 4500-930 | G4 | Philips | 4500 | 42 | 93 | 3000 | 97 | 50.000 | € 795,00 |
| 7517.158.24Δ | SLM 4500-940 | G4 | Philips | 4500 | 42 | 101 | 3000 | 82 | 50.000 | € 795,00 |
| 7517.109.24Δ | SLM 3000 930 CW | G4 | Philips | 3000 | 34 | 88 | CRISP W | 92 | 50.000 | € 820,00 |
| 7517.110.24Δ | SLM 3800 930 CW | G4 | Philips | 3800 | 42 | 89 | CRISP W | 92 | 50.000 | € 835,00 |
| 7517.159.24Δ | SLM 2800 925 FW | G4 | Philips | 2800 | 42 | 65 | FOOD | 90 | 50.000 | € 845,00 |
| 7517.160.24Δ | SLM 3000 930 FR | G4 | Philips | 3000 | 42 | 70 | FOOD | 90 | 50.000 | € 845,00 |

TECHNICAL INFORMATION

PRODUCT

HIGH BAY



- PRODUCT MATERIAL** ▶ Aluminium
- LIGHT SOURCE** ▶ Cree
- MODULE LIFETIME** ▶ Approx. 50.000 hours
- LED COOLING** ▶ Passive cooling
- DRIVER** ▶ Incl. driver
- COLORS** ▶ ● 5 = RAL 9005 black
- SIZE** ▶ 450 X 410 X 372MM
- BEAM ANGLE** ▶ 60°

OPTIONS

- BEAM ANGLE** ▶ 45° or 90° on request
- COLOR TEMPERATURE** ▶ 2800, 3200, 5500, or 6500 on request

INFORMATION

- WARRANTY** ▶ 5 Years

Keylight International B.V. reserves the right to modify or change technical, construction or LED specifications due to continuous improvements of our products and lightsources.



HIGH BAY

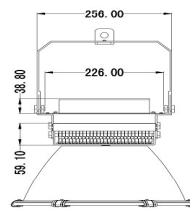

Technical drawing 100W

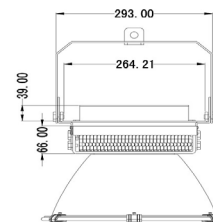

Technical drawing 150W

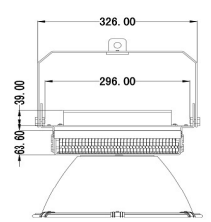

Technical drawing 200W

| ARTICLE NO. | LAMP TYPE | BRAND | LIGHT OUTPUT | MODULE POWER | MODULE EFFICIENCY | CORRELATED COLOUR TEMPERATURE | COLOUR RENDERING INDEX | TC LIFE | BEAM ANGLE | SALES PRICE |
|---------------|-----------|-------|--------------|--------------|-------------------|-------------------------------|------------------------|---------|------------|-------------|
| Δ see colors | | | LM | W | LM/W | K | RA | HRS | ° | EURO |
| 7300.181.91.5 | LED | Cree | 9500 | 100 | 95 | 4500 | 75-85 | 50.000 | 60 | € 495,00 |
| 7300.182.91.5 | LED | Cree | 13500 | 150 | 90 | 4500 | 75-85 | 50.000 | 60 | € 595,00 |
| 7300.181.91.5 | LED | Cree | 18500 | 200 | 92 | 4500 | 75-85 | 50.000 | 60 | € 725,00 |

TECHNICAL INFORMATION

PRODUCT

ORBIT 30 P



- PRODUCT MATERIAL** ▶ Steel and aluminium
- LIGHT SOURCE** ▶ Osram LEDPlate
- MODULE LIFETIME** ▶ Approx. 50.000 hours
- LED COOLING** ▶ Passive cooling
- DRIVER** ▶ Incl. standard Osram driver.
- COLORS (Δ)** ▶
 - 3 = RAL 9003 white
 - 5 = RAL 9005 black
 - 6 = RAL 9006 alu
- REFLECTOR PLATE** ▶ Opal diffuser
- ADJUSTABLE** ▶ No
- SIZE** ▶ 300 X 125MM

OPTIONS

- COLORS** ▶ Available in all RAL colours on request
Additional price + 10%
- DIMMABLE** ▶ Dimmable or dali € 45,00

INFORMATION

- WARRANTY** ▶ 5 Years

Δ see colors

1.5m suspension set standard.

Keylight International B.V. reserves the right to modify or change technical, construction or LED specifications due to continuous improvements of our products and lightsources.

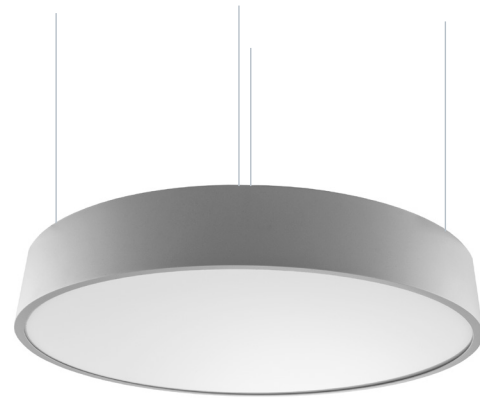

ORBIT 30 P

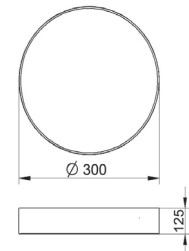

Technical drawing

| ARTICLE NO. | LAMP TYPE | BRAND | LIGHT OUTPUT | MODULE POWER | MODULE EFFICIENCY | CORRELATED COLOUR TEMPERATURE | COLOUR RENDERING INDEX | TC LIFE | SALES PRICE |
|--------------|-----------|-------|--------------|--------------|-------------------|-------------------------------|------------------------|---------|-------------|
| Δ see colors | | | LM | W | LM/W | K | RA | HRS | EURO |
| 7300.181.91Δ | LED plate | Osram | 1350 | 16 | 84 | 3000 | >80 | 50.000 | € 335,00 |
| 7300.182.91Δ | LED plate | Osram | 1900 | 23 | 83 | 3000 | >80 | 50.000 | € 335,00 |
| 7300.183.91Δ | LED plate | Osram | 2500 | 33 | 76 | 3000 | >80 | 50.000 | € 335,00 |
| 7300.184.91Δ | LED plate | Osram | 1400 | 16 | 87 | 4000 | >80 | 50.000 | € 335,00 |
| 7300.185.91Δ | LED plate | Osram | 2000 | 23 | 87 | 4000 | >80 | 50.000 | € 335,00 |
| 7300.186.91Δ | LED plate | Osram | 2600 | 33 | 79 | 4000 | >80 | 50.000 | € 335,00 |

TECHNICAL INFORMATION

PRODUCT

ORBIT 45 P



- PRODUCT MATERIAL** ▶ Steel and aluminium
- LIGHT SOURCE** ▶ Philips LEDLine
- MODULE LIFETIME** ▶ Approx. 50.000 hours
- LED COOLING** ▶ Passive cooling
- DRIVER** ▶ Incl. standard Philips driver.
- COLORS (Δ)** ▶
 - 3 = RAL 9003 white
 - 5 = RAL 9005 black
 - 6 = RAL 9006 alu
- REFLECTOR PLATE** ▶ Opal diffuser
- ADJUSTABLE** ▶ No
- SIZE** ▶ 425 X 125MM

OPTIONS

- COLORS** ▶ Available in all RAL colours on request
Additional price + 10%
- DIMMABLE** ▶ Dimmable or dali € 45,00

INFORMATION

- WARRANTY** ▶ 5 Years

Δ see colors

1.5m suspension set standard.

Keylight International B.V. reserves the right to modify or change technical, construction or LED specifications due to continuous improvements of our products and lightsources.

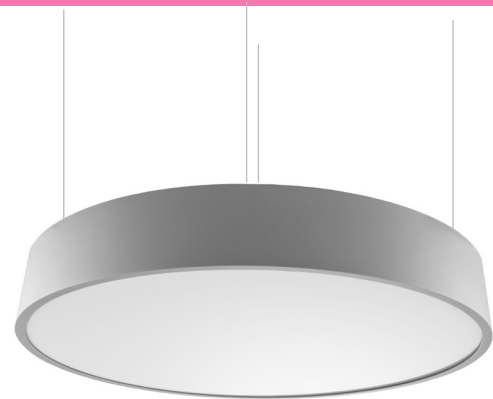

ORBIT 45 P

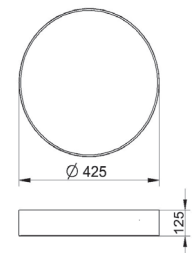

Technical drawing

| ARTICLE NO. | LAMP TYPE | BRAND | LIGHT OUTPUT | MODULE POWER | MODULE EFFICIENCY | CORRELATED COLOUR TEMPERATURE | COLOUR RENDERING INDEX | TC LIFE | SALES PRICE |
|--------------|-----------|---------|--------------|--------------|-------------------|-------------------------------|------------------------|---------|-------------|
| Δ see colors | | | LM | W | LM/W | K | RA | HRS | EURO |
| 7425.195.91Δ | LEDLine | Philips | 2600 | 19 | 137 | 3000 | >80 | 50.000 | € 395,00 |
| 7425.196.91Δ | LEDLine | Philips | 2600 | 19 | 137 | 4000 | >80 | 50.000 | € 395,00 |

TECHNICAL INFORMATION

PRODUCT

ORBIT 65 P



- PRODUCT MATERIAL** ▶ Steel and aluminium
- LIGHT SOURCE** ▶ Philips LEDLine
- MODULE LIFETIME** ▶ Approx. 50.000 hours
- LED COOLING** ▶ Passive cooling
- DRIVER** ▶ Incl. standard Philips driver.
- COLORS (Δ)** ▶
 - 3 = RAL 9003 white
 - 5 = RAL 9005 black
 - 6 = RAL 9006 alu
- REFLECTOR PLATE** ▶ Opal diffuser
- ADJUSTABLE** ▶ No
- SIZE** ▶ 650 X 112MM

OPTIONS

- COLORS** ▶ Available in all RAL colours on request
Additional price + 10%
- DIMMABLE** ▶ Dimmable or dali € 45,00

INFORMATION

- WARRANTY** ▶ 5 Years

Δ see colors

1.5m suspension set standard.

Keylight International B.V. reserves the right to modify or change technical, construction or LED specifications due to continuous improvements of our products and lightsources.



ORBIT 65 P

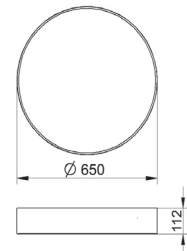

Technical drawing

| ARTICLE NO. | LAMP TYPE | BRAND | LIGHT OUTPUT | MODULE POWER | MODULE EFFICIENCY | CORRELATED COLOUR TEMPERATURE | COLOUR RENDERING INDEX | TC LIFE | SALES PRICE |
|--------------|-----------|---------|--------------|--------------|-------------------|-------------------------------|------------------------|---------|-------------|
| Δ see colors | | | LM | W | LM/W | K | RA | HRS | EURO |
| 5650.195.91Δ | LEDLine | Philips | 5200 | 37 | 140 | 3000 | >80 | 50.000 | € 765,00 |
| 5650.196.91Δ | LEDLine | Philips | 5200 | 37 | 140 | 4000 | >80 | 50.000 | € 765,00 |

TECHNICAL INFORMATION

PRODUCT

ORBIT 90 P



- PRODUCT MATERIAL** ▶ Steel and aluminium
- LIGHT SOURCE** ▶ Philips LEDLine
- MODULE LIFETIME** ▶ Approx. 50.000 hours
- LED COOLING** ▶ Passive cooling
- DRIVER** ▶ Incl. standard Philips driver.
- COLORS (Δ)** ▶
 - 3 = RAL 9003 white
 - 5 = RAL 9005 black
 - 6 = RAL 9006 alu
- REFLECTOR PLATE** ▶ Opal diffuser
- ADJUSTABLE** ▶ No
- SIZE** ▶ 900 X 112MM

OPTIONS

- COLORS** ▶ Available in all RAL colours on request
Additional price + 10%
- DIMMABLE** ▶ Dimmable or dali on request € 45,00

INFORMATION

- WARRANTY** ▶ 5 Years

Δ see colors

1.5m suspension set standard.

Keylight International B.V. reserves the right to modify or change technical, construction or LED specifications due to continuous improvements of our products and lightsources.



ORBIT 90 P

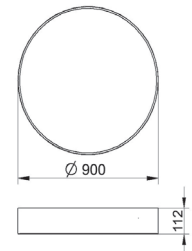

Technical drawing

| ARTICLE NO. | LAMP TYPE | BRAND | LIGHT OUTPUT | MODULE POWER | MODULE EFFICIENCY | CORRELATED COLOUR TEMPERATURE | COLOUR RENDERING INDEX | TC LIFE | SALES PRICE |
|--------------|-----------|---------|--------------|--------------|-------------------|-------------------------------|------------------------|---------|-------------|
| Δ see colors | | | LM | W | LM/W | K | RA | HRS | EURO |
| 7900.193.91Δ | LEDLine | Philips | 10.000 | 80 | 125 | 3000 | >80 | 50.000 | € 1120,00 |
| 7900.194.91Δ | LEDLine | Philips | 10.000 | 80 | 125 | 4000 | >80 | 50.000 | € 1120,00 |

TECHNICAL INFORMATION

PRODUCT

ROUNDY 12+15



- PRODUCT MATERIAL** ▶ Steel and aluminium
- LIGHT SOURCE** ▶ LED Stripes
- MODULE LIFETIME** ▶ Approx. 35.000 hours
- LED COOLING** ▶ Passive cooling
- DRIVER** ▶ Incl. standard Philips driver.
- COLORS (Δ)** ▶
 - 3 = RAL 9003 white
 - 5 = RAL 9005 black
 - 6 = RAL 9006 alu
- REFLECTOR PLATE** ▶ Opal diffuser
- ADJUSTABLE** ▶ No
- SIZE** ▶ 1200 / 1500 X 112MM

OPTIONS

- COLORS** ▶ Available in all RAL colours on request
Additional price + 10%
- DIMMABLE** ▶ Dimmable or dali € 45,00

INFORMATION

- WARRANTY** ▶ 5 Years

Δ see colors

1.5m suspension set standard.

Keylight International B.V. reserves the right to modify or change technical, construction or LED specifications due to continuous improvements of our products and lightsources.



ROUNDY

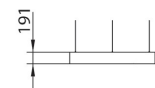
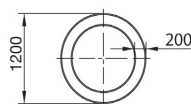

Technical drawing (1200mm)

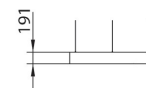
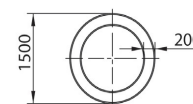

Technical drawing (1500mm)

| ARTICLE NO. | LAMP TYPE | BRAND | LIGHT OUTPUT | MODULE POWER | MODULE EFFICIENCY | CORRELATED COLOUR TEMPERATURE | COLOUR RENDERING INDEX | TC LIFE | SIZE | SALES PRICE |
|------------------|------------|-------|--------------|--------------|-------------------|-------------------------------|------------------------|---------|------|-------------|
| ROUNDY 12 | | | | | | | | | | |
| Δ see colors | | | LM | W | LM/W | K | RA | HRS | MM | EURO |
| 7150.193.91Δ | LED Stripe | KL | | 75 | | 3000 | >80 | 50.000 | 1200 | € 2450,00 |
| 7150.194.91Δ | LED Stripe | KL | | 75 | | 4000 | >80 | 50.000 | 1200 | € 2450,00 |

| ARTICLE NO. | LAMP TYPE | BRAND | LIGHT OUTPUT | MODULE POWER | MODULE EFFICIENCY | CORRELATED COLOUR TEMPERATURE | COLOUR RENDERING INDEX | TC LIFE | SIZE | SALES PRICE |
|------------------|------------|-------|--------------|--------------|-------------------|-------------------------------|------------------------|---------|------|-------------|
| ROUNDY 15 | | | | | | | | | | |
| Δ see colors | | | LM | W | LM/W | K | RA | HRS | MM | EURO |
| 7149.193.91Δ | LED Stripe | KL | | 90 | | 3000 | >80 | 50.000 | 1500 | € 2625,00 |
| 7149.194.91Δ | LED Stripe | KL | | 90 | | 4000 | >80 | 50.000 | 1500 | € 2625,00 |

TECHNICAL INFORMATION

PRODUCT

QUADRANT 70



- PRODUCT MATERIAL** ▶ Steel and aluminium
- LIGHT SOURCE** ▶ Philips LEDLine
- MODULE LIFETIME** ▶ Approx. 50.000 hours
- LED COOLING** ▶ Passive cooling
- DRIVER** ▶ Incl. standard Philips driver.
- COLORS (Δ)** ▶
 - 3 = RAL 9003 white
 - 5 = RAL 9005 black
 - 6 = RAL 9006 alu
- REFLECTOR PLATE** ▶ Opal diffuser
- ADJUSTABLE** ▶ No
- SIZE** ▶ 720 X 720 X 155MM

OPTIONS

- COLORS** ▶ Available in all RAL colours on request
Additional price + 10%
- DIMMABLE** ▶ Dimmable or dali € 45,00

INFORMATION

- WARRANTY** ▶ 5 Years

Δ see colors

1.5m suspension set standard.

Keylight International B.V. reserves the right to modify or change technical, construction or LED specifications due to continuous improvements of our products and lightsources.



QUADRANT 70

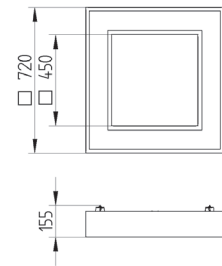

Technical drawing

| ARTICLE NO. | LAMP TYPE | BRAND | LIGHT OUTPUT | MODULE POWER | MODULE EFFICIENCY | CORRELATED COLOUR TEMPERATURE | COLOUR RENDERING INDEX | TC LIFE | SALES PRICE |
|--------------|-----------|---------|--------------|--------------|-------------------|-------------------------------|------------------------|---------|-------------|
| Δ see colors | | | LM | W | LM/W | K | RA | HRS | EURO |
| 7720.197.91Δ | LEDLine | Philips | 8800 | 65 | 135 | 3000 | >80 | 50.000 | € 875,00 |
| 7720.198.91Δ | LEDLine | Philips | 8800 | 65 | 135 | 4000 | >80 | 50.000 | € 875,00 |

TECHNICAL INFORMATION

PRODUCT

QUADRANT 90



- PRODUCT MATERIAL** ▶ Steel and aluminium
- LIGHT SOURCE** ▶ Philips LEDLine
- MODULE LIFETIME** ▶ Approx. 50.000 hours
- LED COOLING** ▶ Passive cooling
- DRIVER** ▶ Incl. standard Philips driver.
- COLORS (Δ)** ▶
 - 3 = RAL 9003 white
 - 5 = RAL 9005 black
 - 6 = RAL 9006 alu
- REFLECTOR PLATE** ▶ Opal diffuser
- ADJUSTABLE** ▶ No
- SIZE** ▶ 900 X 900 X 123MM

OPTIONS

- COLORS** ▶ Available in all RAL colours on request
Additional price + 10%
- DIMMABLE** ▶ Dimmable or dali € 45,00

INFORMATION

- WARRANTY** ▶ 5 Years

Δ see colors

1.5m suspension set standard.

Keylight International B.V. reserves the right to modify or change technical, construction or LED specifications due to continuous improvements of our products and lightsources.



QUADRANT 90

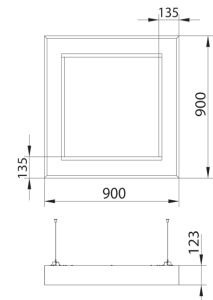

Technical drawing

| ARTICLE NO. | LAMP TYPE | BRAND | LIGHT OUTPUT | MODULE POWER | MODULE EFFICIENCY | CORRELATED COLOUR TEMPERATURE | COLOUR RENDERING INDEX | TC LIFE | SALES PRICE |
|--------------|-----------|---------|--------------|--------------|-------------------|-------------------------------|------------------------|---------|-------------|
| Δ see colors | | | LM | W | LM/W | K | RA | HRS | EURO |
| 7901.197.91Δ | LEDLine | Philips | 13.200 | 98 | 135 | 3000 | >80 | 50.000 | € 1225,00 |
| 7901.198.91Δ | LEDLine | Philips | 13.200 | 98 | 135 | 4000 | >80 | 50.000 | € 1225,00 |



**Wall
Luminaires**



SATURNUS R + S
PAGE 1



BLOCK C UD
PAGE 1



BLOCK O
PAGE 1



BLOCK W
PAGE 1



BLOCK S
PAGE 1



LOOK
PAGE 1



CASE
PAGE 1



BLOCK H
PAGE 1



BLOCK U
PAGE 1



WAVE
PAGE 1



BRIDGE
PAGE 1



SUNSET
PAGE 1

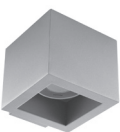

BLOXX W 10
PAGE 1



BOXX 12
PAGE 1



VERO
PAGE 1

Wall Luminaires

| | |
|------------|--------|
| UTAH 18 | PAGE 1 |
| YORK | PAGE 1 |
| DL 180 | PAGE 1 |
| KANSAS 16 | PAGE 1 |
| DEEP 22 | PAGE 1 |
| VISION 15 | PAGE 1 |
| VISION 20 | PAGE 1 |
| ROLED | PAGE 1 |
| CAP R1 | PAGE 1 |
| CAP R2 | PAGE 1 |
| LINKON 13 | PAGE 1 |
| LINKON 14L | PAGE 1 |
| UTAH 22 | PAGE 1 |
| UTAH 18 | PAGE 1 |
| YORK | PAGE 1 |
| DL 180 | PAGE 1 |

TECHNICAL INFORMATION

PRODUCT

SATURNUS R + S



- PRODUCT MATERIAL** ▶ Aluminium
- LIGHT SOURCE** ▶ XP-E
- MODULE LIFETIME** ▶ Approx. 30.000 hours
- LED COOLING** ▶ Passive cooling
- DRIVER** ▶ Incl. standard dimmable driver
- COLORS (Δ)** ▶ ● 3 = RAL 9003 white
- SIZE ROUND** ▶ 52 X 57 X 15MM
- SIZE SQUARE** ▶ 50 X 57 X 15MM

INFORMATION

- WARRANTY** ▶ 2 Years

Including:

- 10 CM wire to connection block
- 10 CM wire to driver
- Driver size is 40 x 40 x 20mm
- 1 meter wire with plug

Δ = product color code. See colors

Keylight International B.V. reserves the right to modify or change technical, construction or LED specifications due to continuous improvements of our products and lightsources.



LOOK

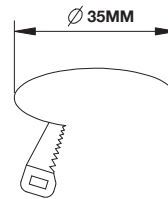

Hole size

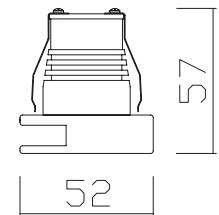

Technical drawing (round)

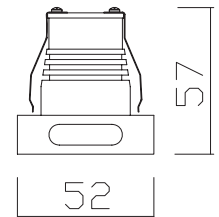

Technical drawing (square)

| ARTICLE NO. | LAMP TYPE | BRAND | LIGHT OUTPUT | MODULE POWER | MODULE EFFICIENCY | CORRELATED COLOUR TEMPERATURE | COLOUR RENDERING INDEX | TC LIFE | MA | SALES PRICE |
|----------------|-----------|-------|--------------|--------------|-------------------|-------------------------------|------------------------|---------|-----|-------------|
| Δ see colors | | | LM | W | LM/W | K | RA | HRS | mA | EURO |
| 6052.990.99.3R | XP-E | Cree | 21 | 1.2 | 21 | 2700 | >80 | 30.000 | 350 | € 60,00 |
| 6050.990.99.3S | XP-E | Cree | 21 | 1.2 | 21 | 2700 | >80 | 30.000 | 350 | € 60,00 |

TECHNICAL INFORMATION

PRODUCT

BLOCK C UD



- PRODUCT MATERIAL** ▶ Die-cast aluminium
- LIGHT SOURCE** ▶ XP-E
- MODULE LIFETIME** ▶ Approx. 30.000 hours
- LED COOLING** ▶ Passive cooling
- DRIVER** ▶ Incl. driver.
- COLORS (Δ)** ▶
 - 3 = RAL 9003 white
 - 5 = RAL 9005 black
- BEAM ANGLE** ▶ 30°
- SIZE** ▶ 120 X 78 X 70MM

INFORMATION

- WARRANTY** ▶ 5 Years

Δ = product color code. See colors



BLOCK C UD

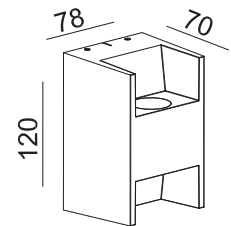

Technical drawing

Keylight International B.V. reserves the right to modify or change technical, construction or LED specifications due to continuous improvements of our products and lightsources.

| ARTICLE NO. | LAMP TYPE | BRAND | LIGHT OUTPUT | MODULE POWER | MODULE EFFICIENCY | CORRELATED COLOUR TEMPERATURE | COLOUR RENDERING INDEX | TC LIFE | MA | SALES PRICE |
|--------------|-----------|-------|--------------|--------------|-------------------|-------------------------------|------------------------|---------|-----|-------------|
| Δ see colors | | | LM | W | LM/W | K | RA | HRS | mA | EURO |
| 6013.990.30Δ | XP-E | Cree | 280 | 2 X 2.5 | 112 | 2700 | >80 | 30.000 | 700 | € 125,00 |

TECHNICAL INFORMATION

PRODUCT

BLOCK O



- PRODUCT MATERIAL** ▶ Die-cast aluminium
- LIGHT SOURCE** ▶ XP-E
- MODULE LIFETIME** ▶ Approx. 30.000 hours
- LED COOLING** ▶ Passive cooling
- DRIVER** ▶ Incl. driver.
- COLORS (Δ)** ▶
 - 3 = RAL 9003 white
 - 5 = RAL 9005 black
- BEAM ANGLE** ▶ 30°
- SIZE** ▶ 80 X 85 X 70MM

INFORMATION

- WARRANTY** ▶ 5 Years

Δ = product color code. See colors



BLOCK O

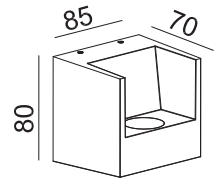

Technical drawing

Keylight International B.V. reserves the right to modify or change technical, construction or LED specifications due to continuous improvements of our products and lightsources.

| ARTICLE NO. | LAMP TYPE | BRAND | LIGHT OUTPUT | MODULE POWER | MODULE EFFICIENCY | CORRELATED COLOUR TEMPERATURE | COLOUR RENDERING INDEX | TC LIFE | mA | SALES PRICE |
|--------------|-----------|-------|--------------|--------------|-------------------|-------------------------------|------------------------|---------|-----|-------------|
| Δ see colors | | | LM | W | LM/W | K | RA | HRS | mA | EURO |
| 6800.990.30Δ | XP-E | Cree | 280 | 2.5 | 112 | 3000 | >80 | 30.000 | 700 | € 85,00 |

TUMBLE 'N DRY' □

TUMBLE 'N DRY' □



TECHNICAL INFORMATION

PRODUCT

BLOCK W



- PRODUCT MATERIAL** ▶ Aluminium
- LIGHT SOURCE** ▶ XM-L
- MODULE LIFETIME** ▶ Approx. 30.000 hours
- LED COOLING** ▶ Passive cooling
- DRIVER** ▶ Incl. driver.
- COLORS (Δ)** ▶
 - 3 = RAL 9003 white
 - 5 = RAL 9005 black
 - 9 = Alu brushed - white inside
- SIZE** ▶ 102 X 102 X 58MM

INFORMATION

- WARRANTY** ▶ 5 Years

Δ = product color code. See colors



BLOCK W

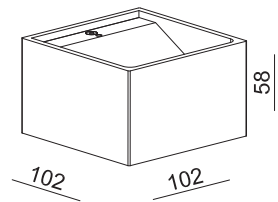

Technical drawing

Keylight International B.V. reserves the right to modify or change technical, construction or LED specifications due to continuous improvements of our products and lightsources.

| ARTICLE NO. | LAMP TYPE | BRAND | LIGHT OUTPUT | MODULE POWER | MODULE EFFICIENCY | CORRELATED COLOUR TEMPERATURE | COLOUR RENDERING INDEX | TC LIFE | mA | SALES PRICE |
|--------------|-----------|-------|--------------|--------------|-------------------|-------------------------------|------------------------|---------|-----|-------------|
| Δ see colors | | | LM | W | LM/W | K | RA | HRS | mA | EURO |
| 6102.990.99Δ | XM-L | Cree | 320 | 4 | 80 | 3000 | >80 | 30.000 | 350 | € 120,00 |

BLOCK S



- PRODUCT MATERIAL** ▶ Aluminium
- LIGHT SOURCE** ▶ XM-L
- MODULE LIFETIME** ▶ Approx. 30.000 hours
- LED COOLING** ▶ Passive cooling
- DRIVER** ▶ Incl. driver.
- COLORS (Δ)** ▶
 - 3 = RAL 9003 white
 - 5 = RAL 9005 black
 - 9 = Alu brushed - white inside
- SIZE** ▶ 102 X 102 X 102MM

OPTIONS

- DIMMABLE** ▶ Dimmable build-in trailing edge € 55,00
art. no.: 0135.999.99
- ACCESSOIRES** ▶ Incl. 3 different beam width covers

INFORMATION

- WARRANTY** ▶ 5 Years

Δ = product color code. See colors



BLOCK S

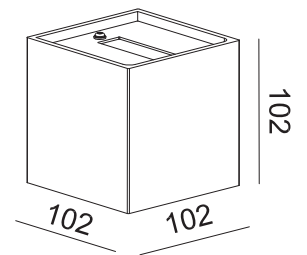

Technical drawing

Keylight International B.V. reserves the right to modify or change technical, construction or LED specifications due to continuous improvements of our products and lightsources.

| ARTICLE NO. | LAMP TYPE | BRAND | LIGHT OUTPUT | MODULE POWER | MODULE EFFICIENCY | CORRELATED COLOUR TEMPERATURE | COLOUR RENDERING INDEX | TC LIFE | mA | SALES PRICE |
|--------------|-----------|-------|--------------|--------------|-------------------|-------------------------------|------------------------|---------|-----|-------------|
| Δ see colors | | | LM | W | LM/W | K | RA | HRS | mA | EURO |
| 6012.990.99Δ | XM-L | Cree | 320 | 4 | 80 | 2700 | >80 | 30.000 | 350 | € 130,00 |

TECHNICAL INFORMATION

PRODUCT

LOOK



- PRODUCT MATERIAL** ▶ Die-cast aluminium
- LIGHT SOURCE** ▶ V8 Array
- MODULE LIFETIME** ▶ Approx. 30.000 hours
- LED COOLING** ▶ Passive cooling
- DRIVER** ▶ Incl. standard driver
- COLORS (Δ)** ▶
 - = RAL 9005 black
 - + ● = 35 = Black & white
 - + ● = 65 = Gray & black
- BEAM ANGLE** ▶ 32°
- ADJUSTABLE** ▶ 350° rotational
90° rotational spot head
- SIZE** ▶ 100 X 103MM. See technical drawing

OPTIONS

- DIMMABLE** ▶ Dimmable build-in trailing edge € 55,00
art. no.: 0135.999.99

INFORMATION

- WARRANTY** ▶ 5 Years

Δ = product color code. See colors

Keylight International B.V. reserves the right to modify or change technical, construction or LED specifications due to continuous improvements of our products and lightsources.



LOOK

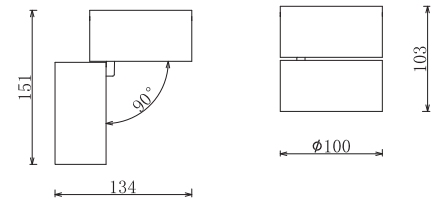

Technical drawing

| ARTICLE NO. | LAMP TYPE | BRAND | LIGHT OUTPUT | MODULE POWER | MODULE EFFICIENCY | CORRELATED COLOUR TEMPERATURE | COLOUR RENDERING INDEX | TC LIFE | mA | SALES PRICE |
|--------------|-----------|-----------|--------------|--------------|-------------------|-------------------------------|------------------------|---------|-----|-------------|
| Δ see colors | | | LM | W | LM/W | K | RA | HRS | | EURO |
| 6019.999.23Δ | V8 Array | Bridgelux | 970 | 9.3 | 113 | 2700 | >80 | 30.000 | 500 | € 155,00 |

CASE



- PRODUCT MATERIAL** ▶ Aluminium
- LIGHT SOURCE** ▶ LED
- MODULE LIFETIME** ▶ Approx. 50.000 hours
- LED COOLING** ▶ Passive cooling
- DRIVER** ▶ Incl. driver.
- COLORS (Δ)** ▶
 - 3 = RAL 9003 white
 - 5 = RAL 9005 black
 - 9 = Alu brushed - white inside
- SIZE** ▶ 120 X 120 X 50MM

INFORMATION

- WARRANTY** ▶ 5 Years

Δ = product color code. See colors



CASE

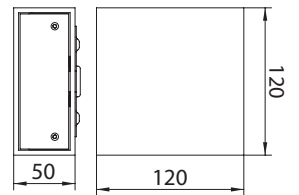

Technical drawing

Keylight International B.V. reserves the right to modify or change technical, construction or LED specifications due to continuous improvements of our products and lightsources.

| ARTICLE NO. | LAMP TYPE | BRAND | LIGHT OUTPUT | MODULE POWER | MODULE EFFICIENCY | CORRELATED COLOUR TEMPERATURE | COLOUR RENDERING INDEX | TC LIFE | SALES PRICE |
|--------------|-----------|-------|--------------|--------------|-------------------|-------------------------------|------------------------|---------|-------------|
| Δ see colors | | | LM | W | LM/W | K | RA | HRS | EURO |
| 6015.981.99Δ | XML | LED | 2X 300 | 6 | 50 | 2700 | >80 | 50.000 | € 155,00 |
| 6015.982.99Δ | XML | LED | 2x 320 | 6 | 53 | 3000 | >80 | 50.000 | € 155,00 |
| 6015.983.99Δ | XML | LED | 2X 340 | 6 | 56 | 4000 | >80 | 50.000 | € 155,00 |

TECHNICAL INFORMATION

PRODUCT

BLOCK H



- PRODUCT MATERIAL** ▶ Aluminium
- LIGHT SOURCE** ▶ XM-L
- MODULE LIFETIME** ▶ Approx. 30.000 hours
- LED COOLING** ▶ Passive cooling
- DRIVER** ▶ Incl. driver.
- COLORS (Δ)** ▶
 - = RAL 9003 white **3** = RAL 9003 white
 - + ● = 9005 black. Gold inside **59** = 9005 black. Gold inside
- SIZE** ▶ 125 X 125 X 80MM

OPTIONS

- DIMMABLE** ▶ Dimmable build-in trailing edge € 55,00
art. no.: 0135.999.99

INFORMATION

- WARRANTY** ▶ 5 Years

Δ = product color code. See colors

Keylight International B.V. reserves the right to modify or change technical, construction or LED specifications due to continuous improvements of our products and lightsources.

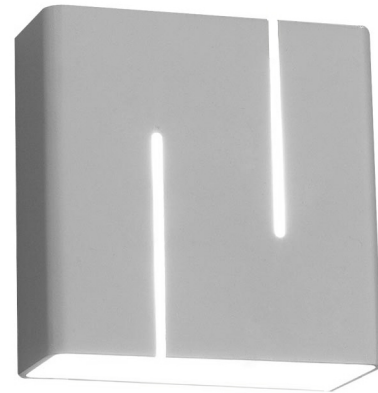

BLOCK H

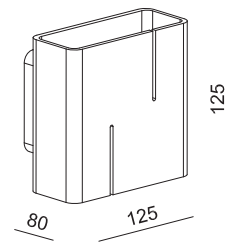

Technical drawing

| ARTICLE NO. | LAMP TYPE | BRAND | LIGHT OUTPUT | MODULE POWER | MODULE EFFICIENCY | CORRELATED COLOUR TEMPERATURE | COLOUR RENDERING INDEX | TC LIFE | MA | SALES PRICE |
|--------------|-----------|-------|--------------|--------------|-------------------|-------------------------------|------------------------|---------|-----|-------------|
| Δ see colors | | | LM | W | LM/W | K | RA | HRS | MA | EURO |
| 6080.990.99Δ | XM-L | Cree | 320 | 4 | 80 | 3000 | >80 | 30.000 | 350 | € 130,00 |

BLOCK U



- PRODUCT MATERIAL** ▶ Die-cast aluminium
- LIGHT SOURCE** ▶ SMD LED
- MODULE LIFETIME** ▶ Approx. 30.000 hours
- LED COOLING** ▶ Passive cooling
- DRIVER** ▶ Incl. driver.
- COLORS (Δ)** ▶ ● + ● 35 = Black & white
- ADJUSTABLE** ▶ 180° vertically adjustable
- SIZE** ▶ 123 X 125 X 80MM

INFORMATION

- WARRANTY** ▶ 5 Years

Δ = product color code. See colors



BLOCK U

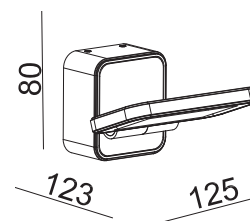

Technical drawing

Keylight International B.V. reserves the right to modify or change technical, construction or LED specifications due to continuous improvements of our products and lightsources.

| ARTICLE NO. | LAMP TYPE | BRAND | LIGHT OUTPUT | MODULE POWER | MODULE EFFICIENCY | CORRELATED COLOUR TEMPERATURE | COLOUR RENDERING INDEX | TC LIFE | SALES PRICE |
|----------------|-----------|-----------|--------------|--------------|-------------------|-------------------------------|------------------------|---------|-------------|
| | | | LM | W | LM/W | K | RA | HRS | EURO |
| 6086.990.99.35 | SMD LED | Everlight | 600 | 8 | 75 | 3000 | >80 | 30.000 | € 135,00 |

TECHNICAL INFORMATION

PRODUCT

WAVE



- ▶ **PRODUCT MATERIAL** Aluminium
- ▶ **LIGHT SOURCE** XM-L
- ▶ **MODULE LIFETIME** Approx. 30.000 hours
- ▶ **LED COOLING** Passive cooling
- ▶ **DRIVER** Incl. driver.
- ▶ **COLORS (Δ)**
 - 3 = RAL 9003 white
 - 5 = RAL 9005 black
- ▶ **SIZE** 120 X 107 X 200MM

OPTIONS

- ▶ **DIMMABLE** Dimmable build-in trailing edge € 55,00
art. no.: 0135.999.99

INFORMATION

- ▶ **WARRANTY** 5 Years

Δ = product color code. See colors

Keylight International B.V. reserves the right to modify or change technical, construction or LED specifications due to continuous improvements of our products and lightsources.



WAVE

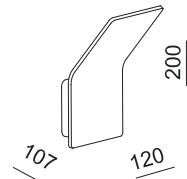

Technical drawing

| ARTICLE NO. | LAMP TYPE | BRAND | LIGHT OUTPUT | MODULE POWER | MODULE EFFICIENCY | CORRELATED COLOUR TEMPERATURE | COLOUR RENDERING INDEX | TC LIFE | MA | SALES PRICE |
|---------------|-----------|-------|--------------|--------------|-------------------|-------------------------------|------------------------|---------|-----|-------------|
| Δ see colors | | | LM | W | LM/W | K | RA | HRS | MA | EURO |
| 6082.990.99.Δ | XM-L | Cree | 280 | 4 | 70 | 2700 | >80 | 30.000 | 350 | € 135,00 |

TECHNICAL INFORMATION

PRODUCT

BRIDGE



- PRODUCT MATERIAL** ▶ Aluminium
- LIGHT SOURCE** ▶ XM-L
- MODULE LIFETIME** ▶ Approx. 30.000 hours
- LED COOLING** ▶ Passive cooling
- DRIVER** ▶ Incl. driver.
- COLORS (Δ)** ▶
 - = RAL 9003 white
 - + ● = 59 = 9005 black. Gold inside
- SIZE** ▶ 150 X 90 X 90MM

OPTIONS

- DIMMABLE** ▶ Dimmable build-in trailing edge € 55,00
art. no.: 0135.999.99

INFORMATION

- WARRANTY** ▶ 5 Years

Δ = product color code. See colors

Keylight International B.V. reserves the right to modify or change technical, construction or LED specifications due to continuous improvements of our products and lightsources.



BRIDGE

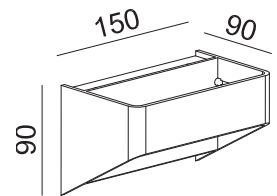

Technical drawing

| ARTICLE NO. | LAMP TYPE | BRAND | LIGHT OUTPUT | MODULE POWER | MODULE EFFICIENCY | CORRELATED COLOUR TEMPERATURE | COLOUR RENDERING INDEX | TC LIFE | MA | SALES PRICE |
|---------------|-----------|-------|--------------|--------------|-------------------|-------------------------------|------------------------|---------|-----|-------------|
| Δ see colors | | | LM | W | LM/W | K | RA | HRS | MA | EURO |
| 6081.990.99.Δ | XM-L | Cree | 280 | 4 | 70 | 3000 | >80 | 30.000 | 350 | € 140,00 |

TECHNICAL INFORMATION

PRODUCT

SUNSET



- ▶ **PRODUCT MATERIAL** Aluminium + glass
- ▶ **LIGHT SOURCE** M-Zenigata
- ▶ **MODULE LIFETIME** Approx. 30.000 hours
- ▶ **LED COOLING** Passive cooling
- ▶ **DRIVER** Incl. driver.
- ▶ **COLORS (Δ)**
 - = RAL 9003 white
 - + ● = 59 = 9005 black. Gold inside
- ▶ **SIZE** 175 X 80 X 90MM

OPTIONS

- ▶ **DIMMABLE** Dimmable build-in trailing edge € 55,00
art. no.: 0135.999.99

INFORMATION

- ▶ **WARRANTY** 5 Years

Δ = product color code. See colors

Keylight International B.V. reserves the right to modify or change technical, construction or LED specifications due to continuous improvements of our products and lightsources.



SUNSET

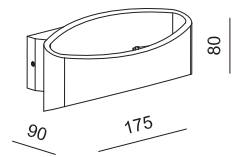

Technical drawing

| ARTICLE NO. | LAMP TYPE | BRAND | LIGHT OUTPUT | MODULE POWER | MODULE EFFICIENCY | CORRELATED COLOUR TEMPERATURE | COLOUR RENDERING INDEX | TC LIFE | mA | SALES PRICE |
|--------------|------------|-------|--------------|--------------|-------------------|-------------------------------|------------------------|---------|-----|-------------|
| Δ see colors | | | LM | W | LM/W | K | RA | HRS | mA | EURO |
| 6021.999.99Δ | M-Zenigata | Sharp | 380 | 5 | 76 | 3000 | >80 | 30.000 | 700 | € 130,00 |

BLOXX W 10



- PRODUCT MATERIAL** ▶ Steel and aluminium
- LIGHT SOURCE** ▶ LED Disk
- MODULE LIFETIME** ▶ Approx. 50.000 hours
- LED COOLING** ▶ Passive cooling
- DRIVER** ▶ Integrated driver
- COLORS (Δ)** ▶
 - 3 = RAL 9003 white
 - 5 = RAL 9005 black
 - 6 = RAL 9006 alu
- BEAM ANGLE** ▶ 80°
- SIZE** ▶ 110 X 130 X 87MM

OPTIONS

- COLORS** ▶ Available in all RAL colours on request
Additional price + 10%
- DIMMABLE** ▶ Standard dimmable leading edge

INFORMATION

- WARRANTY** ▶ 5 Years

Δ = product color code. See colors

Keylight International B.V. reserves the right to modify or change technical, construction or LED specifications due to continuous improvements of our products and lightsources.

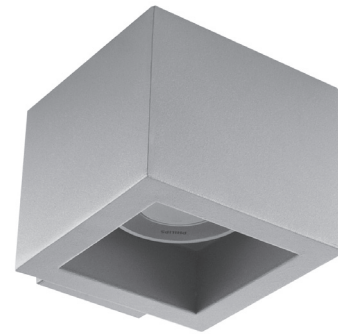

BLOXX W 10

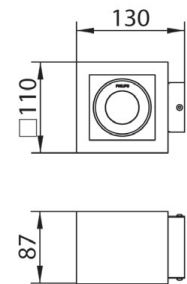

Technical drawing

| ARTICLE NO. | LAMP TYPE | BRAND | LIGHT OUTPUT | MODULE POWER | MODULE EFFICIENCY | CORRELATED COLOUR TEMPERATURE | COLOUR RENDERING INDEX | TC LIFE | POWER FACTOR | SALES PRICE |
|--------------|-----------|---------|--------------|--------------|-------------------|-------------------------------|------------------------|---------|--------------|-------------|
| Δ see colors | | | LM | W | LM/W | K | RA | HRS | PF | EURO |
| 6014.141.80Δ | Disk G3 | Philips | 800 | 12 | 68 | 2700 | >80 | 50.000 | >,09 | € 150,00 |
| 6014.142.80Δ | Disk G3 | Philips | 800 | 12 | 68 | 3000 | >80 | 50.000 | >,09 | € 150,00 |
| 6014.142.80Δ | Disk G3 | Philips | 850 | 11 | 72 | 4000 | >80 | 50.000 | >,09 | € 150,00 |

TECHNICAL INFORMATION

PRODUCT

BOXX 12



- PRODUCT MATERIAL** ▶ Steel and aluminium
- LIGHT SOURCE** ▶ SLM G4
- MODULE LIFETIME** ▶ Approx. 50.000 hours
- LED COOLING** ▶ Passive cooling
- DRIVER** ▶ Incl. Xitanium driver.
- COLORS (Δ)** ▶
 - 3 = RAL 9003 white
 - 5 = RAL 9005 black
 - 6 = RAL 9006 alu
- BEAM ANGLE** ▶ 30°
- SIZE** ▶ 185 X 235MM

OPTIONS

- COLORS** ▶ Available in all RAL colours on request.
Additional price + 10%
- DIMMABLE** ▶ Dimmable or dali € 45,00

INFORMATION

- WARRANTY** ▶ 5 Years

Δ = product color code. See colors

Keylight International B.V. reserves the right to modify or change technical, construction or LED specifications due to continuous improvements of our products and lightsources.

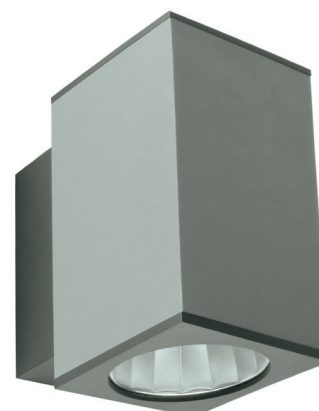

BOXX 12

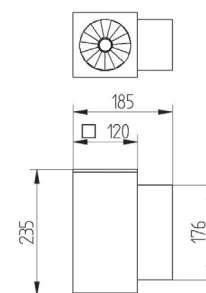

Technical drawing

| ARTICLE NO. | TYPE | LED TYPE | BRAND | LIGHT OUTPUT | MODULE POWER | MODULE EFFICIENCY | CORRELATED COLOUR TEMPERATURE | COLOUR RENDERING INDEX | TC LIFE | SALES PRICE |
|--------------|--------------|----------|---------|--------------|--------------|-------------------|-------------------------------|------------------------|---------|-------------|
| Δ see colors | | | | LM | W | LM/W | K | RA | HRS | EURO |
| 6120.112.24Δ | SLM 1100-830 | G4 | Philips | 1100 | 10 | 124 | 3000 | 82 | 50.000 | € 280,00 |
| 6120.113.24Δ | SLM 1100-840 | G4 | Philips | 1100 | 10 | 139 | 4000 | 82 | 50.000 | € 280,00 |
| 6120.111.24Δ | SLM 1100-927 | G4 | Philips | 1100 | 10 | 97 | 2700 | 97 | 50.000 | € 280,00 |
| 6120.131.24Δ | SLM 1100-930 | G4 | Philips | 1100 | 10 | 100 | 3000 | 97 | 50.000 | € 280,00 |
| 6120.132.24Δ | SLM 1100-940 | G4 | Philips | 1100 | 10 | 124 | 3000 | 82 | 50.000 | € 280,00 |
| 6120.114.24Δ | SLM 2000-830 | G4 | Philips | 2000 | 17 | 119 | 3000 | 82 | 50.000 | € 290,00 |
| 6120.116.24Δ | SLM 2000-840 | G4 | Philips | 2000 | 17 | 126 | 4000 | 82 | 50.000 | € 290,00 |
| 6120.125.24Δ | SLM 2000-927 | G4 | Philips | 2000 | 17 | 92 | 2700 | 97 | 50.000 | € 290,00 |
| 6120.120.24Δ | SLM 2000-930 | G4 | Philips | 2000 | 17 | 97 | 3000 | 97 | 50.000 | € 290,00 |
| 6120.144.24Δ | SLM 2000-940 | G4 | Philips | 2000 | 17 | 104 | 3000 | 82 | 50.000 | € 290,00 |
| 6120.117.24Δ | SLM 3000-830 | G4 | Philips | 3000 | 26 | 118 | 3000 | 82 | 50.000 | € 300,00 |
| 6120.119.24Δ | SLM 3000-840 | G4 | Philips | 3000 | 26 | 126 | 4000 | 82 | 50.000 | € 300,00 |
| 6120.128.24Δ | SLM 3000-927 | G4 | Philips | 3000 | 26 | 92 | 2700 | 97 | 50.000 | € 300,00 |
| 6120.121.24Δ | SLM 3000-930 | G4 | Philips | 3000 | 26 | 95 | 3000 | 97 | 50.000 | € 300,00 |
| 6120.145.24Δ | SLM 3000-940 | G4 | Philips | 3000 | 26 | 103 | 3000 | 82 | 50.000 | € 300,00 |

TECHNICAL INFORMATION

PRODUCT

VERO



- PRODUCT MATERIAL** ▶ Steel and aluminium
- LIGHT SOURCE** ▶ SLM G4
- MODULE LIFETIME** ▶ Approx. 50.000 hours
- LED COOLING** ▶ Passive cooling
- DRIVER** ▶ Incl. Xitanium driver.
- COLORS (Δ)** ▶
 - 3 = RAL 9003 white
 - 5 = RAL 9005 black
 - 6 = RAL 9006 alu
- BEAM ANGLE** ▶ 30°
- SIZE** ▶ 222 X 174MM

OPTIONS

- COLORS** ▶ Available in all RAL colours on request.
Additional price + 10%
- DIMMABLE** ▶ Dimmable or dali € 45,00

INFORMATION

- WARRANTY** ▶ 5 Years

Δ = product color code. See colors

Keylight International B.V. reserves the right to modify or change technical, construction or LED specifications due to continuous improvements of our products and lightsources.



VERO

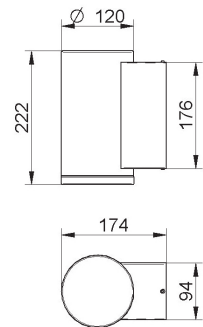

Technical drawing

| | TYPE | LED TYPE | BRAND | LIGHT OUTPUT | MODULE POWER | MODULE EFFICIENCY | CORRELATED COLOUR TEMPERATURE | COLOUR RENDERING INDEX | TC LIFE | SALES PRICE | |
|--------------|--------------|--------------|-------|--------------|--------------|-------------------|-------------------------------|------------------------|---------|-------------|----------|
| Δ see colors | | | | LM | W | LM/W | K | RA | HRS | EURO | |
| | 6012.112.24Δ | SLM 1100-830 | G4 | Philips | 1100 | 10 | 124 | 3000 | 82 | 50.000 | € 255,00 |
| | 6012.113.24Δ | SLM 1100-840 | G4 | Philips | 1100 | 10 | 139 | 4000 | 82 | 50.000 | € 255,00 |
| | 6012.111.24Δ | SLM 1100-927 | G4 | Philips | 1100 | 10 | 97 | 2700 | 97 | 50.000 | € 255,00 |
| | 6012.131.24Δ | SLM 1100-930 | G4 | Philips | 1100 | 10 | 100 | 3000 | 97 | 50.000 | € 255,00 |
| | 6012.132.24Δ | SLM 1100-940 | G4 | Philips | 1100 | 10 | 124 | 3000 | 82 | 50.000 | € 255,00 |
| | 6012.114.24Δ | SLM 2000-830 | G4 | Philips | 2000 | 17 | 119 | 3000 | 82 | 50.000 | € 260,00 |
| | 6012.116.24Δ | SLM 2000-840 | G4 | Philips | 2000 | 17 | 126 | 4000 | 82 | 50.000 | € 260,00 |
| | 6012.125.24Δ | SLM 2000-927 | G4 | Philips | 2000 | 17 | 92 | 2700 | 97 | 50.000 | € 260,00 |
| | 6012.120.24Δ | SLM 2000-930 | G4 | Philips | 2000 | 17 | 97 | 3000 | 97 | 50.000 | € 260,00 |
| | 6012.144.24Δ | SLM 2000-940 | G4 | Philips | 2000 | 17 | 104 | 3000 | 82 | 50.000 | € 260,00 |
| | 6012.117.24Δ | SLM 3000-830 | G4 | Philips | 3000 | 26 | 118 | 3000 | 82 | 50.000 | € 270,00 |
| | 6012.119.24Δ | SLM 3000-840 | G4 | Philips | 3000 | 26 | 126 | 4000 | 82 | 50.000 | € 270,00 |
| | 6012.128.24Δ | SLM 3000-927 | G4 | Philips | 3000 | 26 | 92 | 2700 | 97 | 50.000 | € 270,00 |
| | 6012.121.24Δ | SLM 3000-930 | G4 | Philips | 3000 | 26 | 95 | 3000 | 97 | 50.000 | € 270,00 |
| | 6012.145.24Δ | SLM 3000-940 | G4 | Philips | 3000 | 26 | 103 | 3000 | 82 | 50.000 | € 270,00 |

A close-up photograph of a white LED strip light. The strip is curved, and several small, glowing yellow LEDs are visible. A white plastic connector is attached to the end of the strip. The background is dark, making the light stand out.

Stripes & Ledlines



| ARTICLE NO. | DESCRIPTION | VOLTAGE | WATTAGE | CORRELATED COLOUR TEMPERATURE | LUMEN PER 5M | LENGTH | WIDTH | SALES PRICE |
|---------------------|-------------------------------|---------|---------|-------------------------------|--------------|--------|-------|-------------|
| Stripe Basic | | V | W | K | LM | M | MM | EURO |
| 0203.999.99.0 | Stripe basic 150 LED's | 24 | 36 | ± 3000 | 1800 | 5 | 10 | € 99,00 |
| 0204.999.99.0 | Stripe basic 150 LED's | 24 | 36 | ± 6000 | 1800 | 5 | 10 | € 99,00 |
| 0205.999.99.0 | Stripe basic 150 LED's | 24 | 36 | RGB | | 5 | 10 | € 99,00 |
| 0206.999.99.0 | Stripe basic 300 LED's | 24 | 72 | ± 3000 | 3600 | 5 | 10 | € 170,00 |
| 0207.999.99.0 | Stripe basic 300 LED's | 24 | 72 | ± 6000 | 3600 | 5 | 10 | € 170,00 |
| 0208.999.99.0 | Stripe basic 300 LED's | 24 | 72 | RGB | | 5 | 10 | € 170,00 |

| ARTICLE NO. | DESCRIPTION | VOLTAGE | WATTAGE | CORRELATED COLOUR TEMPERATURE | LUMEN PER 5M | LENGTH | WIDTH | SALES PRICE |
|-------------------|-----------------------------|---------|---------|-------------------------------|--------------|--------|-------|-------------|
| Stripe ECO | | V | W | K | LM | M | MM | EURO |
| 0220.999.99.0 | Stripe ECO 150 LED's | 24 | 36 | ± 2800 | 2700 | 5 | 10 | € 175,00 |
| 0221.999.99.0 | Stripe ECO 150 LED's | 24 | 36 | ± 3000 | 2700 | 5 | 10 | € 175,00 |
| 0222.999.99.0 | Stripe ECO 150 LED's | 24 | 36 | ± 4500 | 2700 | 5 | 10 | € 175,00 |
| 0223.999.99.0 | Stripe ECO 300 LED's | 24 | 36 | ± 2800 | 2700 | 5 | 10 | € 210,00 |
| 0224.999.99.0 | Stripe ECO 300 LED's | 24 | 36 | RGB | 600 | 5 | 10 | € 175,00 |
| 0225.999.99.0 | Stripe ECO 300 LED's | 24 | 36 | RGB | 600 | 5 | 10 | € 205,00 |

| ARTICLE NO. | DESCRIPTION | VOLTAGE | WATTAGE | CORRELATED COLOUR TEMPERATURE | LUMEN PER 5M | LENGTH | WIDTH | SALES PRICE |
|-------------------|-------------------------------------|---------|---------|-------------------------------|--------------|--------|-------|-------------|
| Stripe 300 | | V | W | K | LM | M | MM | EURO |
| 0301.999.99.0 | Stripe 300 LED's | 24 | 72 | ± 2800 | 5400 | 5 | 12 | € 290,00 |
| 0302.999.99.0 | Stripe 300 LED's | 24 | 72 | ± 3000 | 5400 | 5 | 12 | € 290,00 |
| 0303.999.99.0 | Stripe 300 LED's | 24 | 72 | ± 4500 | 5400 | 5 | 12 | € 290,00 |
| 0304.999.99.0 | Stripe 300 LED's IP68 | 24 | 72 | ± 2800 | 5400 | 5 | 12 | € 315,00 |
| 0305.999.99.0 | Stripe 300 LED's IP68 | 24 | 72 | ± 3000 | 5400 | 5 | 12 | € 315,00 |
| 0306.999.99.0 | Stripe 300 LED's | 24 | 72 | RGB | 1200 | 5 | 12 | € 280,00 |
| 0307.999.99.0 | Stripe 300 LED's IP68 | 24 | 72 | RGB | 1200 | 5 | 12 | € 315,00 |

| ARTICLE NO. | DESCRIPTION | VOLTAGE | WATTAGE | CORRELATED COLOUR TEMPERATURE | LUMEN PER 5M | LENGTH | WIDTH | SALES PRICE |
|-------------------|--|---------|---------|-------------------------------|--------------|--------|-------|-------------|
| Stripe 600 | | V | W | K | LM | M | MM | EURO |
| 0201.999.99.0 | Stripe 600 LED's Color mix | 24 | 48 | ± 25/2800 | 3600 | 5 | 10 | € 275,00 |
| 0202.999.99.0 | Stripe 600 LED's Color mix | 24 | 48 | ± 28/3500 | 3600 | 5 | 10 | € 275,00 |

Cutting sizes 36w STRIPE 16,50 cm - 72w BASIC + ECO 10 cm.

For full warranty of 3 years, use the Keylight LED'S drivers! - Full warranty (Stripe BASIC) 1 year, always use the Keylight LED'S drivers!

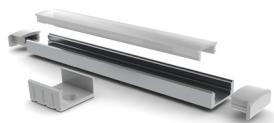

| ARTICLE NO. | DESCRIPTION | PROFILE | COVER | INNER WIDTH | SIZE | SALES PRICE |
|------------------|-------------|--------------------|--------------|-------------|-----------------|-------------|
| LEDLINE 7 | | | | MM | MM | EURO |
| 0607.999.91.6 | LEDLINE 7mm | Aluminium anodized | Clear | 12.2 | 2000 X 17.5 X 7 | € 39,50 |
| 0607.999.90.6 | LEDLINE 7mm | Aluminium anodized | 100% Frosted | 12.2 | 2000 X 17.5 X 7 | € 39,50 |

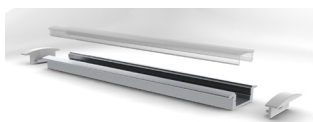

| ARTICLE NO. | DESCRIPTION | PROFILE | COVER | INNER WIDTH | SIZE | SALES PRICE |
|-------------------|---------------|--------------------|--------------|-------------|-----------------|-------------|
| LEDLINE 7R | | | | MM | MM | EURO |
| 0677.999.91.6 | LEDLINE R 7mm | Aluminium anodized | Clear | 12.2 | 2000 X 24.5 X 7 | € 39,50 |
| 0677.999.90.6 | LEDLINE R 7mm | Aluminium anodized | 100% Frosted | 12.2 | 2000 X 24.5 X 7 | € 39,50 |

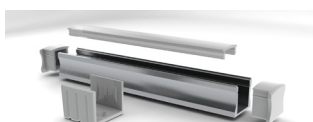

| ARTICLE NO. | DESCRIPTION | PROFILE | COVER | INNER WIDTH | SIZE | SALES PRICE |
|-------------------|--------------|--------------------|--------------|-------------|------------------|-------------|
| LEDLINE 15 | | | | MM | MM | EURO |
| 0615.999.91.6 | LEDLINE 15mm | Aluminium anodized | Clear | 12.2 | 2000 X 17.5 X 15 | € 39,50 |
| 0615.999.90.6 | LEDLINE 15mm | Aluminium anodized | 100% Frosted | 12.2 | 2000 X 17.5 X 15 | € 39,50 |

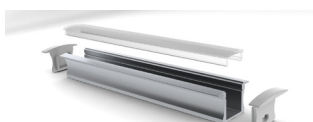

| ARTICLE NO. | DESCRIPTION | PROFILE | COVER | INNER WIDTH | SIZE | SALES PRICE |
|--------------------|----------------|--------------------|--------------|-------------|------------------|-------------|
| LEDLINE 15R | | | | MM | MM | EURO |
| 0651.999.91.6 | LEDLINE R 15mm | Aluminium anodized | Clear | 12.2 | 2000 X 24.5 X 15 | € 39,50 |
| 0651.999.90.6 | LEDLINE R 15mm | Aluminium anodized | 100% Frosted | 12.2 | 2000 X 24.5 X 15 | € 39,50 |



| ARTICLE NO. | DESCRIPTION | PROFILE | COVER | INNER WIDTH | SIZE | SALES PRICE |
|--------------------|-------------|--------------------|--------------|-------------|--------------------|-------------|
| LEDLINE 45C | | | | MM | MM | EURO |
| 0618.999.91.6 | LEDLINE 45° | Aluminium anodized | Clear | 12.2 | 2000 X 18.5 X 18,5 | € 69,00 |
| 0618.999.90.6 | LEDLINE 45° | Aluminium anodized | 100% Frosted | 12.2 | 2000 X 18.5 X 18,5 | € 69,00 |

Accessoires

| | | | | | | | | | |
|--------------------|---------------|-----------------------|--------|---------------|---------------------|--------|---------------|-------------------|--------|
| LEDLINE 7 | 0707.999.99.6 | Endcap with cablehole | € 3,50 | 0770.999.99.6 | Encap w/o cablehole | € 3,50 | 0777.999.99.6 | Mounting brackets | € 3,50 |
| LEDLINE 7R | 0701.999.99.6 | Endcap with cablehole | € 3,50 | 0702.999.99.6 | Encap w/o cablehole | € 3,50 | | | |
| LEDLINE 15 | 0765.999.99.6 | Endcap with cablehole | € 3,50 | 0756.999.99.6 | Encap w/o cablehole | € 3,50 | 0750.999.99.6 | Mounting brackets | € 3,50 |
| LEDLINE 15R | 0715.999.99.6 | Endcap with cablehole | € 3,50 | 0751.999.99.6 | Encap w/o cablehole | € 3,50 | | | |
| LEDLINE 45C | 0745.999.99.6 | Endcap with cablehole | € 4,25 | 0754.999.99.6 | Encap w/o cablehole | € 4,25 | 0746.999.99.6 | Mounting brackets | € 3,50 |

The profile with choice of frosted diffuser is "LEDs DOTS FREE" and deliver soft smooth light on the whole surface.

The profile can accommodate standard led stripes up to 12mm of the wideness. It is quality and contemporary design which fits in many places.

Ledline is made from anodized aluminum with choice of high quality frosted ("LEDs DOTS FREE"), 50% frosted or transparent snap-in diffuser and matching end caps.

The snap-in diffuser is made from UV resistant material and it is damage resistant (walk over safe).

The aluminum profile is performing as the heat sink to the LEDs and also presents itself as nice, stylish housing where all components are matching and are high quality

Technical drawings whit measurements and mounting instructions are available on request.

Notice - Legible Viewing Distance 50 feet



Emergency Luminaires



ESCAPE EXIT
PAGE 1



ESCAPE SQUARE
PAGE 1



ESCAPE ROUND
PAGE 1



EXCAPE R MINI
PAGE 1

Emergency Luminaires

| | |
|-----------|--------|
| UTAH 18 | PAGE 1 |
| YORK | PAGE 1 |
| DL 180 | PAGE 1 |
| KANSAS 16 | PAGE 1 |

TECHNICAL INFORMATION



PRODUCT

ESCAPE EXIT



- PRODUCT MATERIAL** ▶ Aluminium
- PANEL** ▶ Acrylic board with imprinted dot-matrix lens diffusion.
- LIGHTSOURCE** ▶ SMD 3528 - 14PCS
- LED COOLING** ▶ Passive cooling
- COLORS (Δ)** ▶ ● 3 = RAL 9003 white
- VIEWING ANGLE** ▶ 30M
- SIZE** ▶ 330 X 251 X 15MM

INFORMATION

- MOUNTING OPTIONS** ▶ Wall surface
Ceiling
Side
- PICTOGRAMS (INCL.)** ▶  1x Blanc
 2x arrow down
 2x arrow left/right
- EMERGENCY BATTERY** ▶ Including sealed nickel-cadmium rechargeable battery pack (1Hr.)
- AUTO MAINTENANCE** ▶ Once the unit is powered up it will automatically initiate a self test and diagnostics. Detailed specifications on request.
- E N STANDARD** ▶ On request

Keylight International B.V. reserves the right to modify or change technical, construction or LED specifications due to continuous improvements of our products and lightsources.



ESCAPE EXIT

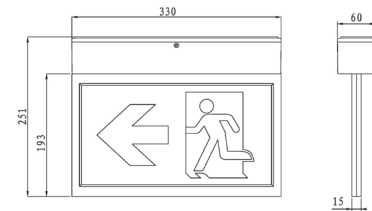

Technical drawing

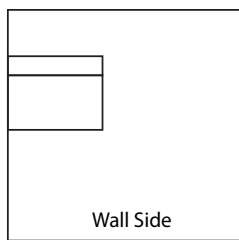
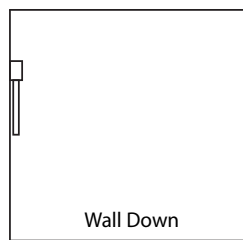
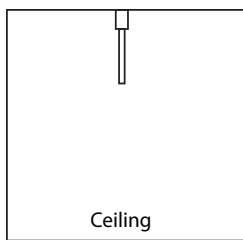

Symbolen tekenen mounting possibilities

| ARTICLE NO. | LAMP TYPE | LIGHT OUTPUT | EMERGENCY LUMEN OUTPUT | MODULE POWER | BATTERY CHARGE DURATION | BATTERY LIFETIME WHEN DISCONNECTED | BATTERY | VIEWING DISTANCE | SALES PRICE |
|---------------|--------------|--------------|------------------------|--------------|-------------------------|------------------------------------|------------------|------------------|-------------|
| | | LM | LM | W | HRS | HRS | | | EURO |
| 0551.999.50.3 | SMD LED 3528 | 50 | 8.86 | 4 | 24 | 1 | Ni_Cd 3.6v 800mA | 30M | € 145,00 |

TECHNICAL INFORMATION

PRODUCT

ESCAPE SQUARE



- PRODUCT MATERIAL** ▶ Thermoplastic housing
- LIGHTSOURCE** ▶ LED
- LED COOLING** ▶ Passive cooling
- COLORS (Δ)** ▶ ● 3 = RAL 9003 white
- VIEWING ANGLE** ▶ Escape route
- SIZE** ▶ 140 X 125 X 38MM

INFORMATION

- COLOUR TEMP.** ▶ 6000K
- MOUNTING OPTIONS** ▶ Wall / surface
- MAINTENANT** ▶ Non-maintenant
- AUTO TEST** ▶ Yes
- EMERGENCY BATTERY** ▶ Including sealed nickel-cadmium rechargeable battery pack (1Hr.)
- E N STANDARD** ▶ On request



ESCAPE SQUARE

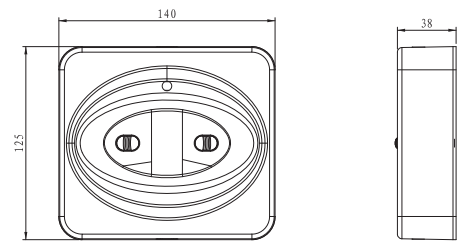

Technical drawing

Keylight International B.V. reserves the right to modify or change technical, construction or LED specifications due to continuous improvements of our products and lightsources.

| ARTICLE NO. | LAMP TYPE | LIGHT OUTPUT | EMERGENCY LUMEN OUTPUT | MODULE POWER | BATTERY CHARGE DURATION | BATTERY LIFETIME WHEN DISCONNECTED | BATTERY | VIEWING DISTANCE | SALES PRICE |
|---------------|-----------|--------------|------------------------|--------------|-------------------------|------------------------------------|------------------|------------------|-------------|
| | | LM | LM | W | HRS | HRS | | | EURO |
| 0554.999.18.3 | LED | 180 | 1Hrs / 180LM | 2 X 3W | 24 | 1 | Ni_Cd 7.2v 800mA | Escape Route | € 125,00 |

TECHNICAL INFORMATION

PRODUCT

ESCAPE DOWN R



- PRODUCT MATERIAL** ▶ Thermoplastic housing
- LIGHTSOURCE** ▶ LED
- LED COOLING** ▶ Passive cooling
- COLORS (Δ)** ▶ ● 3 = RAL 9003 white
- VIEWING ANGLE** ▶ Escape route
- SIZE** ▶ 125 X 62MM

INFORMATION

- COLOUR TEMP.** ▶ 6000K
- MOUNTING OPTIONS** ▶ Recessed round
- MAINTENANT** ▶ Non-maintenant
- AUTO TEST** ▶ Yes
- EMERGENCY BATTERY** ▶ Including sealed nickel-cadmium rechargeable battery pack (1Hr.)
- E N STANDARD** ▶ On request



ESCAPE DOWN R

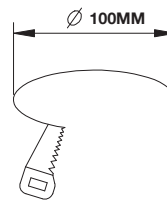

Hole size

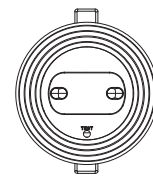

Technical drawing

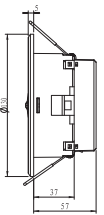

Keylight International B.V. reserves the right to modify or change technical, construction or LED specifications due to continuous improvements of our products and lightsources.

| ARTICLE NO. | LAMP TYPE | LIGHT OUTPUT | EMERGENCY LUMEN OUTPUT | MODULE POWER | BATTERY CHARGE DURATION | BATTERY LIFETIME WHEN DISCONNECTED | BATTERY | VIEWING DISTANCE | SALES PRICE |
|---------------|-----------|--------------|------------------------|--------------|-------------------------|------------------------------------|------------------|------------------|-------------|
| | | LM | LM | W | HRS | HRS | | | EURO |
| 0552.999.18.3 | LED | 180 | 1Hrs / 180LM | 2 X 3W | 24 | 1 | Ni_Cd 7.2v 800mA | Escape Route | € 125,00 |

TECHNICAL INFORMATION

PRODUCT

ESCAPE R MINI



- PRODUCT MATERIAL** ▶ Aluminium
- LIGHTSOURCE** ▶ Cree XT-E
- LED COOLING** ▶ Passive cooling
- COLOR** ▶ ● 3 = RAL 9003 white
- VIEWING ANGLE** ▶ Escape Route
- SIZE** ▶ 55MM / 2x 196 x 133mm
- CUT OUT SIZE** ▶ 40MM

INFORMATION

- COLOUR TEMP.** ▶ 6000K
- MOUNTING OPTIONS** ▶ Recessed round
- MAINTENANT** ▶ Non-maintenant
- AUTO TEST** ▶ Yes, autotesting operation on request
- EMERGENCY BATTERY** ▶ Including sealed nickel-cadmium rechargeable battery pack (1Hr.)
- DALI** ▶ Suitable for DALI
- E N STANDARD** ▶ On request



ESCAPE MINI DOWN

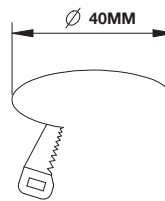

Hole size

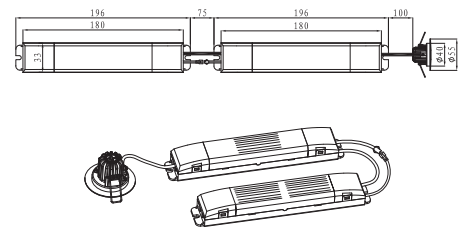

Technical drawing

Keylight International B.V. reserves the right to modify or change technical, construction or LED specifications due to continuous improvements of our products and lightsources.

| ARTICLE NO. | LAMP TYPE | LIGHT OUTPUT | EMERGENCY LUMEN OUTPUT | MODULE POWER | BATTERY CHARGE DURATION | BATTERY LIFETIME WHEN DISCONNECTED | BATTERY | VIEWING DISTANCE | SALES PRICE |
|---------------|-----------|--------------|------------------------|--------------|-------------------------|------------------------------------|------------------|------------------|-------------|
| | | LM | LM | W | HRS | HRS | | | EURO |
| 0553.999.15.3 | Cree XT-E | 150 | 1Hrs / 180LM | 5W | 24 | 1 | Ni_Cd 3.6v 800mA | Escape Route | € 95,00 |



Exterior
Recessed & Surface



LINKON 14
PAGE 1



DENVER 20
PAGE 1



DENVER 23
PAGE 1



UDO 19 SF
PAGE 1



PROFILE 8
PAGE 1



STATION
PAGE 1



BIG STEEL
PAGE 1



AQUA LED
PAGE 1

Exterior Recessed & Surface

| | |
|-----------|--------|
| BIG STEEL | PAGE 1 |
| DENVER 20 | PAGE 1 |
| DENVER 23 | PAGE 1 |
| HIGHLIGHT | PAGE 1 |
| LINKON 14 | PAGE 1 |
| VISION 15 | PAGE 1 |
| VISION 20 | PAGE 1 |
| ROLED | PAGE 1 |
| CAP R1 | PAGE 1 |
| CAP R2 | PAGE 1 |

TECHNICAL INFORMATION

PRODUCT

LINKON 14



- PRODUCT MATERIAL** ▶ Aluminium
- LIGHT SOURCE** ▶ SLM G4
- MODULE LIFETIME** ▶ Approx. 50.000 hours
- LED COOLING** ▶ Fan cooling
- DRIVER** ▶ Incl. Xitanium driver.
- COLORS (Δ)** ▶
 - 3 = RAL 9003 white
 - 5 = RAL 9005 black
 - 6 = RAL 9006 alu
- BEAM ANGLE** ▶ 60°
- ADJUSTABLE** ▶ No
- SIZE** ▶ 140 X 140MM

OPTIONS

- COLORS** ▶ Available in all RAL colours on request.
Additional price + 10%
- EMERGENCY BALLAST** ▶ 0187.999.99 1 - 3 hours. € 225,00
- DIMMABLE** ▶ Dimmable or dali € 45,00

INFORMATION

- WARRANTY** ▶ 5 Years

Δ = product color code. See colors

Keylight International B.V. reserves the right to modify or change technical, construction or LED specifications due to continuous improvements of our products and lightsources.



LINKON 14

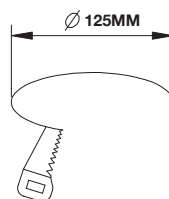

Hole size

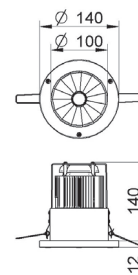

Technical drawing

| ARTICLE NO. | LAMP TYPE | BRAND | LIGHT OUTPUT | MODULE POWER | SETTING * | MODULE EFFICIENCY | CORRELATED COLOUR TEMPERATURE | COLOUR RENDERING INDEX | B50/L70 AT TC LIFE | SALES PRICE |
|---------------|--------------------|---------|--------------|--------------|-----------------|-------------------|-------------------------------|------------------------|--------------------|-------------|
| Δ see colors | GEN 4 | | LM | W | | LM/W | K | RA | HRS | EURO |
| 8014.111.60.Δ | SLM 1100-827 L13 # | Philips | 1160 | 10 | High Efficiency | 114 | 2700 | >82 | 50.000 | € 295,00 |
| 8014.112.60.Δ | SLM 1100-830 L13 | Philips | 1240 | 10 | High Efficiency | 122 | 3000 | >82 | 50.000 | € 295,00 |
| 8014.113.60.Δ | SLM 1100-840 L13 | Philips | 1330 | 10 | High Efficiency | 130 | 4000 | >82 | 50.000 | € 295,00 |
| 8014.114.60.Δ | SLM 2000-830 L13 | Philips | 2020 | 17 | High Efficiency | 117 | 3000 | >82 | 50.000 | € 305,00 |
| 8014.116.60.Δ | SLM 2000-840 L13 | Philips | 2150 | 17 | High Efficiency | 124 | 4000 | >82 | 50.000 | € 305,00 |
| 8014.125.60.Δ | SLM 2000-927 L13 # | Philips | 1570 | 17 | High Efficiency | 91 | 2700 | >97 | 50.000 | € 305,00 |
| 8014.120.60.Δ | SLM 2000-930 L13 | Philips | 1650 | 17 | High Efficiency | 95 | 3000 | >97 | 50.000 | € 305,00 |
| 8014.117.60.Δ | SLM 3000-830 L15 | Philips | 2970 | 26 | High Efficiency | 114 | 3000 | >82 | 50.000 | € 310,00 |
| 8014.119.60.Δ | SLM 3000-840 L15 | Philips | 3170 | 26 | High Efficiency | 122 | 4000 | >82 | 50.000 | € 310,00 |
| 8014.128.60.Δ | SLM 3000-927 L15 # | Philips | 2320 | 26 | High Efficiency | 89 | 2700 | >97 | 50.000 | € 310,00 |
| 8014.121.60.Δ | SLM 3000-930 L15 | Philips | 2400 | 26 | High Efficiency | 92 | 3000 | >97 | 50.000 | € 310,00 |
| 8014.135.60.Δ | SLM 4500-830 L19 | Philips | 4860 | 42 | High Efficiency | 114 | 3000 | >82 | 50.000 | € 320,00 |
| 8014.136.60.Δ | SLM 4500-840 L19 | Philips | 5160 | 42 | High Efficiency | 122 | 4000 | >82 | 50.000 | € 320,00 |
| 8014.157.60.Δ | SLM 4500-927 L19 | Philips | 3760 | 42 | High Efficiency | 89 | 2700 | >97 | 50.000 | € 320,00 |
| 8014.137.60.Δ | SLM 4500-930 L19 | Philips | 3930 | 42 | High Efficiency | 92 | 3000 | >97 | 50.000 | € 320,00 |

TECHNICAL INFORMATION

PRODUCT

DENVER 20



- PRODUCT MATERIAL** ▶ Aluminium
- LIGHT SOURCE** ▶ DLM G5
- MODULE LIFETIME** ▶ DLM Approx. 50.000 hours
- LED COOLING** ▶ Passive cooling
- DRIVER DLM** ▶ Incl. standard xitanium driver.
- COLORS** ▶
 - 3 = RAL 9003 white
 - 5 = RAL 9005 black
 - 6 = RAL 9006 alu
- BEAM ANGLE** ▶ 80°
- ADJUSTABLE** ▶ No
- SIZE** ▶ 196 X 190MM

OPTIONS

- COLORS** ▶ Available in all RAL colours on request
Additional price + 10%
- EMERGENCY BALLAST** ▶ DLM: 0187.999.99 1 - 3 hours € 215,00
- DIMMABLE** ▶ DLM: Dimmable or dali € 45,00

INFORMATION

- WARRANTY** ▶ 5 Years

Δ see colors



DENVER 20

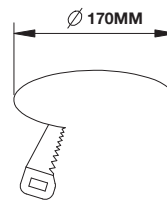

Hole size

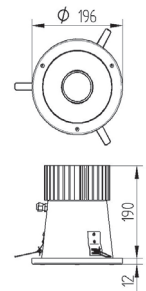

Technical drawing

Keylight International B.V. reserves the right to modify or change technical, construction or LED specifications due to continuous improvements of our products and lightsources.

| ARTICLE NO. | LAMP TYPE | BRAND | LIGHT OUTPUT | MODULE POWER | MODULE EFFICIENCY | CORRELATED COLOUR TEMPERATURE | COLOUR RENDERING INDEX | TC LIFE | POWER FACTOR | SALES PRICE |
|--------------|-----------|---------|--------------|--------------|-------------------|-------------------------------|------------------------|---------|--------------|-------------|
| Δ see colors | | | LM | W | LM/W | K | RA | HRS | PF | EURO |
| 8196.124.60Δ | DLM-Int | Philips | 1100 | 15 | 73 | 3000 | >80 | 25.000 | >,09 | € 290,00 |
| 8196.123.60Δ | DLM-Int | Philips | 1100 | 14 | 79 | 4000 | >80 | 25.000 | >,09 | € 290,00 |
| 8196.124.60Δ | DLM-Int | Philips | 2000 | 28 | 71 | 3000 | >80 | 25.000 | >,09 | € 295,00 |
| 8196.125.60Δ | DLM-Int | Philips | 2000 | 27 | 74 | 4000 | >80 | 25.000 | >,09 | € 295,00 |
| 8196.101.60Δ | DLM G5 | Philips | 1100 | 11 | 100 | 3000 | >80 | 50.000 | >,09 | € 325,00 |
| 8196.102.60Δ | DLM G5 | Philips | 1100 | 10 | 110 | 4000 | >80 | 50.000 | >,09 | € 325,00 |
| 8196.103.60Δ | DLM G5 | Philips | 2000 | 21 | 95 | 3000 | >80 | 50.000 | >,09 | € 340,00 |
| 8196.104.60Δ | DLM G5 | Philips | 2000 | 19 | 105 | 3000 | >80 | 50.000 | >,09 | € 340,00 |
| 8196.105.60Δ | DLM G5 | Philips | 3000 | 32 | 94 | 3000 | >80 | 50.000 | >,09 | € 350,00 |
| 8196.106.60Δ | DLM G5 | Philips | 3000 | 29 | 103 | 4000 | >80 | 50.000 | >,09 | € 350,00 |

TECHNICAL INFORMATION

PRODUCT

DENVER 23



- PRODUCT MATERIAL** ▶ Steel and Alu
- LIGHT SOURCE** ▶ DLM G5
- MODULE LIFETIME** ▶ DLM Approx. 50.000 hours
- LED COOLING** ▶ Passive cooling
- DRIVER DLM** ▶ Incl. standard xitanium driver.
- COLORS** ▶
 - 3 = RAL 9003 white
 - 5 = RAL 9005 black
 - 6 = RAL 9006 alu
- BEAM ANGLE** ▶ 80°
- ADJUSTABLE** ▶ No
- SIZE** ▶ 230 X 288MM

OPTIONS

- COLORS** ▶ Available in all RAL colours on request
Additional price + 10%
- EMERGENCY BALLAST** ▶ DLM: 0187.999.99 1 - 3 hours € 225,00
- DIMMABLE** ▶ DLM: Dimmable or dali € 45,00

INFORMATION

- WARRANTY** ▶ 5 Years
- Δ see colors

Keylight International B.V. reserves the right to modify or change technical, construction or LED specifications due to continuous improvements of our products and lightsources.



DENVER 23

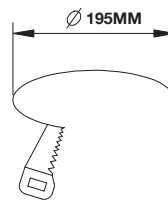

Hole size

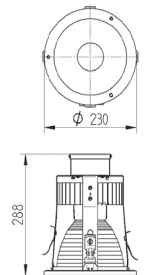

Technical drawing

| ARTICLE NO. | LAMP TYPE | BRAND | LIGHT OUTPUT | MODULE POWER | MODULE EFFICIENCY | CORRELATED COLOUR TEMPERATURE | COLOUR RENDERING INDEX | TC LIFE | POWER FACTOR | SALES PRICE |
|--------------|-----------|---------|--------------|--------------|-------------------|-------------------------------|------------------------|---------|--------------|-------------|
| Δ see colors | | | LM | W | LM/W | K | RA | HRS | PF | EURO |
| 8230.124.60Δ | DLM-Int | Philips | 1100 | 15 | 73 | 3000 | >80 | 25.000 | >,09 | € 330,00 |
| 8230.123.60Δ | DLM-Int | Philips | 1100 | 14 | 79 | 4000 | >80 | 25.000 | >,09 | € 330,00 |
| 8230.124.60Δ | DLM-Int | Philips | 2000 | 28 | 71 | 3000 | >80 | 25.000 | >,09 | € 335,00 |
| 8230.125.60Δ | DLM-Int | Philips | 2000 | 27 | 74 | 4000 | >80 | 25.000 | >,09 | € 335,00 |
| 8230.101.60Δ | DLM G5 | Philips | 1100 | 11 | 100 | 3000 | >80 | 50.000 | >,09 | € 360,00 |
| 8230.102.60Δ | DLM G5 | Philips | 1100 | 10 | 110 | 4000 | >80 | 50.000 | >,09 | € 360,00 |
| 8230.103.60Δ | DLM G5 | Philips | 2000 | 21 | 95 | 3000 | >80 | 50.000 | >,09 | € 370,00 |
| 8230.104.60Δ | DLM G5 | Philips | 2000 | 19 | 105 | 3000 | >80 | 50.000 | >,09 | € 370,00 |
| 8230.105.60Δ | DLM G5 | Philips | 3000 | 32 | 94 | 3000 | >80 | 50.000 | >,09 | € 380,00 |
| 8230.106.60Δ | DLM G5 | Philips | 3000 | 29 | 103 | 4000 | >80 | 50.000 | >,09 | € 380,00 |

STAT

4,4 max. 4,4



TECHNICAL INFORMATION

PRODUCT

UDO 19 SF



- PRODUCT MATERIAL** ▶ Aluminium
- LIGHT SOURCE** ▶ Masterled
- MODULE LIFETIME** ▶ Approx. 40.000 hours
- LED COOLING** ▶ Passive cooling
- COLORS (Δ)** ▶
 - 3 = RAL 9003 white
 - 5 = RAL 9005 black
 - 6 = RAL 9006 alu
- BEAM ANGLE** ▶ 25° / 40°
- SIZE** ▶ 100 X 182MM

OPTIONS

- COLORS** ▶ Available in all RAL colours on request.
Additional price + 10%

INFORMATION

- WARRANTY** ▶ 5 Years

Δ = product color code. See colors

Without lightsource

Keylight International B.V. reserves the right to modify or change technical, construction or LED specifications due to continuous improvements of our products and lightsources.



UDO 19 SF

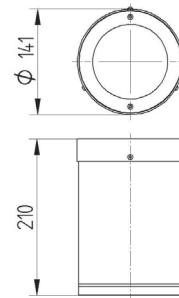

Technical drawing

| ARTICLE NO. | LAMP TYPE | BRAND | LIGHT OUTPUT | MODULE POWER | MODULE EFFICIENCY | CORRELATED COLOUR TEMPERATURE | COLOUR RENDERING INDEX | TC LIFE | SALES PRICE |
|--------------|-----------|---------|--------------|--------------|-------------------|-------------------------------|------------------------|---------|-------------|
| Δ see colors | | | LM | W | LM/W | K | RA | HRS | EURO |
| 8141.601.99Δ | Masterled | Philips | 860 | 2 X 8 | 54 | 2700 | >80 | 40.000 | € 175,00 |
| 8141.602.99Δ | Masterled | Philips | 860 | 2 X 8 | 54 | 2700 | >80 | 40.000 | € 175,00 |
| 8141.603.99Δ | Masterled | Philips | 900 | 2 X 8 | 56 | 3000 | >80 | 40.000 | € 175,00 |
| 8141.604.99Δ | Masterled | Philips | 900 | 2 X 8 | 56 | 3000 | >80 | 40.000 | € 175,00 |
| 8141.605.99Δ | Masterled | Philips | 900 | 2 X 8 | 56 | 4000 | >80 | 40.000 | € 175,00 |
| 8141.606.99Δ | Masterled | Philips | 900 | 2 X 8 | 56 | 4000 | >80 | 40.000 | € 175,00 |

TECHNICAL INFORMATION

PRODUCT

PROFILE 8



- PRODUCT MATERIAL** ▶ Aluminium
- LIGHT SOURCE** ▶ Philips LEDLine
- MODULE LIFETIME** ▶ Approx. 50.000 hours
- LED COOLING** ▶ Passive cooling
- DRIVER LEDLINE** ▶ Incl. standard xitanium driver.
- COLORS (Δ)** ▶
 - 3 = RAL 9003 white
 - 5 = RAL 9005 black
 - 6 = RAL 9006 alu
- REFLECTOR PLATE** ▶ Clear or matte acrylic plate
- ADJUSTABLE** ▶ No
- SIZE** ▶ **1200/1500 X 120 X 68MM**

OPTIONS

- COLORS** ▶ Available in all RAL colours on request
Additional price + 10%
- DIMMABLE** ▶ Dimmable DALI € 45,00
- SAFETY GLASS** ▶ On request

INFORMATION

- WARRANTY** ▶ 5 Years

Keylight International B.V. reserves the right to modify or change technical, construction or LED specifications due to continuous improvements of our products and lightsources.



PROFILE 8

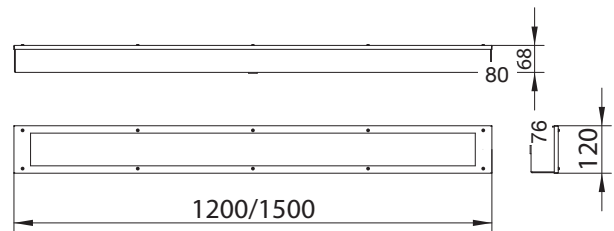

Technical drawing

| ARTICLE NO. | LAMP TYPE | BRAND | LIGHT OUTPUT | MODULE POWER | MODULE EFFICIENCY | CORRELATED COLOUR TEMPERATURE | COLOUR RENDERING INDEX | TC LIFE | LENGTH | SALES PRICE |
|--------------|-----------|---------|--------------|--------------|-------------------|-------------------------------|------------------------|---------|--------|-------------|
| Δ see colors | | | LM | W | LM/W | K | RA | HRS | MM | EURO |
| 4035.291.83Δ | LEDLine | Philips | 4400 | 33 | 133 | 3000 | >80 | 50.000 | 1200 | € 440,00 |
| 4035.291.84Δ | LEDLine | Philips | 4400 | 33 | 133 | 4000 | >80 | 50.000 | 1200 | € 440,00 |
| 4035.292.83Δ | LEDLine | Philips | 5500 | 41 | 134 | 3000 | >80 | 50.000 | 1500 | € 495,00 |
| 4035.292.84Δ | LEDLine | Philips | 5500 | 41 | 134 | 4000 | >80 | 50.000 | 1500 | € 495,00 |



TECHNICAL INFORMATION

PRODUCT

STATION



- PRODUCT MATERIAL** ▶ Aluminium
- LIGHT SOURCE** ▶ Osram LEDPlate
- MODULE LIFETIME** ▶ Approx. 50.000 hours
- LED COOLING** ▶ Passive cooling
- DRIVER** ▶ Incl. standard Osram driver.
- COLORS (Δ)** ▶
 - 3 = RAL 9003 white
 - 5 = RAL 9005 black
 - 6 = RAL 9006 alu
- REFLECTOR PLATE** ▶ Clear Glass
- ADJUSTABLE** ▶ No
- SIZE** ▶ 595 X 296 X 100MM

OPTIONS

- COLORS** ▶ Available in all RAL colours on request
Additional price + 10%
- DIMMABLE** ▶ Dimmable or dali € 45,00
- 2 LIGHT VERSION** ▶ Also available in 2 light version. € 650,00

INFORMATION

- WARRANTY** ▶ 5 Years

Δ see colors

Keylight International B.V. reserves the right to modify or change technical, construction or LED specifications due to continuous improvements of our products and lightsources.



STATION

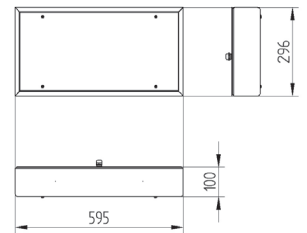

Technical drawing

| ARTICLE NO. | LAMP TYPE | BRAND | LIGHT OUTPUT | MODULE POWER | MODULE EFFICIENCY | CORRELATED COLOUR TEMPERATURE | COLOUR RENDERING INDEX | TC LIFE | SALES PRICE |
|--------------|-----------|-------|--------------|--------------|-------------------|-------------------------------|------------------------|---------|-------------|
| Δ see colors | | | LM | W | LM/W | K | RA | HRS | EURO |
| 4032.181.91Δ | LEDPlate | Osram | 1400 | 16 | 84 | 3000 | >80 | 50.000 | € 475,00 |
| 4032.182.91Δ | LEDPlate | Osram | 2000 | 23 | 83 | 3000 | >80 | 50.000 | € 475,00 |
| 4032.183.91Δ | LEDPlate | Osram | 2600 | 33 | 76 | 3000 | >80 | 50.000 | € 475,00 |
| 4032.184.91Δ | LEDPlate | Osram | 1400 | 16 | 87 | 4000 | >80 | 50.000 | € 475,00 |
| 4032.185.91Δ | LEDPlate | Osram | 2000 | 23 | 87 | 4000 | >80 | 50.000 | € 475,00 |
| 4032.186.91Δ | LEDPlate | Osram | 2600 | 33 | 79 | 4000 | >80 | 50.000 | € 475,00 |

TECHNICAL INFORMATION

PRODUCT

BIG STEEL



- PRODUCT MATERIAL** ▶ Stainless steel & Aluminium
- LIGHT SOURCE** ▶ Philips Fortimo LEDLine
- MODULE LIFETIME** ▶ Approx. 50.000 hours
- LED COOLING** ▶ Passive cooling
- DRIVER** ▶ Incl. standard Xitanium driver.
- COLORS (Δ)** ▶
 - 3 = RAL 9003 white
 - 5 = RAL 9005 black
 - 6 = RAL 9006 alu
- REFLECTOR PLATE** ▶ Clear Glass
- ADJUSTABLE** ▶ No
- SIZE** ▶ 434 X 434 X 154MM

OPTIONS

- COLORS** ▶ Available in all RAL colours on request
Additional price + 10%
- DIMMABLE** ▶ Dimmable or dali € 45,00

INFORMATION

- WARRANTY** ▶ 5 Years

Δ see colors

Keylight International B.V. reserves the right to modify or change technical, construction or LED specifications due to continuous improvements of our products and lightsources.



BIG STEEL

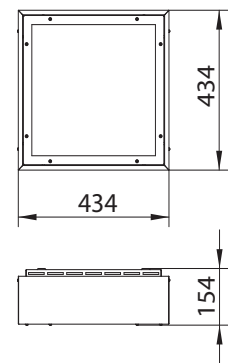

Technical drawing

| ARTICLE NO. | LAMP TYPE | BRAND | LIGHT OUTPUT | MODULE POWER | MODULE EFFICIENCY | CORRELATED COLOUR TEMPERATURE | COLOUR RENDERING INDEX | TC LIFE | SALES PRICE |
|--------------|-----------|---------|--------------|--------------|-------------------|-------------------------------|------------------------|---------|-------------|
| Δ see colors | | | LM | W | LM/W | K | RA | HRS | EURO |
| 4036.281.74Δ | LEDLine | Philips | 8000 | 2X 33 | 121 | 4000 | >70 | 50.000 | € 1260,00 |
| 4036.281.75Δ | LEDLine | Philips | 8000 | 2X 33 | 121 | 5700 | >70 | 50.000 | € 1260,00 |
| 4036.281.84Δ | LEDLine | Philips | 8000 | 2X 33 | 121 | 4000 | >80 | 50.000 | € 1260,00 |
| 4036.282.74Δ | LEDLine | Philips | 12.000 | 2X 49 | 121 | 4000 | >70 | 50.000 | € 1295,00 |
| 4036.282.75Δ | LEDLine | Philips | 12.000 | 2X 49 | 121 | 5700 | >70 | 50.000 | € 1295,00 |
| 4036.282.84Δ | LEDLine | Philips | 12.000 | 2X 49 | 121 | 4000 | >80 | 50.000 | € 1295,00 |

TECHNICAL INFORMATION

PRODUCT

AQUA LED



- PRODUCT MATERIAL** ▶ Aluminium
- LIGHT SOURCE** ▶ Philips LEDLine
- MODULE LIFETIME** ▶ Approx. 50.000 hours
- LED COOLING** ▶ Passive cooling
- DRIVER** ▶ Incl. standard Xitanium driver.
- COLORS (Δ)** ▶
 - 3 = RAL 9003 white
 - 5 = RAL 9005 black
 - 6 = RAL 9006 alu
- REFLECTOR PLATE** ▶
- ADJUSTABLE** ▶ No
- SIZE** ▶

OPTIONS

- DIMMABLE** ▶ Dimmable or dali on request

INFORMATION

- WARRANTY** ▶ 5 Years

Δ see colors

AQUA LED

Keylight International B.V. reserves the right to modify or change technical, construction or LED specifications due to continuous improvements of our products and lightsources.

Technical drawing

| ARTICLE NO. | LAMP TYPE | BRAND | LIGHT OUTPUT | MODULE POWER | MODULE EFFICIENCY | CORRELATED COLOUR TEMPERATURE | COLOUR RENDERING INDEX | TC LIFE | SALES PRICE |
|--------------|-----------|---------|--------------|--------------|-------------------|-------------------------------|------------------------|---------|-------------|
| Δ see colors | | | LM | W | LM/W | K | RA | HRS | EURO |
| Δ | LEDLine | Philips | 1350 | 16 | 84 | 3000 | >80 | 50.000 | € 650,00 |
| Δ | LEDLine | Philips | 1900 | 23 | 83 | 3000 | >80 | 50.000 | € 650,00 |
| Δ | LEDLine | Philips | 2500 | 33 | 76 | 3000 | >80 | 50.000 | € 650,00 |
| Δ | LEDLine | Philips | 1400 | 16 | 87 | 4000 | >80 | 50.000 | € 650,00 |
| Δ | LEDLine | Philips | 2000 | 23 | 87 | 4000 | >80 | 50.000 | € 650,00 |
| Δ | LEDLine | Philips | 2600 | 33 | 79 | 4000 | >80 | 50.000 | € 650,00 |



Exterior Wall Luminaires



SATURNUS IP
PAGE 1



STERLING
PAGE 1



BLOCK O
PAGE 1



BLOCK C UD
PAGE 1



BLOCK 10
PAGE 1



BLOCK 6 UD
PAGE 1



RUSS UD
PAGE 1



WALL 10 UD
PAGE 1



WALL 14
PAGE 1



WALL 17
PAGE 1



ATIM
PAGE 1



STYLO
PAGE 1

Exterior Wall Luminaires

| | |
|-------------|--------|
| ATIM | PAGE 1 |
| BLOCK C UD | PAGE 1 |
| BLOCK 10 | PAGE 1 |
| BLOCK 6 UD | PAGE 1 |
| BLOCK O | PAGE 1 |
| RUSS UD | PAGE 1 |
| SATURNUS IP | PAGE 1 |
| STERLING | PAGE 1 |
| STYLO | PAGE 1 |
| WALL 10 UD | PAGE 1 |
| WALL 14 | PAGE 1 |
| WALL 17 | PAGE 1 |

TECHNICAL INFORMATION

PRODUCT

SATURNUS IP



- PRODUCT MATERIAL** ▶ Aluminium
- LIGHT SOURCE** ▶ Cree XP-E
- MODULE LIFETIME** ▶ Approx. 30.000 hours
- VOLTAGE** ▶ 230v
- LED COOLING** ▶ Passive cooling
- DRIVER** ▶ Incl. driver.
- COLORS** ▶ ● 3 = RAL 9003 white
- BEAM ANGLE** ▶ Wide angle.
- SIZE** ▶ 50 X 50 X 59MM

INFORMATION

- WARRANTY** ▶ 3 Years

Incl. Frosted Glass.

Incl. 1.5m cable

Keylight International B.V. reserves the right to modify or change technical, construction or LED specifications due to continuous improvements of our products and lightsources.



SATURNUS

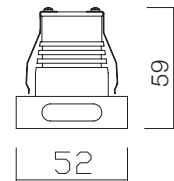

Technical drawing

| ARTICLE NO. | LAMP TYPE | BRAND | LIGHT OUTPUT | MODULE POWER | MODULE EFFICIENCY | CORRELATED COLOUR TEMPERATURE | COLOUR RENDERING INDEX | TC LIFE | SALES PRICE |
|----------------|-----------|-------|--------------|--------------|-------------------|-------------------------------|------------------------|---------|-------------|
| Δ see colors | | | LM | W | LM/W | K | RA | HRS | EURO |
| 8050.990.99.3Δ | XP-E | Cree | 75 | 2.4 | 30 | 2700 | >80 | 30.000 | € 75,00 |

TECHNICAL INFORMATION

PRODUCT

STERLING



- PRODUCT MATERIAL** ▶ Aluminium
- LIGHT SOURCE** ▶ Samsung LED
- MODULE LIFETIME** ▶ Approx. 30.000 hours
- VOLTAGE** ▶ 230v
- LED COOLING** ▶ Passive cooling
- DRIVER** ▶ Incl. driver.
- COLORS** ▶ ● 6 = RAL 9006 alu
- BEAM ANGLE** ▶ Wide angle.
- SIZE** ▶ 83 X 51 X 35MM

INFORMATION

- WARRANTY** ▶ 3 Years

Incl. Frosted Glass.

Incl. 1.5m cable

Incl. ABS mounting kit.

Keylight International B.V. reserves the right to modify or change technical, construction or LED specifications due to continuous improvements of our products and lightsources.

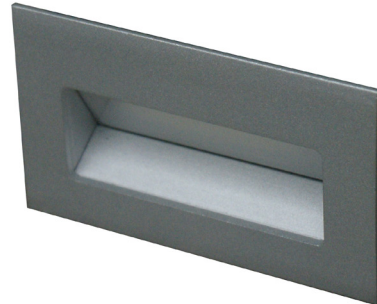

STERLING



| ARTICLE NO. | LAMP TYPE | BRAND | LIGHT OUTPUT | MODULE POWER | MODULE EFFICIENCY | CORRELATED COLOUR TEMPERATURE | COLOUR RENDERING INDEX | TC LIFE | SALES PRICE |
|----------------|-----------|---------|--------------|--------------|-------------------|-------------------------------|------------------------|---------|-------------|
| Δ see colors | | | LM | W | LM/W | K | RA | HRS | EURO |
| 8083.990.86.6Δ | LED | Samsung | 75 | 2.4 | 30 | 2700 | >80 | 30.000 | € 80,00 |

TECHNICAL INFORMATION

PRODUCT

BLOCK O



- PRODUCT MATERIAL** ▶ Die-cast aluminium
- LIGHT SOURCE** ▶ XP-E
- MODULE LIFETIME** ▶ Approx. 30.000 hours
- LED COOLING** ▶ Passive cooling
- DRIVER** ▶ Incl. driver.
- COLORS (Δ)** ▶
 - 3 = RAL 9003 white
 - 5 = RAL 9005 black
- BEAM ANGLE** ▶ 30°
- SIZE** ▶ 80 X 85 X 70MM

INFORMATION

- WARRANTY** ▶ 5 Years

Δ = product color code. See colors



BLOCK O

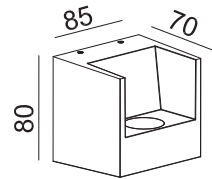

Technical drawing

Keylight International B.V. reserves the right to modify or change technical, construction or LED specifications due to continuous improvements of our products and lightsources.

| ARTICLE NO. | LAMP TYPE | BRAND | LIGHT OUTPUT | MODULE POWER | MODULE EFFICIENCY | CORRELATED COLOUR TEMPERATURE | COLOUR RENDERING INDEX | TC LIFE | mA | SALES PRICE |
|--------------|-----------|-------|--------------|--------------|-------------------|-------------------------------|------------------------|---------|-----|-------------|
| Δ see colors | | | LM | W | LM/W | K | RA | HRS | mA | EURO |
| 6800.990.30Δ | XP-E | Cree | 280 | 2.5 | 112 | 3000 | >80 | 30.000 | 700 | € 85,00 |

TECHNICAL INFORMATION

PRODUCT

BLOCK C UD



- PRODUCT MATERIAL** ▶ Die-cast aluminium
- LIGHT SOURCE** ▶ XP-E
- MODULE LIFETIME** ▶ Approx. 30.000 hours
- LED COOLING** ▶ Passive cooling
- DRIVER** ▶ Incl. driver.
- COLORS (Δ)** ▶
 - 3 = RAL 9003 white
 - 5 = RAL 9005 black
- BEAM ANGLE** ▶ 30°
- SIZE** ▶ 120 X 78 X 70MM

INFORMATION

- WARRANTY** ▶ 5 Years

Δ = product color code. See colors

Keylight International B.V. reserves the right to modify or change technical, construction or LED specifications due to continuous improvements of our products and lightsources.



BLOCK C UD

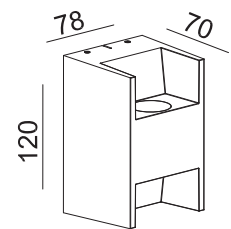

Technical drawing

| ARTICLE NO. | LAMP TYPE | BRAND | LIGHT OUTPUT | MODULE POWER | MODULE EFFICIENCY | CORRELATED COLOUR TEMPERATURE | COLOUR RENDERING INDEX | TC LIFE | mA | SALES PRICE |
|--------------|-----------|-------|--------------|--------------|-------------------|-------------------------------|------------------------|---------|-----|-------------|
| Δ see colors | | | LM | W | LM/W | K | RA | HRS | mA | EURO |
| 6013.990.30Δ | XP-E | Cree | 280 | 2 X 2.5 | 112 | 2700 | >80 | 30.000 | 700 | € 125,00 |

TECHNICAL INFORMATION

PRODUCT

BLOCK 10



- PRODUCT MATERIAL** ▶ Die-cast aluminium
- LIGHT SOURCE** ▶ Bridgelux V8
- MODULE LIFETIME** ▶ Approx. 30.000 hours
- LED COOLING** ▶ Passive cooling
- DRIVER** ▶ Incl. driver.
- COLORS (Δ)** ▶
 - 3 = RAL 9003 white
 - 5 = RAL 9005 black
 - 9 = Grey
- SIZE** ▶ 105 X 125 X 60MM

OPTIONS

- DIMMABLE** ▶ Dimmable build-in trailing edge € 55,00
art. no.: 0135.999.99

INFORMATION

- WARRANTY** ▶ 5 Years

Δ = product color code. See colors

Keylight International B.V. reserves the right to modify or change technical, construction or LED specifications due to continuous improvements of our products and lightsources.



BLOCK 10

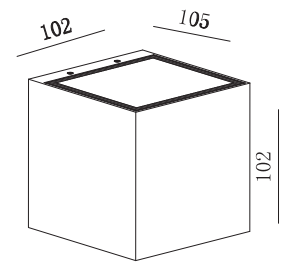

Technical drawing

| ARTICLE NO. | LAMP TYPE | BRAND | LIGHT OUTPUT | MODULE POWER | MODULE EFFICIENCY | CORRELATED COLOUR TEMPERATURE | COLOUR RENDERING INDEX | TC LIFE | mA | SALES PRICE |
|--------------|-----------|-----------|--------------|--------------|-------------------|-------------------------------|------------------------|---------|-------|-------------|
| Δ see colors | | | LM | W | LM/W | K | RA | HRS | | EURO |
| 6017.990.99Δ | V8 Array | Bridgelux | 565 | 6.2 | 91 | 2700 | >80 | 30.000 | 350MA | € 135,00 |

TECHNICAL INFORMATION

PRODUCT

BLOCK 6 UD



- PRODUCT MATERIAL** ▶ Die-cast aluminium
- LIGHT SOURCE** ▶ Bridgelux V6
- MODULE LIFETIME** ▶ Approx. 30.000 hours
- LED COOLING** ▶ Passive cooling
- DRIVER** ▶ Incl. driver.
- COLORS (Δ)** ▶ ● **5** = RAL 9005 black
 ◐ **9** = Grey
- SIZE** ▶ 105 X 125 X 60MM
- BEAM ANGLE** ▶ 2X 20°

OPTIONS

- DIMMABLE** ▶ Dimmable build-in trailing edge € 55,00
 art. no.: 0135.999.99

INFORMATION

- WARRANTY** ▶ 5 Years

Δ = product color code. See colors

Keylight International B.V. reserves the right to modify or change technical, construction or LED specifications due to continuous improvements of our products and lightsources.



BLOCK 6 UD

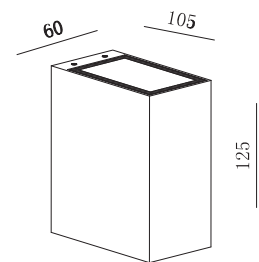

Technical drawing

| ARTICLE NO. | LAMP TYPE | BRAND | LIGHT OUTPUT | MODULE POWER | MODULE EFFICIENCY | CORRELATED COLOUR TEMPERATURE | COLOUR RENDERING INDEX | TC LIFE | mA | SALES PRICE |
|--------------|-----------|-----------|--------------|--------------|-------------------|-------------------------------|------------------------|---------|-------|-------------|
| Δ see colors | | | LM | W | LM/W | K | RA | HRS | | EURO |
| 6018.999.99Δ | V6 Array | Bridgelux | 2 X 420 | 2 X 4.6 | 104 | 2700 | >80 | 30.000 | 500MA | € 145,00 |

TECHNICAL INFORMATION

PRODUCT

RUSS UD



- PRODUCT MATERIAL** ▶ Aluminium
- LIGHT SOURCE** ▶ LED
- MODULE LIFETIME** ▶ Approx. 30.000 hours
- LED COOLING** ▶ Passive cooling
- DRIVER** ▶ Incl. driver.
- COLORS (Δ)** ▶
 - 3 = RAL 9003 white
 - 5 = RAL 9005 black
 - 9 = Grey
- SIZE** ▶ 143 X 103 X 93MM

INFORMATION

- WARRANTY** ▶ 5 Years

Δ = product color code. See colors



BOW UD

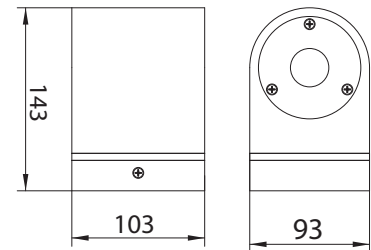

Technical drawing

Keylight International B.V. reserves the right to modify or change technical, construction or LED specifications due to continuous improvements of our products and lightsources.

| ARTICLE NO. | LAMP TYPE | BRAND | LIGHT OUTPUT | MODULE POWER | MODULE EFFICIENCY | CORRELATED COLOUR TEMPERATURE | COLOUR RENDERING INDEX | TC LIFE | SALES PRICE |
|--------------|-----------|-------|--------------|--------------|-------------------|-------------------------------|------------------------|---------|-------------|
| Δ see colors | | | LM | W | LM/W | K | RA | HRS | EURO |
| 6020.830.20Δ | CR | Cree | 2 X 300 | 6 | 50 | 3000 | >80 | 30.000 | € 350,00 |
| 6020.840.20Δ | CR | Cree | 2 x 300 | 6 | 50 | 4000 | >80 | 30.000 | € 350,00 |

TECHNICAL INFORMATION

PRODUCT

WALL 10 UD



- PRODUCT MATERIAL** ▶ Aluminium
- LIGHT SOURCE** ▶ MasterLED
- MODULE LIFETIME** ▶ Approx. 40.000 hours
- LED COOLING** ▶ Passive cooling
- COLORS (Δ)** ▶
 - 3 = RAL 9003 white
 - 5 = RAL 9005 black
 - 6 = RAL 9006 alu
- BEAM ANGLE** ▶ 25° / 40°
- SIZE** ▶ L: 182 X B: 136 X D: 100MM

OPTIONS

- COLORS** ▶ Available in all RAL colours on request.
Additional price + 10%

INFORMATION

- WARRANTY** ▶ 5 Years

Δ = product color code. See colors

Without lightsource

Keylight International B.V. reserves the right to modify or change technical, construction or LED specifications due to continuous improvements of our products and lightsources.



WALL 10 UD

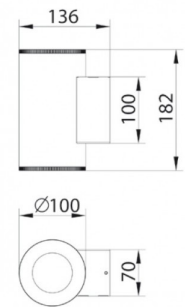

Technical drawing

| ARTICLE NO. | LAMP TYPE | BRAND | LIGHT OUTPUT | MODULE POWER | MODULE EFFICIENCY | CORRELATED COLOUR TEMPERATURE | COLOUR RENDERING INDEX | TC LIFE | BEAM ANGLE | SALES PRICE |
|--------------|-----------|---------|--------------|--------------|-------------------|-------------------------------|------------------------|---------|------------|-------------|
| Δ see colors | | | LM | W | LM/W | K | RA | HRS | ° | EURO |
| 8100.601.99Δ | MasterLED | Philips | 2X 410 | 16 | 54 | 2700 | >80 | 40.000 | 25° | € 265,00 |
| 8100.602.99Δ | MasterLED | Philips | 2X 410 | 16 | 54 | 2700 | >80 | 40.000 | 40° | € 265,00 |
| 8100.603.99Δ | MasterLED | Philips | 2X 450 | 16 | 56 | 3000 | >80 | 40.000 | 25° | € 265,00 |
| 8100.604.99Δ | MasterLED | Philips | 2X 450 | 16 | 56 | 3000 | >80 | 40.000 | 40° | € 265,00 |
| 8100.605.99Δ | MasterLED | Philips | 2X 460 | 16 | 56 | 4000 | >80 | 40.000 | 25° | € 265,00 |
| 8100.606.99Δ | MasterLED | Philips | 2X 460 | 16 | 56 | 4000 | >80 | 40.000 | 40° | € 265,00 |

TECHNICAL INFORMATION

PRODUCT

WALL 14



- PRODUCT MATERIAL** ▶ Aluminium
- LIGHT SOURCE** ▶ Masterled
- MODULE LIFETIME** ▶ Approx. 40.000 hours
- LED COOLING** ▶ Passive cooling
- COLORS (Δ)** ▶
 - 3 = RAL 9003 white
 - 5 = RAL 9005 black
 - 6 = RAL 9006 alu
- BEAM ANGLE** ▶ 25° / 40°
- SIZE** ▶ 195 X 178MM

OPTIONS

- COLORS** ▶ Available in all RAL colours on request.
Additional price + 10%

INFORMATION

- WARRANTY** ▶ 5 Years

Δ = product color code. See colors

Without lightsource

Keylight International B.V. reserves the right to modify or change technical, construction or LED specifications due to continuous improvements of our products and lightsources.



WALL 14

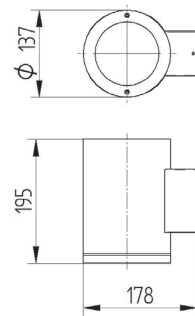

Technical drawing

| ARTICLE NO. | LAMP TYPE | BRAND | LIGHT OUTPUT | MODULE POWER | MODULE EFFICIENCY | CORRELATED COLOUR TEMPERATURE | COLOUR RENDERING INDEX | TC LIFE | | SALES PRICE |
|--------------|-----------|---------|--------------|--------------|-------------------|-------------------------------|------------------------|---------|-----|-------------|
| Δ see colors | | | LM | W | LM/W | K | RA | HRS | ° | EURO |
| 8137.601.99Δ | Masterled | Philips | 410 | 8 | 54 | 2700 | >80 | 40.000 | 25° | € 210,00 |
| 8137.602.99Δ | Masterled | Philips | 410 | 8 | 54 | 2700 | >80 | 40.000 | 40° | € 210,00 |
| 8137.603.99Δ | Masterled | Philips | 450 | 8 | 56 | 3000 | >80 | 40.000 | 25° | € 210,00 |
| 8137.604.99Δ | Masterled | Philips | 450 | 8 | 56 | 3000 | >80 | 40.000 | 40° | € 210,00 |
| 8137.605.99Δ | Masterled | Philips | 460 | 8 | 56 | 4000 | >80 | 40.000 | 25° | € 210,00 |
| 8137.606.99Δ | Masterled | Philips | 460 | 8 | 56 | 4000 | >80 | 40.000 | 40° | € 210,00 |

TECHNICAL INFORMATION

PRODUCT

WALL 17



- PRODUCT MATERIAL** ▶ Aluminium
- LIGHT SOURCE** ▶ DLM G5
- MODULE LIFETIME** ▶ Approx. 50.000 hours
- LED COOLING** ▶ Passive cooling
- DRIVER DLM** ▶ Incl. standard titanium driver.
- COLORS** ▶
 - 3 = RAL 9003 white
 - 5 = RAL 9005 black
 - 6 = RAL 9006 alu
- BEAM ANGLE** ▶ 60°
- ADJUSTABLE** ▶ No
- SIZE** ▶ 189 X 175MM

OPTIONS

- COLORS** ▶ Available in all RAL colours on request
Additional price + 10%
- DIMMABLE** ▶ DLM: Dimmable or dali € 45,00

INFORMATION

- WARRANTY** ▶ 5 Years

Δ see colors

Keylight International B.V. reserves the right to modify or change technical, construction or LED specifications due to continuous improvements of our products and lightsources.

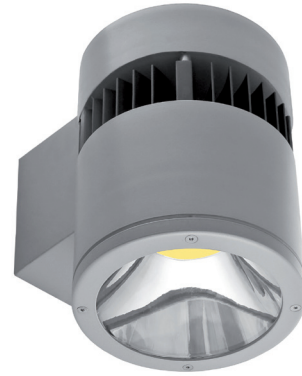

WALL 17

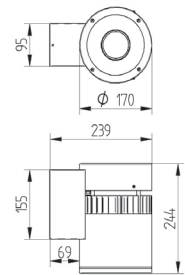

Technical drawing

| ARTICLE NO. | LAMP TYPE | BRAND | LIGHT OUTPUT | MODULE POWER | MODULE EFFICIENCY | CORRELATED COLOUR TEMPERATURE | COLOUR RENDERING INDEX | TC LIFE | POWER FACTOR | SALES PRICE |
|--------------|-----------|---------|--------------|--------------|-------------------|-------------------------------|------------------------|---------|--------------|-------------|
| Δ see colors | | | LM | W | LM/W | K | RA | HRS | PF | EURO |
| 8239.101.60Δ | DLM G5 | Philips | 1100 | 11 | 100 | 3000 | >80 | 50.000 | >,09 | € 360,00 |
| 8239.102.60Δ | DLM G5 | Philips | 1100 | 10 | 110 | 4000 | >80 | 50.000 | >,09 | € 360,00 |
| 8239.103.60Δ | DLM G5 | Philips | 2000 | 21 | 95 | 3000 | >80 | 50.000 | >,09 | € 370,00 |
| 8239.104.60Δ | DLM G5 | Philips | 2000 | 19 | 105 | 3000 | >80 | 50.000 | >,09 | € 370,00 |
| 8239.105.60Δ | DLM G5 | Philips | 3000 | 32 | 94 | 3000 | >80 | 50.000 | >,09 | € 380,00 |
| 8239.106.60Δ | DLM G5 | Philips | 3000 | 29 | 103 | 4000 | >80 | 50.000 | >,09 | € 380,00 |

TECHNICAL INFORMATION

PRODUCT

ATIM



- PRODUCT MATERIAL** ▶ Stainless Steel & Aluminium
- LIGHT SOURCE** ▶ Osram LEDPlate
- MODULE LIFETIME** ▶ Approx. 50.000 hours
- LED COOLING** ▶ Passive cooling
- DRIVER** ▶ Incl. standard Osram driver.
- COLORS (Δ)** ▶
 - 3 = RAL 9003 white
 - 5 = RAL 9005 black
 - 6 = RAL 9006 alu
- REFLECTOR PLATE** ▶ Clear Glass
- ADJUSTABLE** ▶ No
- SIZE** ▶ 411 X 301 X 301MM

OPTIONS

- COLORS** ▶ Available in all RAL colours on request
Additional price + 10%
- DIMMABLE** ▶ Dimmable or dali € 45,00

INFORMATION

- WARRANTY** ▶ 5 Years

Δ see colors

Keylight International B.V. reserves the right to modify or change technical, construction or LED specifications due to continuous improvements of our products and lightsources.



ATIM

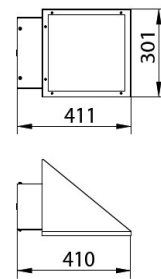

Technical drawing

| ARTICLE NO. | LAMP TYPE | BRAND | LIGHT OUTPUT | MODULE POWER | MODULE EFFICIENCY | CORRELATED COLOUR TEMPERATURE | COLOUR RENDERING INDEX | TC LIFE | SALES PRICE |
|--------------|-----------|-------|--------------|--------------|-------------------|-------------------------------|------------------------|---------|-------------|
| Δ see colors | | | LM | W | LM/W | K | RA | HRS | EURO |
| 8243.181.91Δ | LEDPlate | Osram | 1350 | 16 | 84 | 3000 | >80 | 50.000 | € 630,00 |
| 8243.182.91Δ | LEDPlate | Osram | 1900 | 23 | 83 | 3000 | >80 | 50.000 | € 630,00 |
| 8243.183.91Δ | LEDPlate | Osram | 2500 | 33 | 76 | 3000 | >80 | 50.000 | € 630,00 |
| 8243.184.91Δ | LEDPlate | Osram | 1400 | 16 | 87 | 4000 | >80 | 50.000 | € 630,00 |
| 8243.185.91Δ | LEDPlate | Osram | 2000 | 23 | 87 | 4000 | >80 | 50.000 | € 630,00 |
| 8243.186.91Δ | LEDPlate | Osram | 2600 | 33 | 79 | 4000 | >80 | 50.000 | € 630,00 |

TECHNICAL INFORMATION

PRODUCT

STYLO



- PRODUCT MATERIAL** ▶ Aluminium body
- LIGHT SOURCE** ▶ LED Plate
- MODULE LIFETIME** ▶ Approx. 50.000 hours
- LED COOLING** ▶ Passive cooling
- DRIVER** ▶ LED Driver
- COLORS (Δ)** ▶
 - 3 = RAL 9003 white
 - 5 = RAL 9005 black
 - 6 = RAL 9006 alu
- REFLECTOR PLATE** ▶ Opal diffuser
- ADJUSTABLE** ▶ No
- SIZE (STYLO)** ▶ 411 X 301 X 301MM
- SIZE (STYLO H)** ▶ 411 X 301 X 301MM
- SIZE (STYLO X)** ▶ 411 X 301 X 301MM

OPTIONS

- COLORS** ▶ Available in all RAL colours on request
Additional price + 10%
- DIMMABLE** ▶ Dimmable or dali € 45,00

INFORMATION

- WARRANTY** ▶ 5 Years

Δ see colors

Keylight International B.V. reserves the right to modify or change technical, construction or LED specifications due to continuous improvements of our products and lightsources.



STYLO H



STYLO X

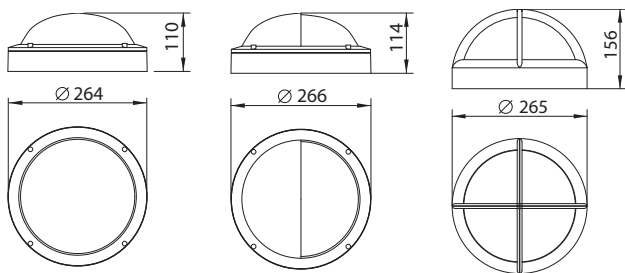

Stylo

Stylo H

Stylo X

| ARTICLE NO. | PRODUCT | BRAND | LIGHT OUTPUT | MODULE POWER | MODULE EFFICIENCY | CORRELATED COLOUR TEMPERATURE | COLOUR RENDERING INDEX | TC LIFE | SALES PRICE |
|--------------|---------|-----------|--------------|--------------|-------------------|-------------------------------|------------------------|---------|-------------|
| Δ see colors | | | LM | W | LM/W | K | RA | HRS | EURO |
| 8244.181.83Δ | Stylo | LED Plate | 1300 | 12 | 108 | 3000 | >80 | 50.000 | € 275,00 |
| 8244.181.84Δ | Stylo | LED Plate | 1300 | 11 | 108 | 4000 | >80 | 50.000 | € 275,00 |
| 8245.181.83Δ | Stylo H | LED Plate | 1300 | 12 | 108 | 3000 | >80 | 50.000 | € 280,00 |
| 8245.181.84Δ | Stylo H | LED Plate | 1300 | 11 | 108 | 4000 | >80 | 50.000 | € 280,00 |
| 8246.181.83Δ | Stylo X | LED Plate | 1300 | 12 | 108 | 3000 | >80 | 50.000 | € 285,00 |
| 8246.181.84Δ | Stylo X | LED Plate | 1300 | 11 | 108 | 4000 | >80 | 50.000 | € 285,00 |



Exterior Luminaires



FLOOR 6
PAGE 1



FLOOR 10
PAGE 1



GARDEN SPOT
PAGE 1



FLOOD 10 / 30 / 40
PAGE 1



PILE
PAGE 1



SWEEP
PAGE 1

Exterior Outdoor Luminaires

| | |
|--------------------|--------|
| FLOOD 10 / 30 / 40 | PAGE 1 |
| FLOOR 6 | PAGE 1 |
| FLOOR 10 | PAGE 1 |
| GARDEN SPOT | PAGE 1 |
| HIGH BAY | PAGE 1 |
| PILE | PAGE 1 |
| SWEEP | PAGE 1 |

TECHNICAL INFORMATION

PRODUCT

FLOOR 6



- PRODUCT MATERIAL** ▶ Aluminium & Stainless steel.
- LIGHT SOURCE** ▶ XP-E
- MODULE LIFETIME** ▶ Approx. 30.000 hours
- LED COOLING** ▶ Passive cooling
- DRIVER** ▶ Incl. driver.
- COLORS** ▶ ● 5 = RAL 9005 black / Stainless steel.
- BEAM ANGLE** ▶ 40°
- SIZE FLOOD 6** ▶ 65 X 65 X 148MM

WARRANTY ▶ 3 Years

IP67 fixture!

Frosted glass.

Incl. 1.5m cable.

Incl. Ground tube.



FLOOR 6

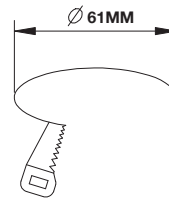

Hole size

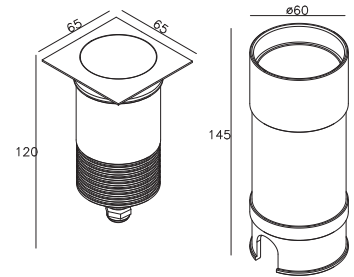

Technical drawing

Keylight International B.V. reserves the right to modify or change technical, construction or LED specifications due to continuous improvements of our products and lightsources.

| ARTICLE NO. | LAMP TYPE | BRAND | LIGHT OUTPUT | MODULE POWER | MODULE EFFICIENCY | CORRELATED COLOUR TEMPERATURE | COLOUR RENDERING INDEX | TC LIFE | SALES PRICE |
|---------------|-----------|-------|--------------|--------------|-------------------|-------------------------------|------------------------|---------|-------------|
| | | | LM | W | LM/W | K | RA | HRS | EURO |
| 8065.990.40.8 | XP-E | Cree | 75 | 3X 1.2 | 25 | 2700 | >80 | 30.000 | € 149,00 |

TECHNICAL INFORMATION

PRODUCT

FLOOR 10



- PRODUCT MATERIAL** ▶ Stainless steel & ABS plastics
- LIGHT SOURCE** ▶ XP-E
- MODULE LIFETIME** ▶ Approx. 30.000 hours
- LED COOLING** ▶ Passive cooling
- DRIVER** ▶ Incl. driver.
- COLORS** ▶ ● 8 = Stainless steel
- BEAM ANGLE** ▶ 40°
- SIZE FLOOD 10** ▶ 108 X 180 X 159MM

OPTIONS

- DIMMABLE** ▶ Dimmable on request

INFORMATION

- WARRANTY** ▶ 3 Years

Tempered glass standard

Lens plate black colored and adjustable. Incl. 1.5m cable.

Stainless steel ring (316)

Keylight International B.V. reserves the right to modify or change technical, construction or LED specifications due to continuous improvements of our products and lightsources.



FLOOR 10

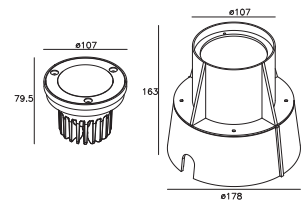

Technical drawing

| ARTICLE NO. | LAMP TYPE | BRAND | LIGHT OUTPUT | MODULE POWER | MODULE EFFICIENCY | CORRELATED COLOUR TEMPERATURE | COLOUR RENDERING INDEX | TC LIFE | mA | SALES PRICE |
|---------------|-----------|-------|--------------|--------------|-------------------|-------------------------------|------------------------|---------|---------|-------------|
| | | | LM | W | LM/W | K | RA | HRS | | EURO |
| 8108.990.30.8 | XP-E | Cree | | 3X 2.4 | | 2700 | >80 | 30.000 | 700/12V | € 195,00 |

TECHNICAL INFORMATION

PRODUCT

GARDEN SPOT



- PRODUCT MATERIAL** ▶ Aluminium
- LIGHT SOURCE** ▶ XP-E
- MODULE LIFETIME** ▶ Approx. 30.000 hours
- LED COOLING** ▶ Passive cooling
- DRIVER** ▶ Incl. driver.
- COLORS** ▶ ● 5 = RAL 9005 black
- BEAM ANGLE** ▶ 40°
- SIZE FLOOD 10** ▶ 142 X 68MM

OPTIONS

- ACCESSOIRES** ▶ including mounting plate and rod approx. 1m

INFORMATION

- WARRANTY** ▶ 3 Years

Incl. 1.5m cable.

Keylight International B.V. reserves the right to modify or change technical, construction or LED specifications due to continuous improvements of our products and lightsources.



GARDEN SPOT

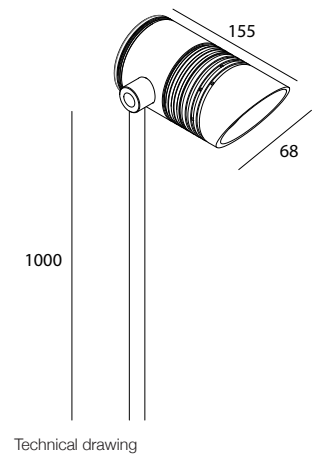

Technical drawing

| ARTICLE NO. | LAMP TYPE | BRAND | LIGHT OUTPUT | MODULE POWER | MODULE EFFICIENCY | CORRELATED COLOUR TEMPERATURE | COLOUR RENDERING INDEX | TC LIFE | mA | SALES PRICE |
|---------------|-----------|-------|--------------|--------------|-------------------|-------------------------------|------------------------|---------|-----|-------------|
| | | | LM | W | LM/W | K | RA | HRS | MA | EURO |
| 8142.990.30.5 | XP-E | Cree | | 3X 1.2 | | 2700 | >80 | 30.000 | 350 | € 175,00 |

TECHNICAL INFORMATION

PRODUCT

FLOOD 10/30/40



- PRODUCT MATERIAL** ▶ Die-cast aluminium
- LIGHT SOURCE** ▶ LED
- MODULE LIFETIME** ▶ Approx. 30.000 hours
- LED COOLING** ▶ Passive cooling
- DRIVER** ▶ Incl. driver.
- COLORS** ▶ ● 5 = RAL 9005 black
- BEAM ANGLE** ▶ 90°
- SIZE FLOOD 10** ▶ 196 X 150 X 53MM
- SIZE FLOOD 30** ▶ 292 X 250 X 80MM
- SIZE FLOOD 40** ▶ 356 X 325 X 106MM

INFORMATION

- WARRANTY** ▶ 3 Years

Tempered glass standard



FLOOD 10/30/40

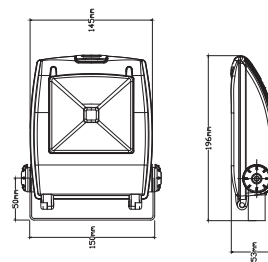

Flood 10

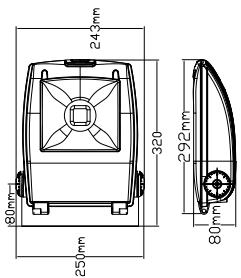

Flood 30

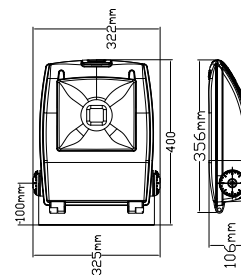

Flood 40

Keylight International B.V. reserves the right to modify or change technical, construction or LED specifications due to continuous improvements of our products and lightsources.

| ARTICLE NO. | LAMP TYPE | BRAND | LIGHT OUTPUT | MODULE POWER | MODULE EFFICIENCY | CORRELATED COLOUR TEMPERATURE | COLOUR RENDERING INDEX | TC LIFE | SALES PRICE |
|---------------|-----------|---------|--------------|--------------|-------------------|-------------------------------|------------------------|---------|-------------|
| | | | | | | | | | |
| 8016.930.93.5 | LED | Epistar | 900 | 10 | 90 | 3000 | >85 | 30.000 | € 75,00 |
| 8025.930.93.5 | LED | Epistar | 2700 | 30 | 90 | 3000 | >85 | 30.000 | € 165,00 |
| 8032.930.93.5 | LED | Epistar | 4500 | 50 | 90 | 3000 | >85 | 30.000 | € 270,00 |

TECHNICAL INFORMATION

PRODUCT

PILE



- PRODUCT MATERIAL** ▶ Aluminium
- LIGHT SOURCE** ▶ Philips DLM
- MODULE LIFETIME** ▶ Approx. 50.000 hours
- LED COOLING** ▶ Passive cooling
- DRIVER** ▶ Incl. Xitanium driver.
- COLORS** ▶
 - 3 = RAL 9003 white
 - 5 = RAL 9005 black
 - 6 = RAL 9006 alu
- BEAM ANGLE** ▶ Wide angle.
- SIZE** ▶ 200 X 1000 / 1500 / 3000MM

OPTIONS

- COLORS** ▶ Available in all RAL colours on request
Additional price + 10%

INFORMATION

- WARRANTY** ▶ 5 Years

Incl. Frosted Glass.

Incl. 1.5m cable

Keylight International B.V. reserves the right to modify or change technical, construction or LED specifications due to continuous improvements of our products and lightsources.



PILE

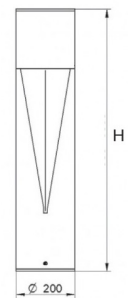

Technical drawing

| ARTICLE NO. | LAMP TYPE | BRAND | LIGHT OUTPUT | MODULE POWER | MODULE EFFICIENCY | CORRELATED COLOUR TEMPERATURE | COLOUR RENDERING INDEX | TC LIFE | SIZE | SALES PRICE |
|--------------|-----------|---------|--------------|--------------|-------------------|-------------------------------|------------------------|---------|--------|-------------|
| Δ see colors | | | LM | W | LM/W | K | RA | HRS | HEIGHT | EURO |
| 8020.105.60Δ | DLM G5 | Philips | 3000 | 32 | 94 | 3000 | >80 | 50.000 | 1000MM | € 1575,00 |
| 8020.106.60Δ | DLM G5 | Philips | 3000 | 29 | 103 | 4000 | >80 | 50.000 | 1000MM | € 1575,00 |
| 8021.105.60Δ | DLM G5 | Philips | 3000 | 32 | 94 | 3000 | >80 | 50.000 | 1500MM | € 2100,00 |
| 8021.106.60Δ | DLM G5 | Philips | 3000 | 29 | 103 | 4000 | >80 | 50.000 | 1500MM | € 2100,00 |
| 8022.105.60Δ | DLM G5 | Philips | 3000 | 32 | 94 | 3000 | >80 | 50.000 | 3000MM | € 2800,00 |
| 8022.106.60Δ | DLM G5 | Philips | 3000 | 29 | 103 | 4000 | >80 | 50.000 | 3000MM | € 2800,00 |

TECHNICAL INFORMATION

PRODUCT

SWEEP



- PRODUCT MATERIAL** ▶ Aluminium
- LIGHT SOURCE** ▶ SLM G4
- MODULE LIFETIME** ▶ Approx. 50.000 hours
- LED COOLING** ▶ Passive cooling
- DRIVER** ▶ Incl. Xitanium driver.
- COLORS (Δ)** ▶
 - 3 = RAL 9003 white
 - 5 = RAL 9005 black
 - 6 = RAL 9006 alu
- BEAM ANGLE** ▶ WIDE ANGLE
- ADJUSTABLE** ▶ Yes
- SIZE** ▶ 140 X 1006 X MM

OPTIONS

- COLORS** ▶ Available in all RAL colours on request
Additional price + 10%

INFORMATION

- WARRANTY** ▶ 5 Years

Δ = product color code. See colors

Keylight International B.V. reserves the right to modify or change technical, construction or LED specifications due to continuous improvements of our products and lightsources.



SWEEP

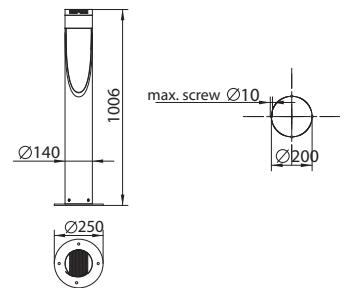

Technical drawing

| ARTICLE NO. | TYPE | LED TYPE | BRAND | LIGHT OUTPUT | MODULE POWER | MODULE EFFICIENCY | CORRELATED COLOUR TEMPERATURE | COLOUR RENDERING INDEX | TC LIFE | SALES PRICE |
|--------------|--------------|----------|---------|--------------|--------------|-------------------|-------------------------------|------------------------|---------|-------------|
| Δ see colors | | | | LM | W | LM/W | K | RA | HRS | EURO |
| 8024.112.24Δ | SLM 1100-830 | G4 | Philips | 1100 | 10 | 124 | 3000 | 82 | 50.000 | € 865,00 |
| 8024.113.24Δ | SLM 1100-840 | G4 | Philips | 1100 | 10 | 139 | 4000 | 82 | 50.000 | € 865,00 |
| 8024.111.24Δ | SLM 1100-927 | G4 | Philips | 1100 | 10 | 97 | 2700 | 97 | 50.000 | € 865,00 |
| 8024.131.24Δ | SLM 1100-930 | G4 | Philips | 1100 | 10 | 100 | 3000 | 97 | 50.000 | € 865,00 |
| 8024.132.24Δ | SLM 1100-940 | G4 | Philips | 1100 | 10 | 124 | 3000 | 82 | 50.000 | € 875,00 |
| 8024.114.24Δ | SLM 2000-830 | G4 | Philips | 2000 | 17 | 119 | 3000 | 82 | 50.000 | € 875,00 |
| 8024.116.24Δ | SLM 2000-840 | G4 | Philips | 2000 | 17 | 126 | 4000 | 82 | 50.000 | € 875,00 |
| 8024.125.24Δ | SLM 2000-927 | G4 | Philips | 2000 | 17 | 92 | 2700 | 97 | 50.000 | € 875,00 |
| 8024.120.24Δ | SLM 2000-930 | G4 | Philips | 2000 | 17 | 97 | 3000 | 97 | 50.000 | € 875,00 |
| 8024.144.24Δ | SLM 2000-940 | G4 | Philips | 2000 | 17 | 104 | 3000 | 82 | 50.000 | € 875,00 |

Terms & Conditions.

Orders < Nett €100,- Handling Charge €10,-.

Free delivery the Netherlands > €500,-.

Orders in the Netherlands < €500,- transportcosts €12,50 per order and/or €40,- per pallet.

Export transportcosts: ex. works Nijkerk the Netherlands.

Product price including: Ballast, Driver, Led module.

Sales pricelist: Gross prices, excluding vat, excluding bulbs and waste disposal charge.

This pricelist replaces all previous pricelists issued, price changes reserved. Valid from 01-01-2013.

The general sales conditions of Keylight are applied.

Keylight has the right to change the technical aspects of the products and prices at any time without notice.

All the Keylight products are supplied without bulbs (except LED).

For technical information, please see www.key-light.nl

Development, product design: Keylight and partners.

Realisation and concept: Keylight.

Copyright Keylight International B.V. 2014 © All rights reserved.

Keylight International B.V.

Patroonstraat 11

3861 RN Nijkerk (GLD)

the Netherlands

Tel. +31(0)33 - 2462021

Fax. +31(0)33 - 2461430

Email info@key-light.nl

Web. www.key-light.nl

Chamber of commerce no. 32106968

VAT No. NL 814176744 B01

RABO IBAN NL11 RABO 0337 8109 90

RABO BIC: RABONL2U

